

Maintenance Manual for Embroidery Machine

HCS3-1201-30

Version 1.0



HappyJapan

HappyJapan Inc.

For safe adjustment and repair

In order to conduct adjustment and repair safely and surely,
please be sure to abide by what is mentioned in this manual to prevent trouble.



1. When you conduct adjustment and repair of this embroidery machine or handle electric related parts, you are required to take technical lesson in advance.
2. When you conduct adjustment and repair using this manual, please be sure to use together with instruction with it in hand.

Please conduct in accordance with work process in this manual.

In case there are no specific instructions or explanations in work process.
please be sure to unplug cord from receptacle.

When you exchange parts, please be sure to use genuine parts designated by us.

Please never remodel the embroidery machine.

When you handle circuit boards:

In order to prevent troubles from static electricity, please remove earth from human body.

Please don't touch metal part of circuit board with bare hand as it will short-circuit
and threaten to break circuit boards.

When you removed circuits boards from the machine or you store or transport them,
please wrap them in static electricity preventive bag and avoid to give shock.

Index

	page
For safe adjustment and repair	2
Index	3
Special tool, Measuring equipment, Other	7
1 Outline of mechanism	
1-1 Outline of mechanical mechanism	10
1-2 Placement of key electronic parts	12
2 Outer covers	
2-1 Removal of outer covers	13
3 Mechanical mechanism	
3-1 Basic maintenance	
3-1-1 Maintenance of thread path	18
3-1-2 Fixing of needle	20
3-1-3 Selection of thread	21
3-1-4 Relation between needle and upper thread	22
3-2 Fixed head	
3-2-1 Exchange of crank	23
3-2-2 Exchange of rod	27
3-2-3 Adjustment of the lowest needle point	28
3-2-4 Exchange of needle bar driver	29
3-2-5 Adjustment of fixing of jump device	31
3-2-6 Exchange of take-up lever cam	33
3-2-7 Exchange of roller shaft ass'y	34
3-2-8 Adjustment of take-up lever timing	35
3-2-9 Exchange of pressure foot cam	36
3-2-10 Check of height of pressure foot	37
3-2-11 Exchange of pressure foot	38
3-2-12 Adjustment of height of pressure foot guide bar	39
3-2-13 Exchange of pressure foot link and block	40
3-2-14 Exchange of pressure foot drive lever	41
3-2-15 Exchange of pressure foot guide	44
3-2-16 Exchange of pulse motor for pressure foot	45
3-2-17 Adjustment of pressure foot bracket ass'y	47

Index

	page
3-2-18 Exchange of thread catcher	48
3-2-21 Adjustment of bobbin winder.....	50
3-3 Moving head	
3-3-1 Assemble the upper rail of moving head.....	52
3-3-2 Adjustment of backlash (back and forth) of moving head	53
3-3-3 Assemble the moving head	54
3-3-4 Adjustment of needle position (back and forth)	58
3-3-5 Check of needle position.....	59
3-3-6 Adjustment of needle height.....	60
3-3-7 Exchange of needle bar and needle bar spring	62
3-3-8 Fixing of needle bar boss guide plate	64
3-3-9 Exchange of take-up lever	66
3-3-10 Exchange of thread adjusting spring	67
3-3-11 Adjustment of tension of thread adjusting spring	68
3-3-12 Adjustment of laser pointer	69
3-3-13 Adjustment of thread holder	70
3-3-14 Exchange of majic-tape on thread holder.....	72
3-4 Needle bar change unit	
3-4-1 Fixing of needle bar change unit	73
3-5 Rotary hook	
3-5-1 Adjustment of rotary hook timing	75
3-5-2 Adjustment of retainer on rotary hook	77
3-6 Thread cut unit	
3-6-1 Assemble the arm ass'y.....	78
3-6-2 Exchange of pulse motor for thread cutting driver	80
3-6-3 Exchange of bobbin thread holder	8Fæ
3-6-6 Exchange of moving knife	82
3-6-7 Exchange of fixed knife	83
3-6-8 Adjustment of moving knife and fixed knife	84
3-6-9 Adjustment of position of moving knife	85
3-6-10 Adjustment of bobbin thread holder	87
3-6-11 Exchange of keeper solenoid	88
3-6-12 Adjustment of position of keeper	89

Index

	page
3-7 Carriage unit	
3-7-1 Adjustment of X carriage belt tension	90
3-7-2 Exchange of X carriage belt	92
3-7-3 Adjustment of Y carriage belt tension	95
3-7-4 Exchange of Y carriage belt	97
3-8 Transmission unit	
3-8-1 Adjustment of timing belt tension	99
3-8-2 Exchange of timing belt	100
3-8-3 Adjustment of motor belt tension	102
3-8-4 Exchange of motor and motor belt	104
4 Electricity	
4-1 Circuit board related parts	
4-1-1 Remove LCD and LCD-T board	106
4-1-2 Setting for LCD-T board	108
4-1-3 Setting for power supply	109
4-2 Sensors	
4-2-1 Adjustment of upper shaft timing (C point / L point)	110
4-2-2 Adjustment of TC board	111
4-2-3 Adjustment of stop position of needle bar change unit	111
4-3 Inverter	
4-3-1 Remove of Inverter	112
4-3-2 Inverter Installation	114
4-3-3 How to set inverter	117
4-3-4 Initialization of parameter	119
4-4 Initialization of system	
4-4-1 Program update procedure	120
4-4-2 Preparation for program update	121
4-4-3 Program update	122
4-4-4 Initialization / Initialize of machine speed	123
4-5 Maintenance mode.	
4-5-1 How to enter maintenance mode	124

Index

	Page
4-5-2 Machine Test—Machine movement	125
4-5-3 Memory All Clear—Initialization of memory	127
4-5-4 Record — Opereration data display	128
4-5-4-1 Total number of stitch	128
4-5-4-2 Record of Error occurrence	129
4-5-4-3 Number of occurrence in each error display	130
4-5-4-4 Thread break history	131
4-5-4-5 Machine setting	132
4-5-4-6 Maintenance Register—Registration of machine maintenance date	133
4-5-4-7 Machine Setting Navigation after exchanging CONT board	134
5 Electrical connection diagram	136
6 Explanation of function of circuit board	141
7 Others	
7-1 How to respond for some question (As example step)	147
7-2 Trouble shooting	
7-2-1 Electricity doesn't turn on	148
7-2-2 Thread break	149
7-2-3 Erraneous thread cut	154
7-2-4 Off-registration of pattern	156
7-2-5 Upper thread comes off from needle hole	158
7-2-6 Upper thread remains	160
7-2-7 Malfunction of thread break detection	161
7-2-8 Suspension of upper shaft	163
7-2-9 Malfunction of needle bar change	164
7-2-10 Defect on thread catcher	165
7-2-11 Others (Mechanical)	166
7-2-12 Others (Electronically)	167
7-3 Error	
7-3-1 Startup error and measure	158
7-3-2 Error and measure	169
7-4 Reference date	
7-4-1 Tables for timing / adjustment value	172
7-4-2 Use TAJIMA made tubular frame	173

Special tool, Measuring equipment, Other

EJIG-R40

Keeper positioning jig)



HSA90050

Bering positioning gauge [4.85mm]

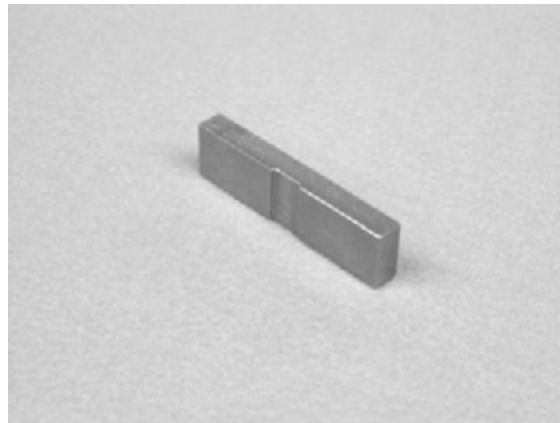

Special tool, Measuring equipment, Other

HSA90080

Retainer positioning gauge [0.8mm]



HSA90200

0.03mm thickness gauge



HSA90090

Positioning pin

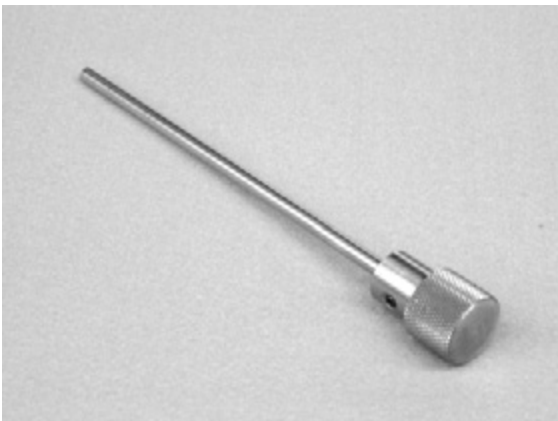

HSA90230

Tensile gauge



HSA90131

1.2mm thickness gauge



Special tool, Measuring equipment, Other

HSA90240

Dial-gauge set

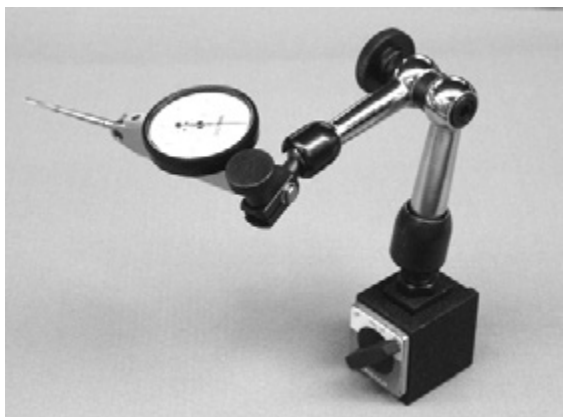

HSA90270

Vernier calliper gauge [200mm]

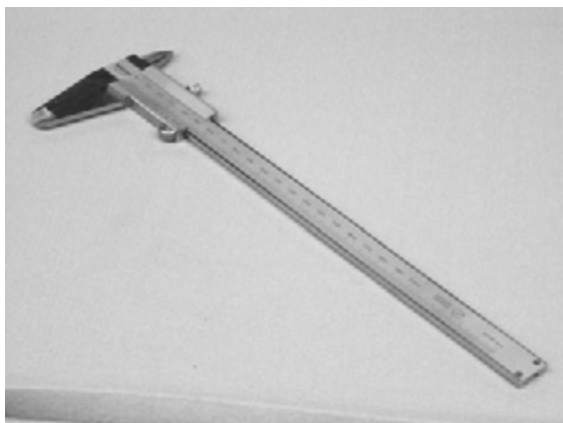

HSA90280

Tension gauge 1000cN



HSA90311

Shell alvania EP Grease 100g

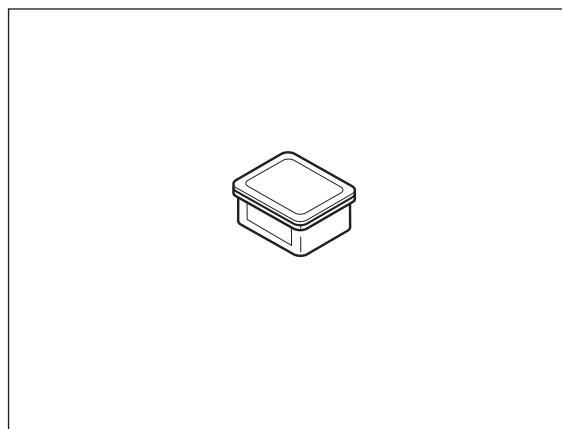

M0404342

Needle height gauge

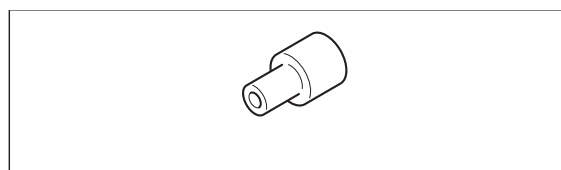

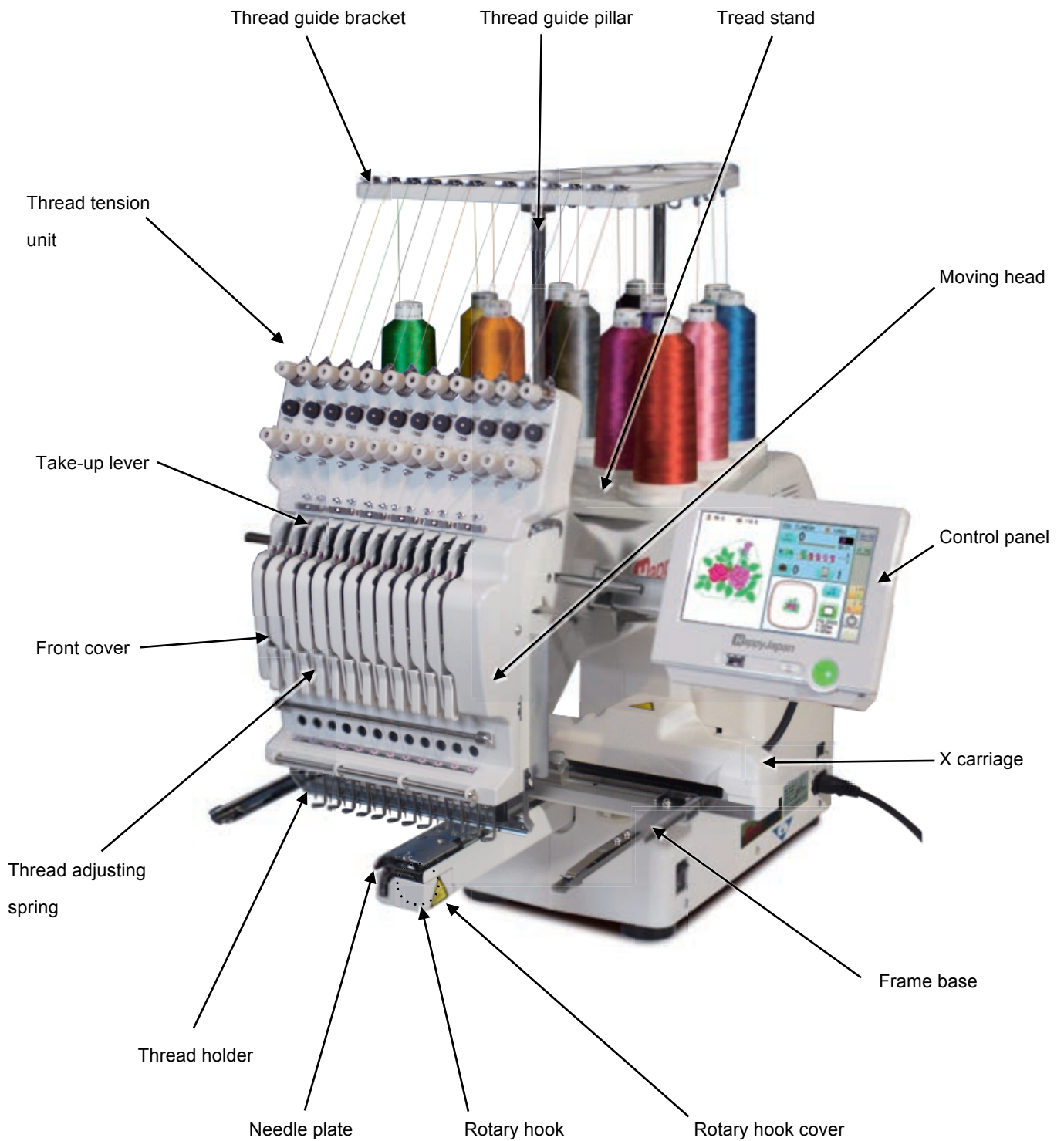

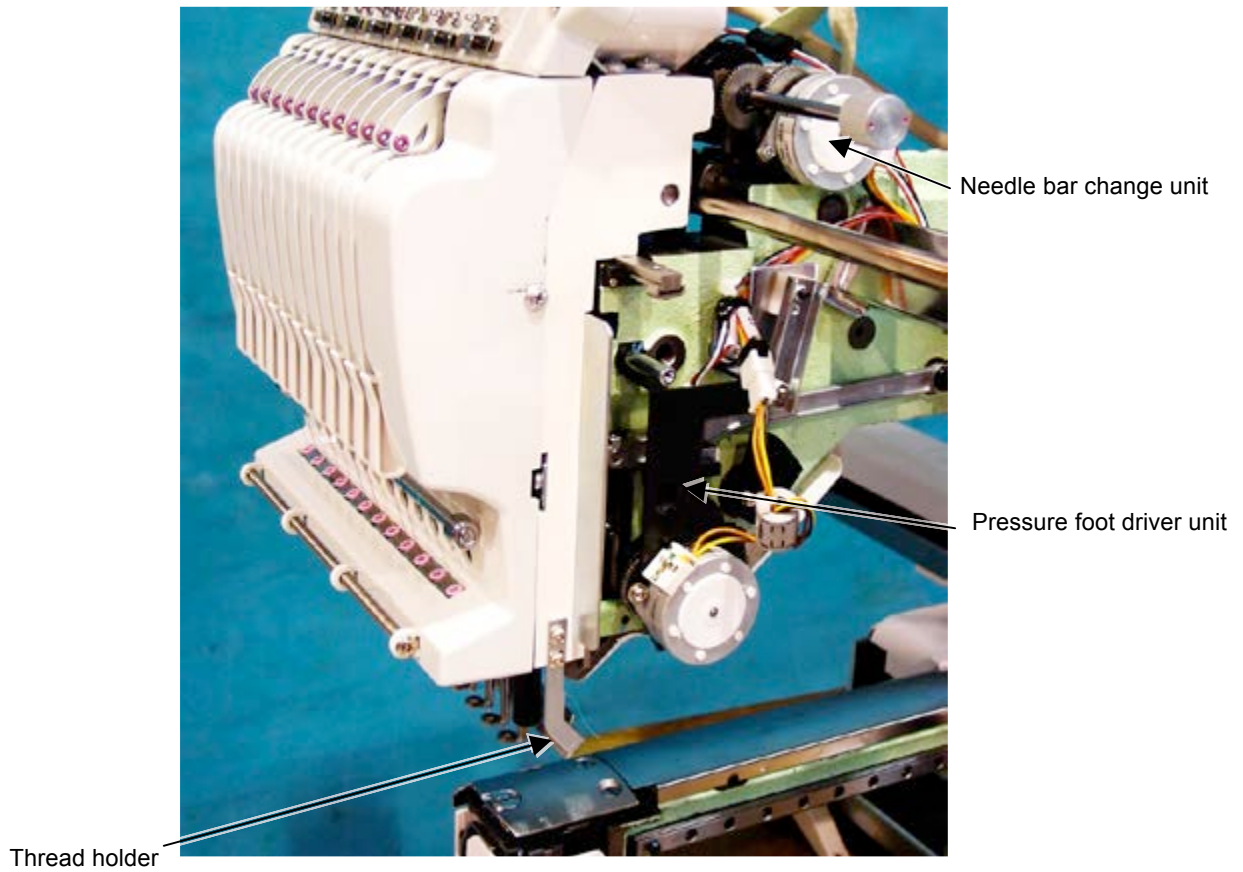
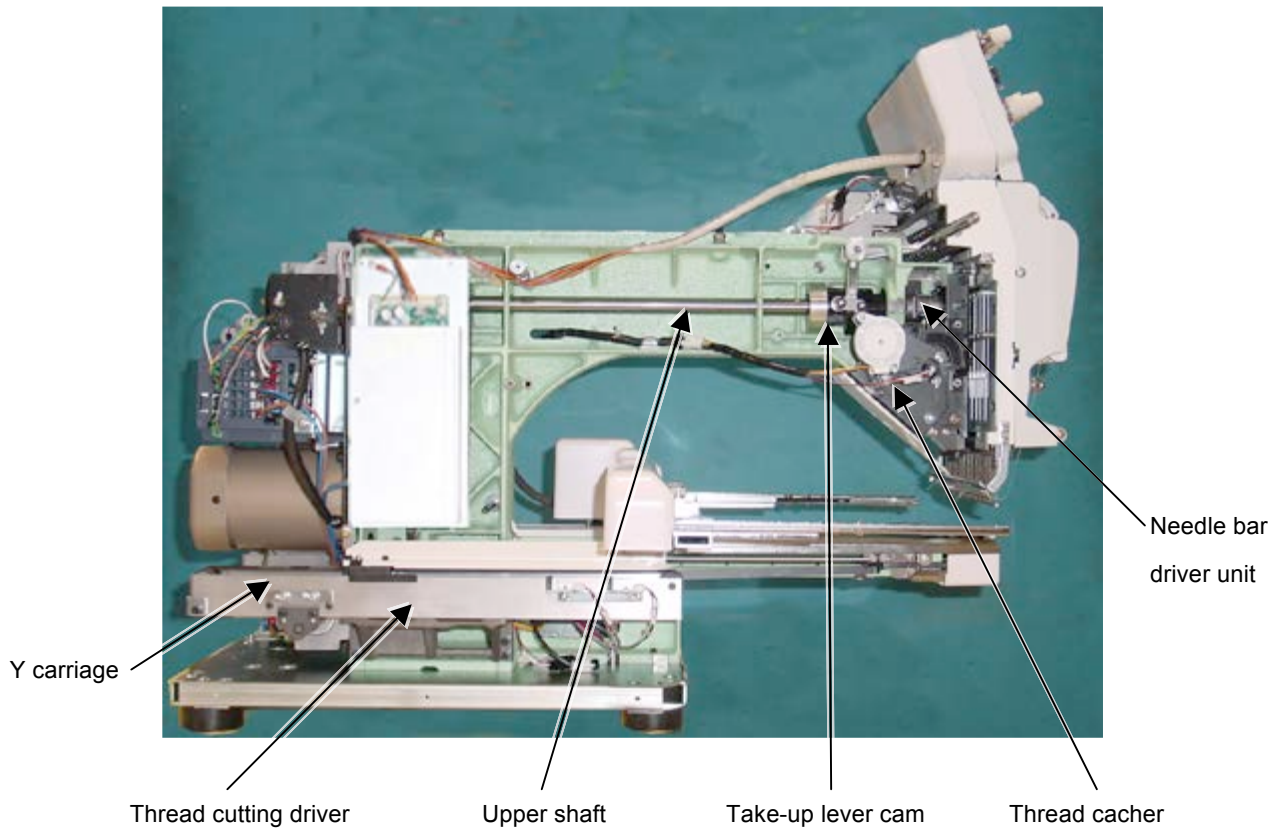

Placement of key electronic parts

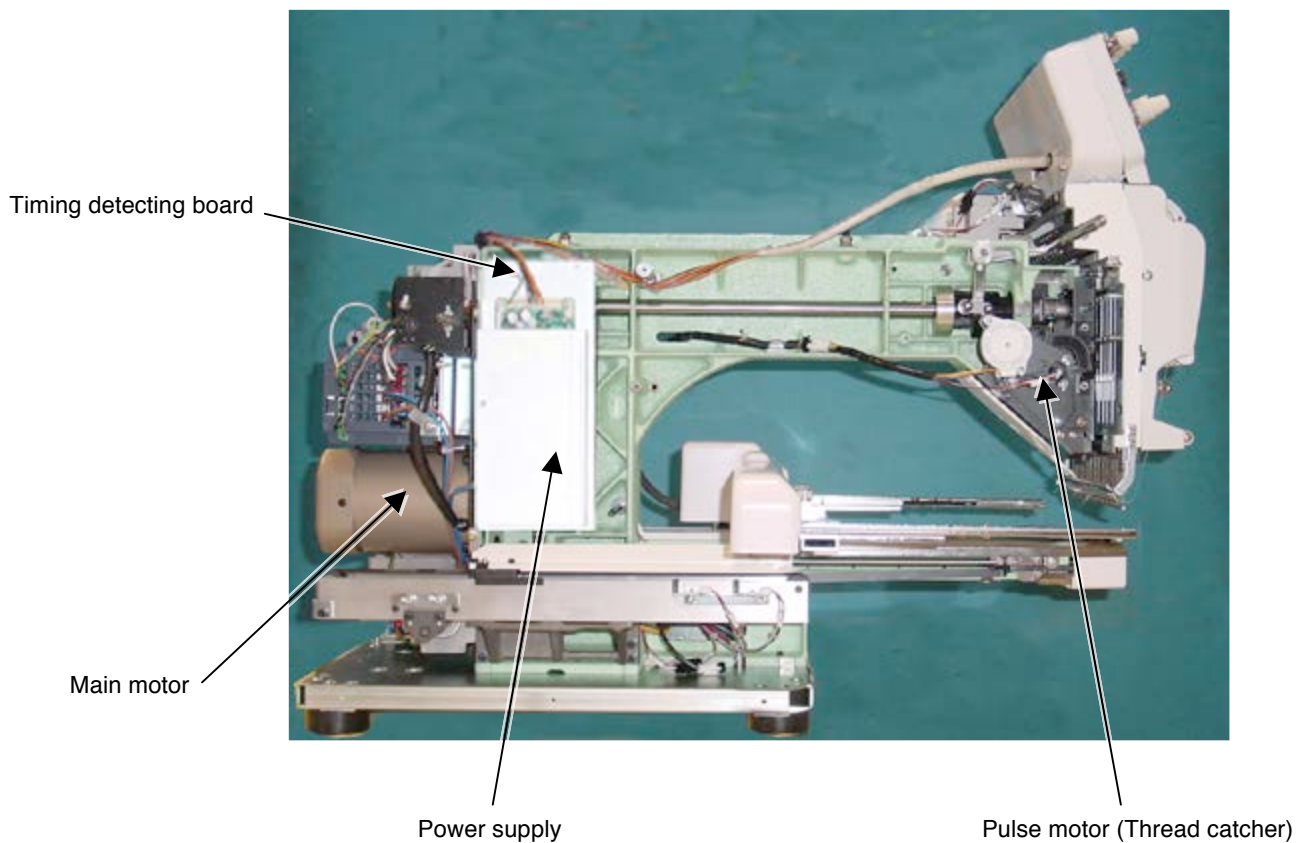
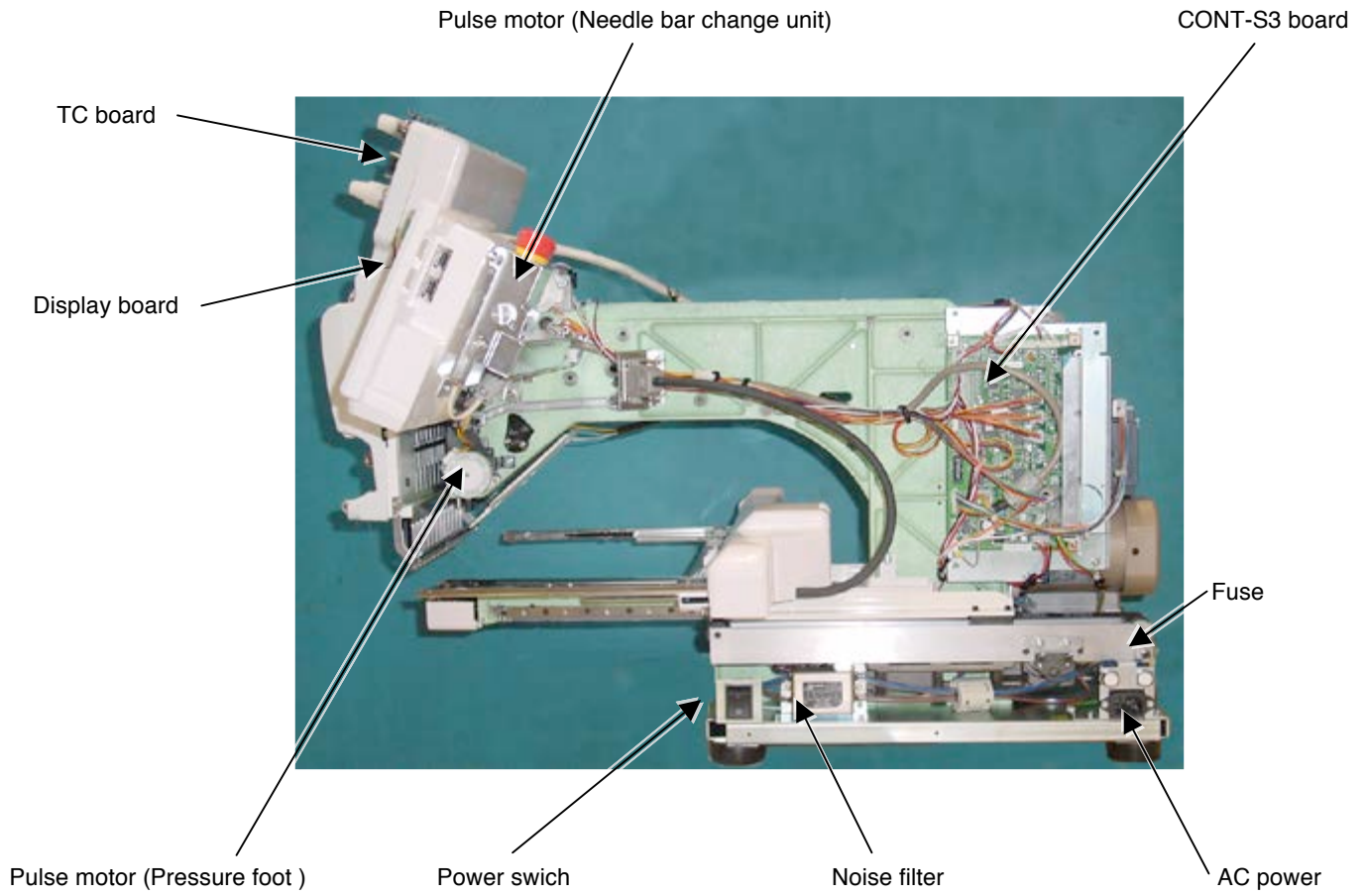

Removal of outer covers (THREAD STAND)

2-1

1. Remove thread guide bracket.

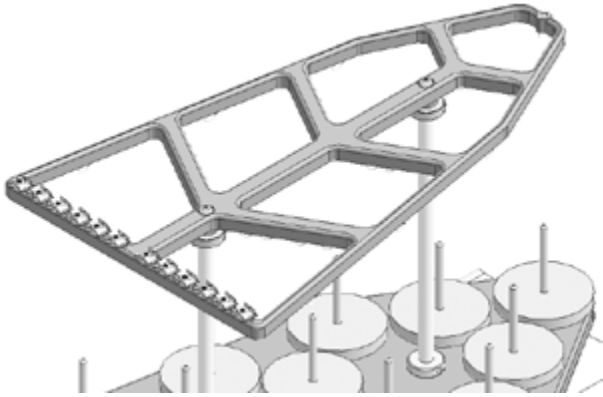

2. Loosen a screw of thread guide pillar

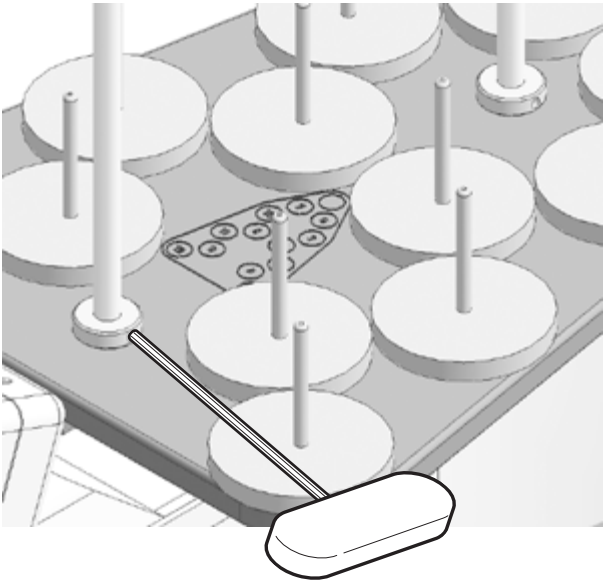

3. Remove thread guide pillar and thread stand.

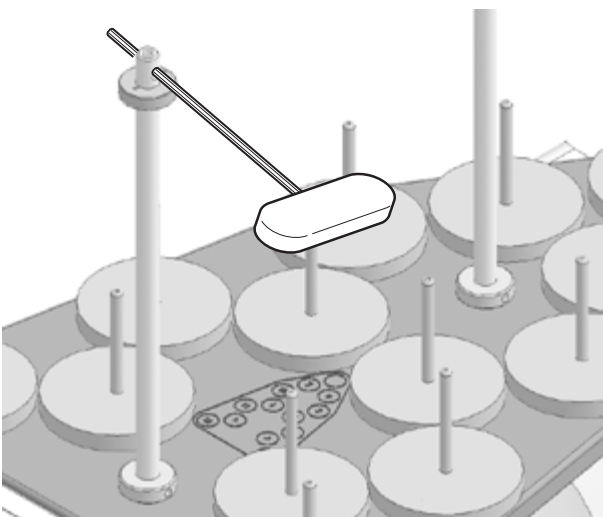

Removal of outer covers (CONTROL BOX)

<Check> Be sure to turn power switch OFF before work.

1. Remove three setscrews of arm E as shown in the figure below.

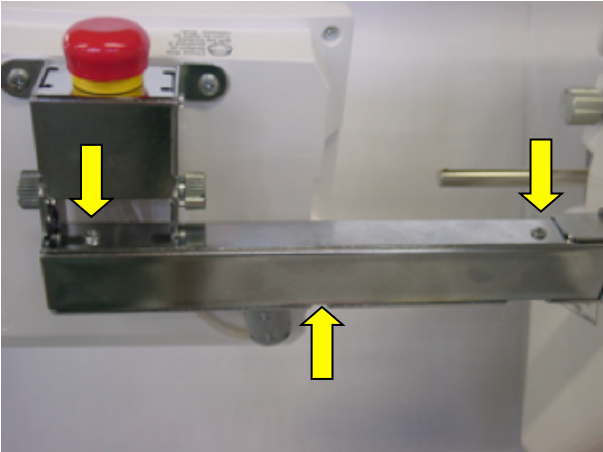

2. Disconnect the connectors indicated by the arrows in the figure below. Remove the screw that fixes cables.

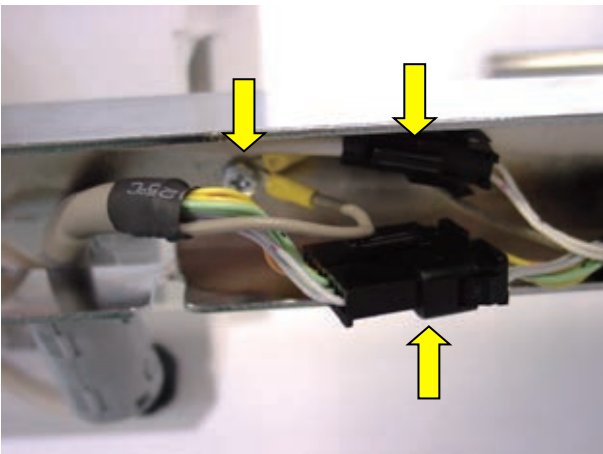

3. Remove three setscrews on arm G as shown in the figure below.

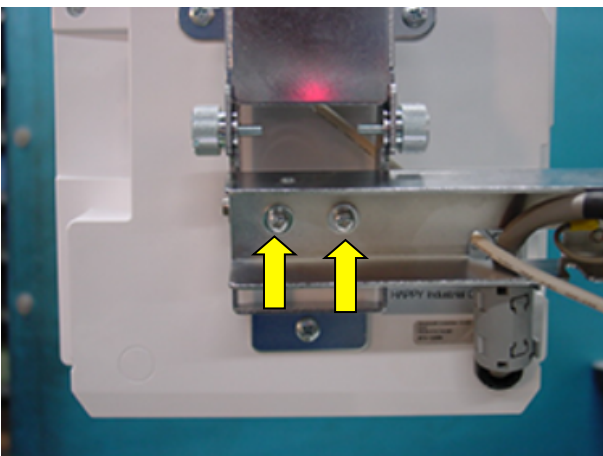

4. Remove control box.

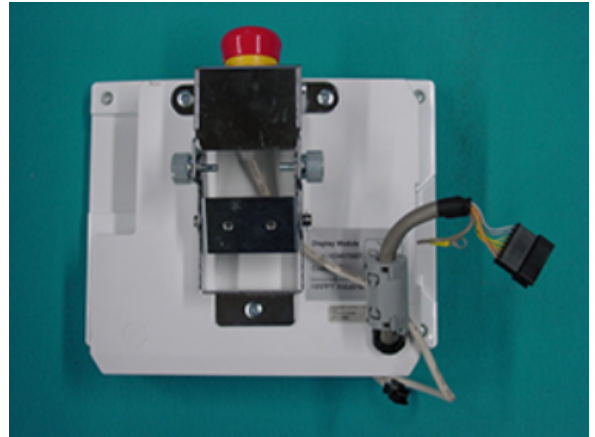

Please reverse procedure when installing control box.

Removal of outer covers

5. Disconnect cable for X carriage.



6. Remove 2 screws, then take the X carriage off.

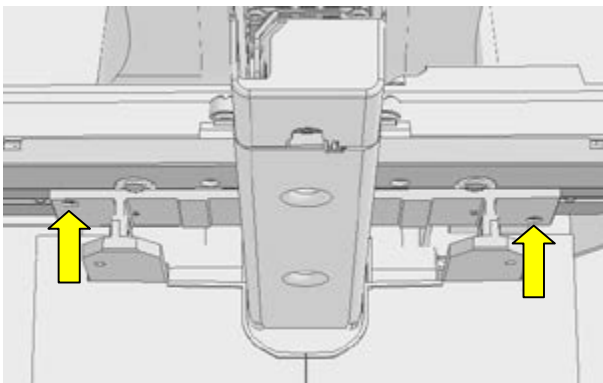

7. Remove the guide.



8. Take off rubber cap.



9. Remove cover (left). (Remove screw in arrow mark)

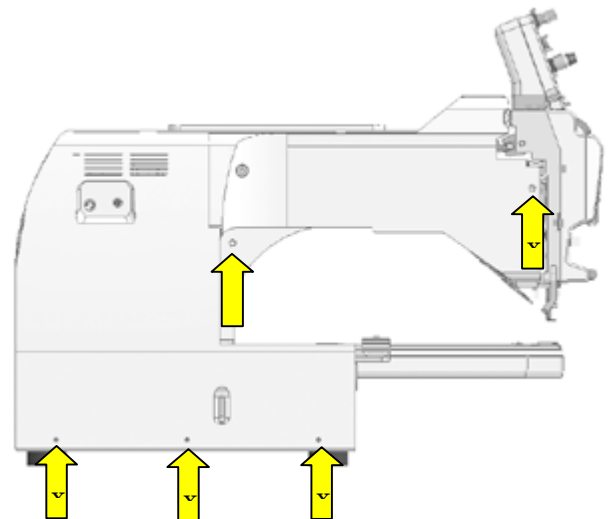

10. Unlock nail of the cover (left) by pressing an arrow point of the cover (right).



Removal of outer covers

11. Remove the cover by pressing an arrow part of the picture.

(1) Upper part of the cover

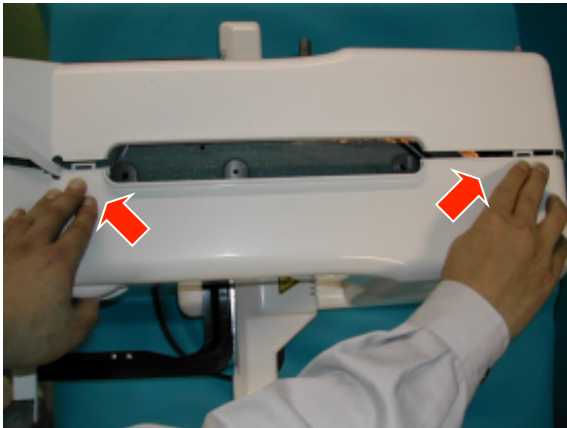

(2) Front part of the cover

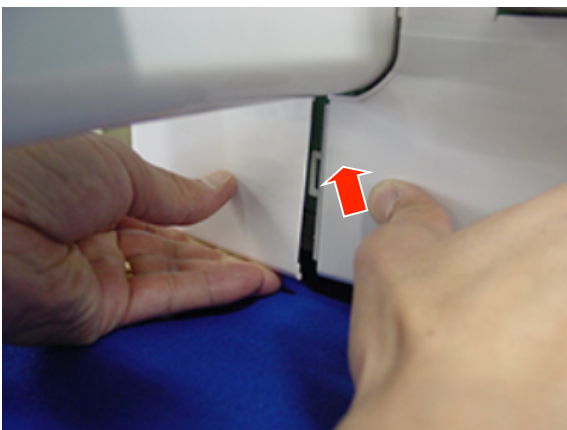

Nail shape

Male nail shape



Female nail shape



12. Remove the screw of an arrow part of the picture which fixes cover (right).

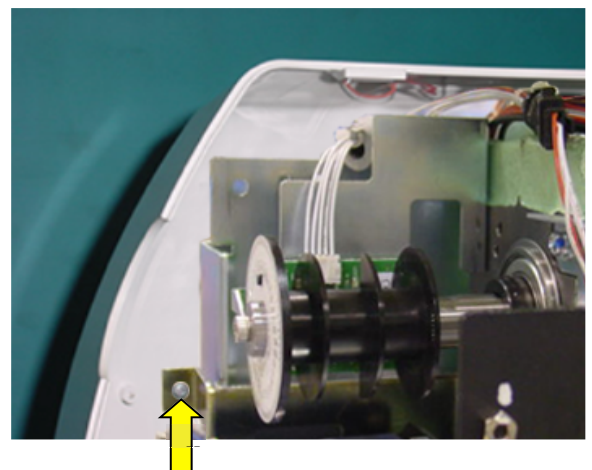
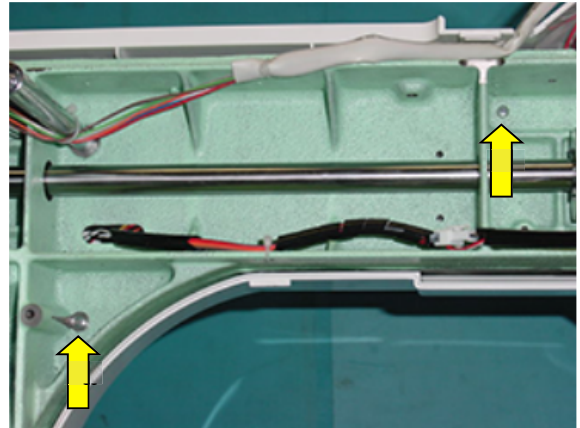

13. Remove an arrow marked screw which fixes hold arm D.

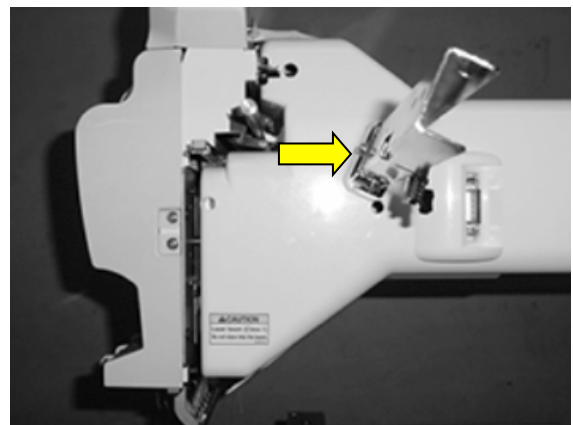

14. Remove cover (light). (Remove screw in arrow mark)

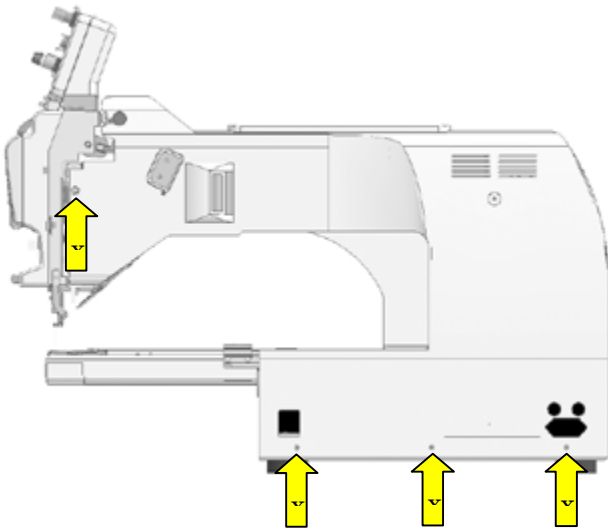

15. Remove the cover (right).

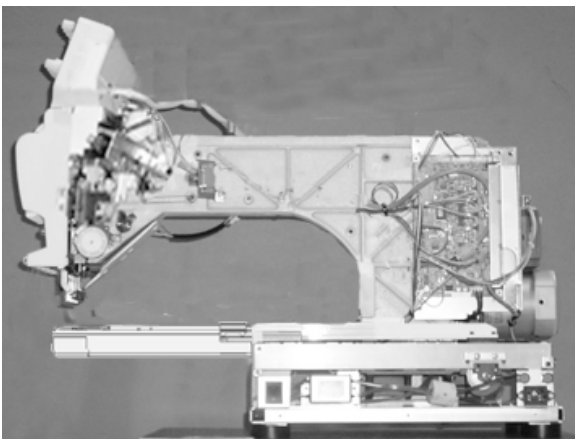

16. By above process, removal of [cover] has finished.

If you need to operate the machine with control box,
please re-assemble the arm and the control box.

Maintenance of thread path

3-1-1

In a bid to prevent poor sewing finish or thread break, please keep places where thread contacts in the best condition.

1. Thread tension, detecting roller

- a) Revolution must be smooth
- b) No sticking of lint or dust

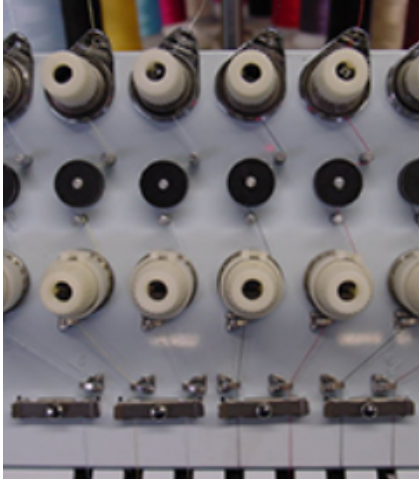

2. Ceramic and rim of take-up lever

- a) No burr and crack



3. Thread path in lower side and needle holder.

- a) No burr and crack

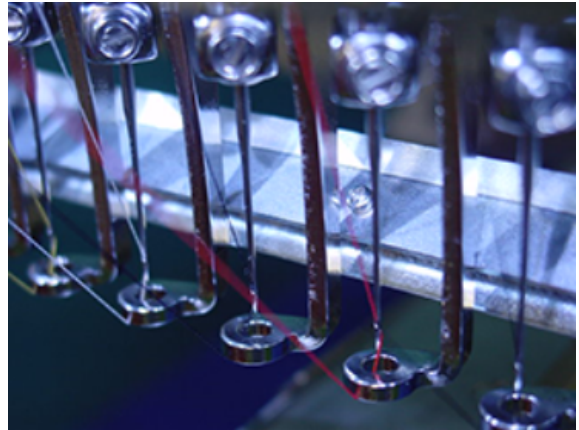
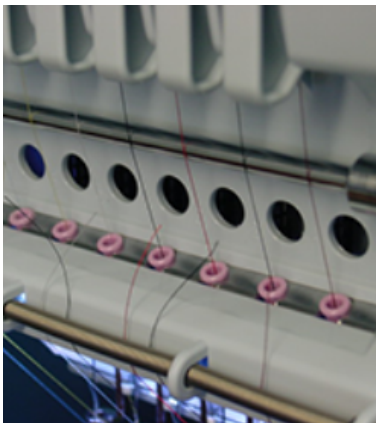

4. Needle

- a) Needle tip shouldn't be warped or bent.

When you slide needle tip on surface of nail and if the nail gets scratched.

needle tip is warped. Please exchange it with new one.



Please place needle on flat surface and check clearance (A) from side.

If clearance is not equal, needle is bent.

Please replace it with new one.

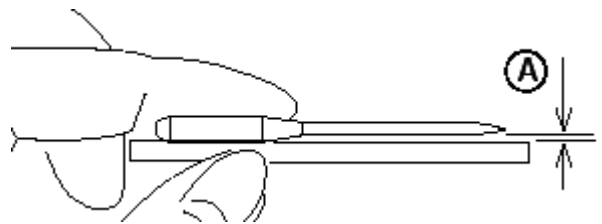

5. Needle plate

- a) No burr and crack in needle hole and around it.

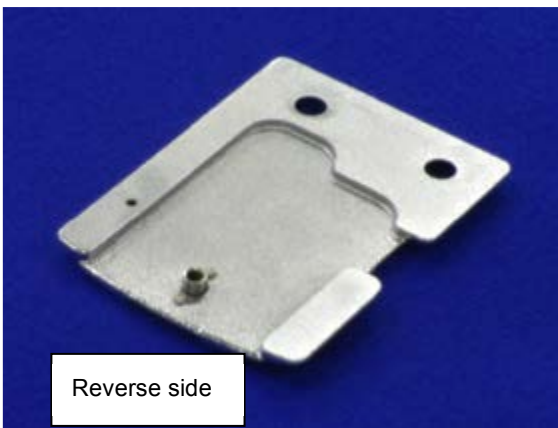
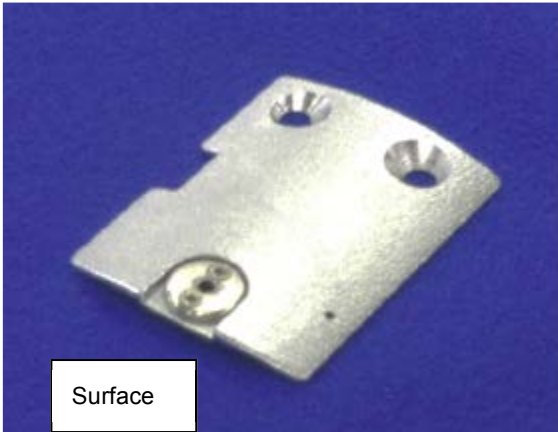

6. Pressure foot

- a) No burr and crack inside hole
- b) Not bent

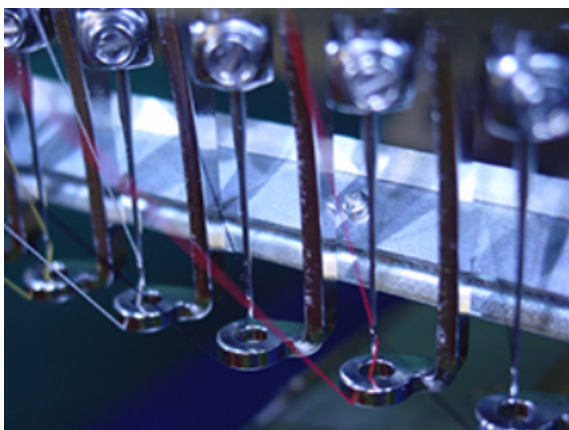

7. Rotary hook

- a) No burr and crack.
- b) Hook point not warped.
- c) Backlash between bobbin case holder and outer hook should be less.

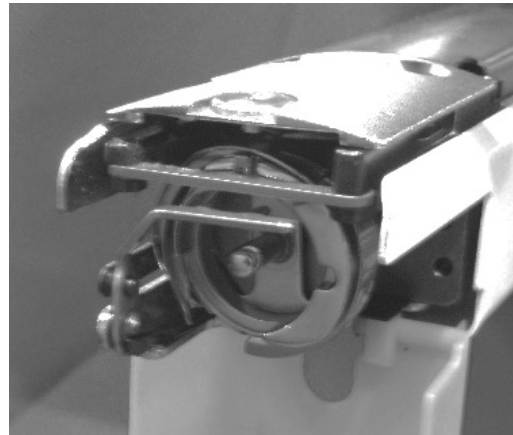

8. Keeper

- a) No burr and crack on tip.



Fixing of needle

3-1-2

1. In order of (1)-(4), please remove and fix needle.

- (1) Loosen screw holding needle.
- (2) Remove needle.
- (3) Insert needle till it goes to the end.
- (4) Tighten screw holding needle.

Fix needle so that needle groove faces front.

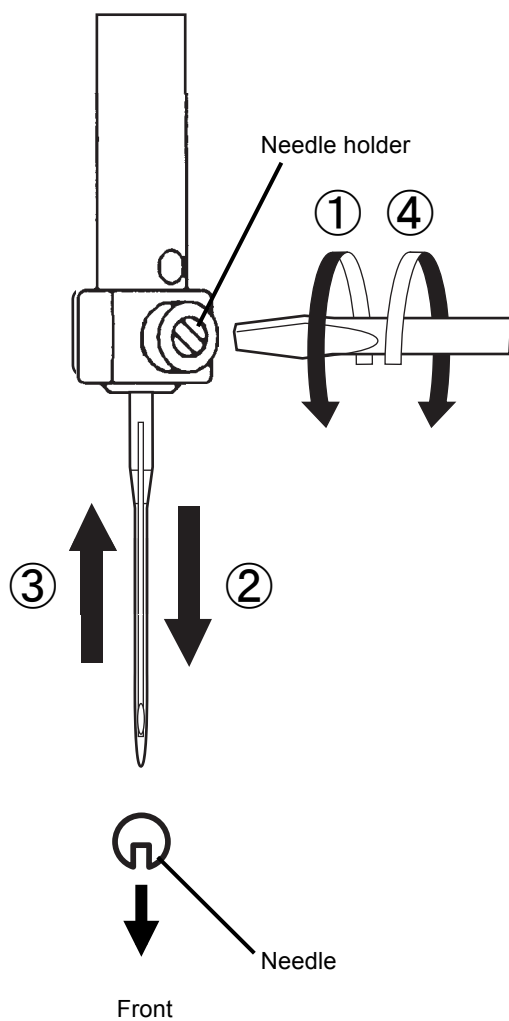

1. Selection of upper thread.

<Description>

Please select considering cloth, design of pattern and flavour etc.

<Thickness>

Please refer to [Relation between needle and upper thread 3-1-4].

<Twist>

Z twisted thread is to be used.

(As rotary hook turns left- wise, Z twisted thread can prevent loosening of twist)



Z-twisted
(Left - twisted)



S-twisted
(Right - twisted)

2. Selection of lower thread.

Basically please use cotton thread (#80-120), #120 is recommendable.

Pay attention to the following in selection.

- # Thickness should be equal.
- # When it is lightly stretched. it doesn't break easily.
- # In process of time, it doesn't get inferior.

Commercially available paper bobbin can be used, but please select thread with thickness corresponding to cotton thread (#80-120).

When you prefer to use paper bobbin, please remove spring which is located inside the bobbin case.

Relation between needle and upper thread

1. Description of needle

Basically please use [DB X K5] in standard accessory.

If description or thickness of cloth doesn't suit needle size, poor sewing finish / thread break / skipping will occur.

Therefore careful attention is required in selecting needle.

2. Relation between needle and upper thread will be found below. (Representative example is shown.)

Needle - Size is [German 75] in standard accessory.

If necessary, please select in accordance with description of thread and cloth.

Thread - In case needle size is [German 75], if thread is rayon,[#120] is recommendable.

Relation between needle and upper thread

Needle Size		Description of upper thread and thickness			
Organ	German	Cotton	Silk	Polyster	Rayon
8	60	100-130	140-160	150-200	50-70
9	65	70-80	100-120	130-150	70-100
10	70				
11	75	50-60	80-100	100-130	100-130
12	80				
13	85	36-40	60-70	80-100	130-150
14	90				
16	100	30-36	50-60	60-80	150-160
18	110	24-30	40-50	50-60	180-230

Scope to be used for general embroidery

Denier(d)

If needle size and thickness of thread don't match, following problem will be likely to occur.

- Thread break
- Skipping
- Poor sewing finish

Exchange of crank

3-2-1

1. Referring to [2-1 Removal of outer covers], remove outer covers.

2. Remove the Rear cover.

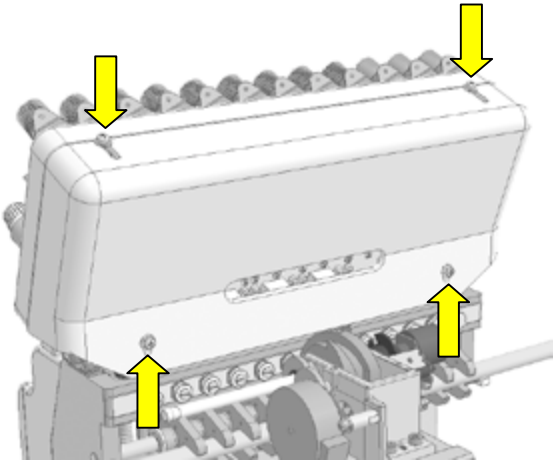

3. Disconnect TC cable, Laser pointer cable and Front lighting cable.

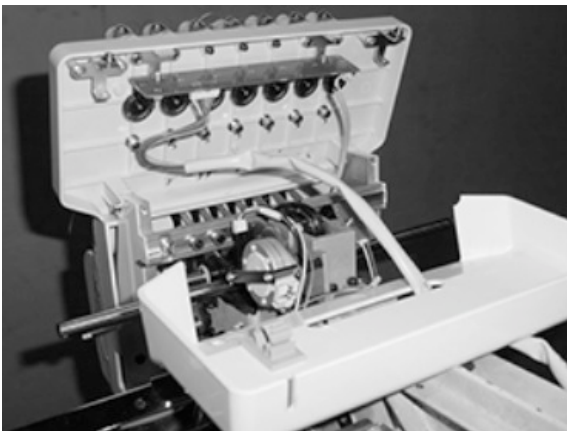

4. Remove the thread tension bracket.

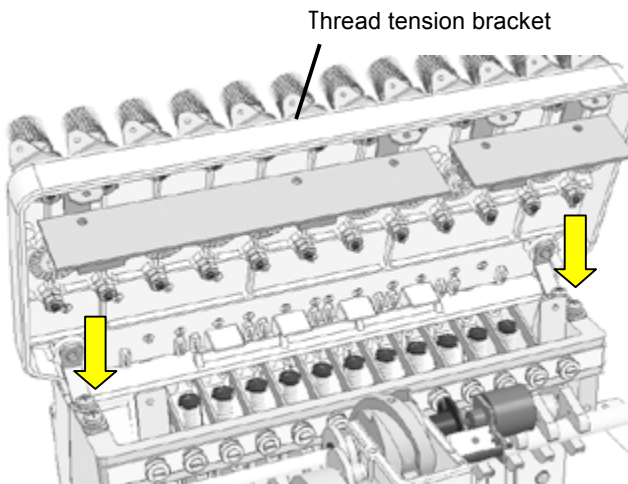

5. Loosen screws located at right and left side, then take front cover off.

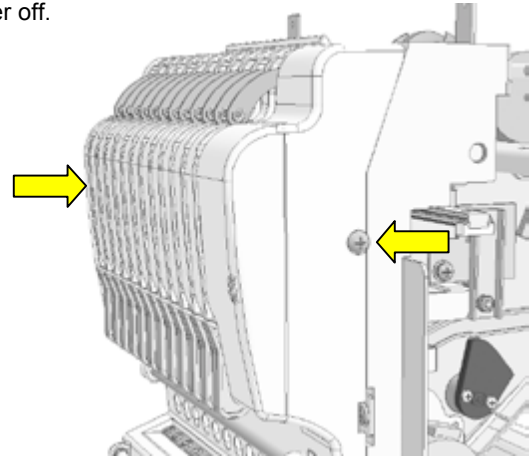

6. Change needle bar to no.1 and no.7 with turning the gear by finger and remove all arrow marked screws, then remove the moving head.

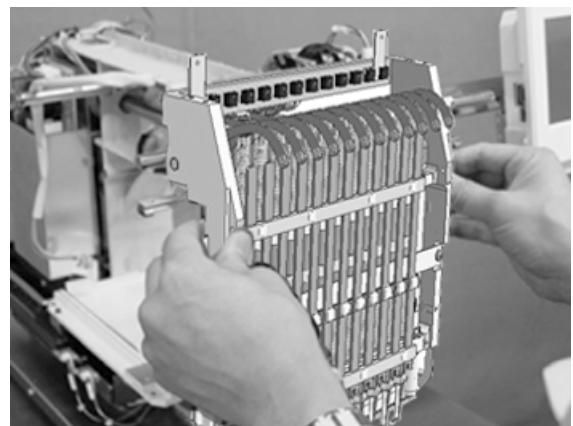
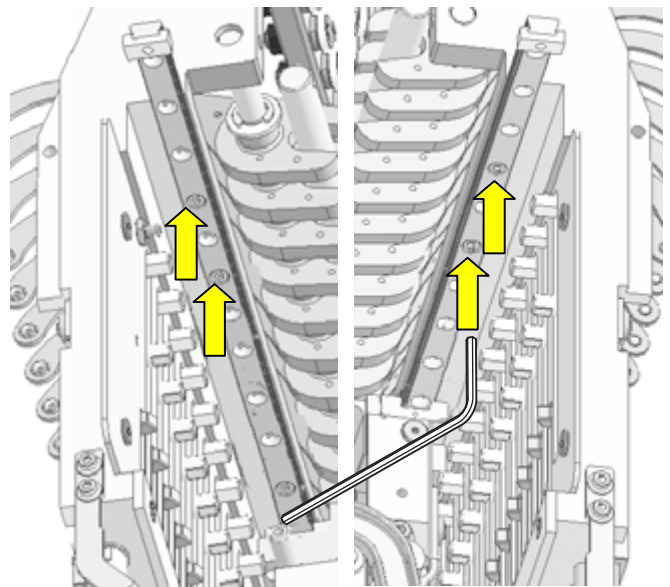

<Caution> Do not lost simm material.

Exchange of crank

3-2-1

7. Remove thread catcher ass'y

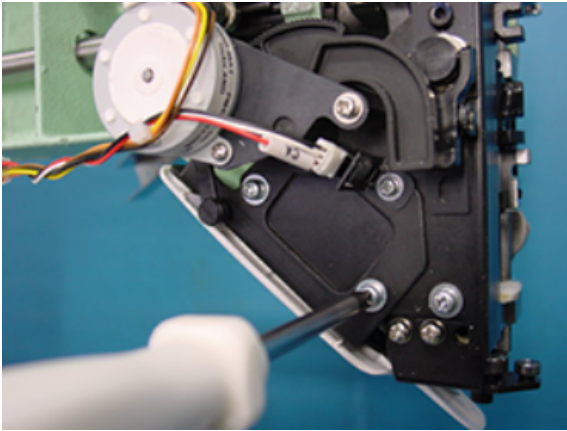

8. Remove face plate on the left.

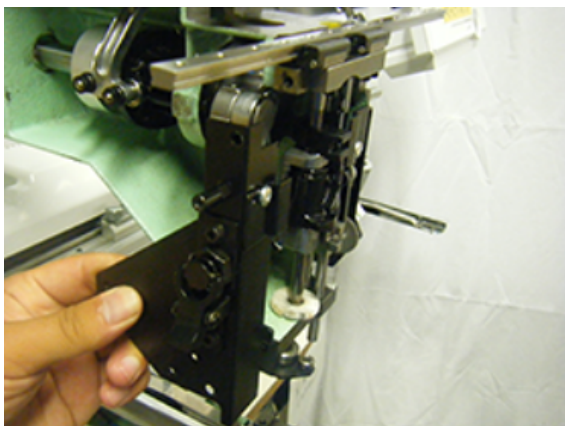
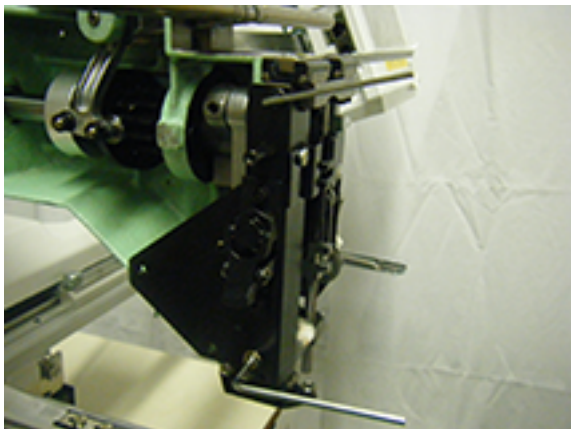

9. Referring to [3-2-4 Exchange of needle bar driver], remove needle bar driver ass'y.



10. Remove circuit board assembly for timing detecting board. Cable 1 pcs, Screw 2 pcs

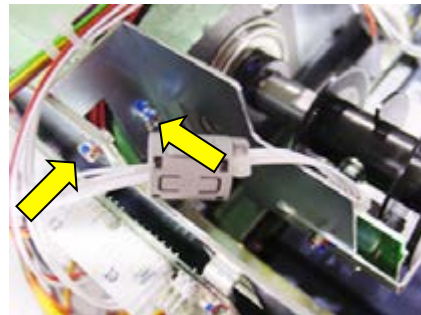

11. Remove Bobbin winder, power supply.
Screw 4 pcs

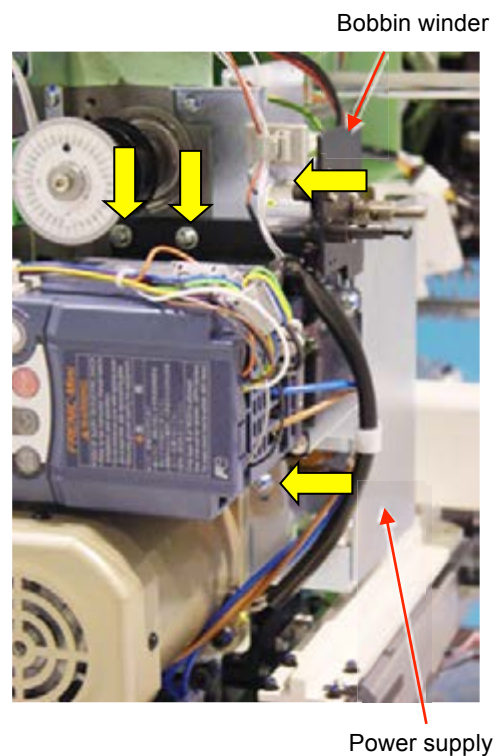

Exchange of crank

12. Loosen screw on upper shaft collar, upper pulley, drive pulley.

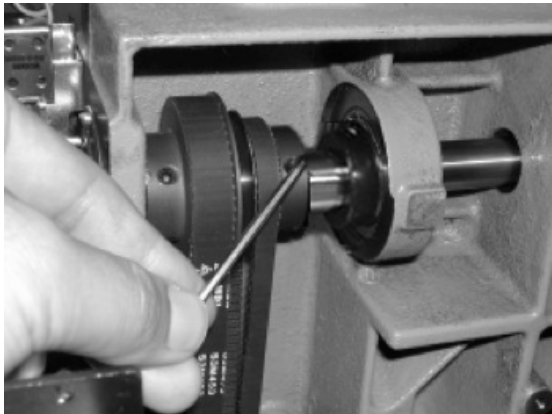

13. Loosen collar screw on take-up lever cam.

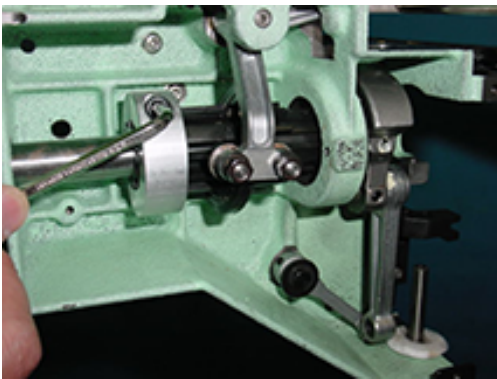

14. Loosen screw on crank.



15. Pull out upper shaft. (To the extent that crank comes out)

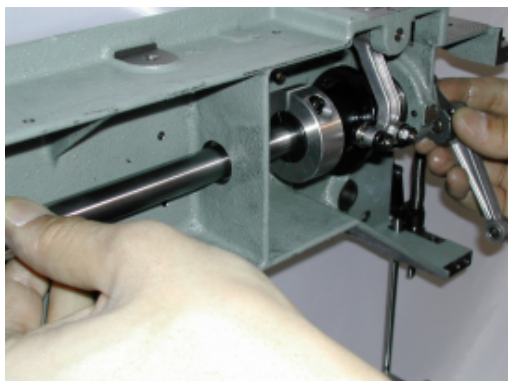

16. Remove Needle bar boss stopper.

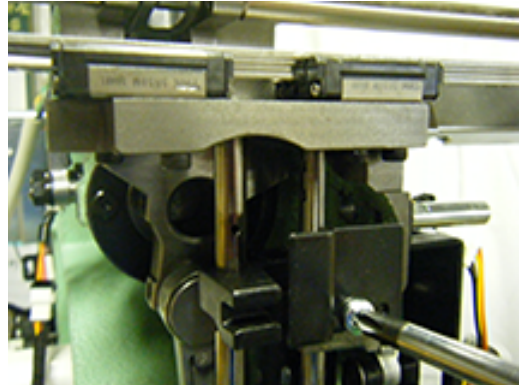

17. Loosen fixing screws and pull down pressure foot guide bar and guide shaft.

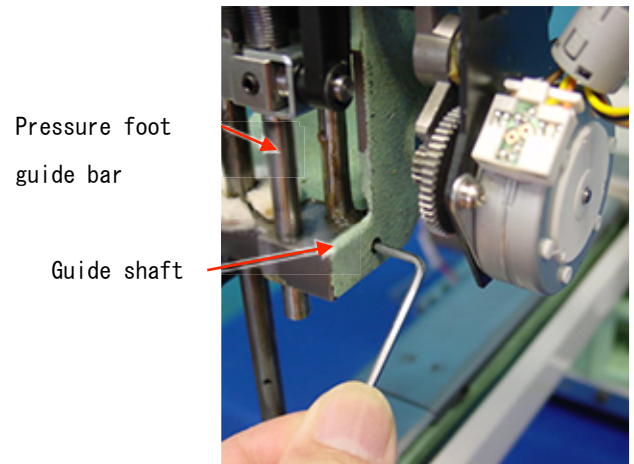

18. Remove bearing retainer.



19. Remove crank ass'y.

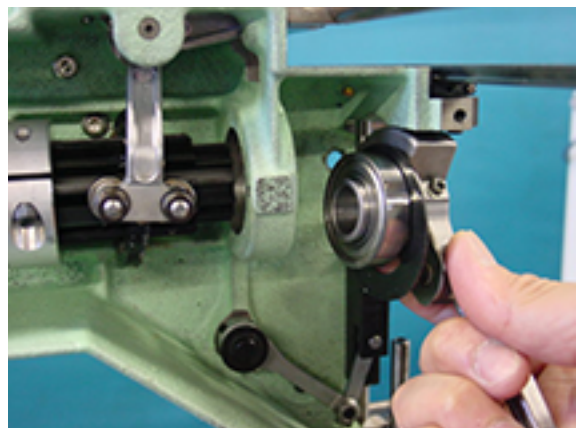

20. Put parts once removed back in reverse order

For adjusting fixing of each unit, please refer to process to adjust fixing of each unit.

<Important> Pay attention to following (1) - (4).

(1) Please fix upper shaft collar, upper pulley, drive pulley on flat surface of upper shaft with screw tightly.

(2) Make sure that pulleys and collars are attached without space from machine body except upper pulley.

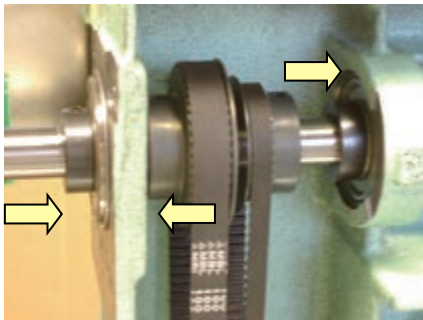

(3) Position of upper pulley is [2mm] from upper shaft collar.

(3) Position of upper pulley is space from upper shaft collar.

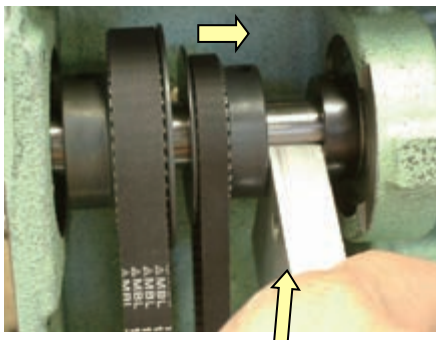

Type of small collar

Thickness gauge [11.5mm]

(4) Confirm that belt is not interfere the pulley flange and not come out from pulley groove.

Adjustment will be done with following pulley.

Timing belt has to be adjusted with upper pulley position.

Motor belt has to be adjusted with motor pulley position.

21. Please check and adjust timing mentioned below to finish.

(1) Upper shaft timing (L point, C point)

(2) Take-up lever timing

(3) Rotary hook timing

(4) Jump device

(5) Needle height

1. Referring to [3-2-1 Exchange of crank], board ass'y, face plate (left) ass'y and moving head.

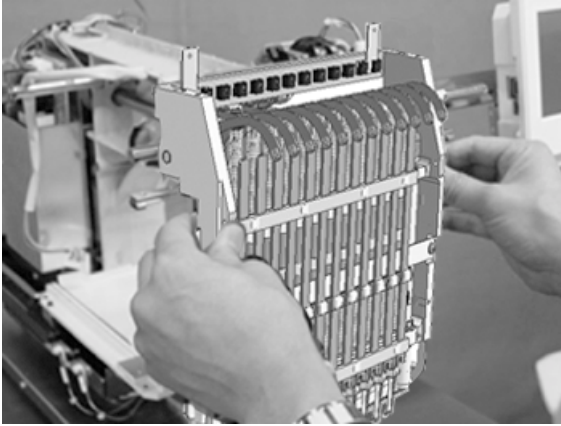

<Caution> Do not lost simm material.

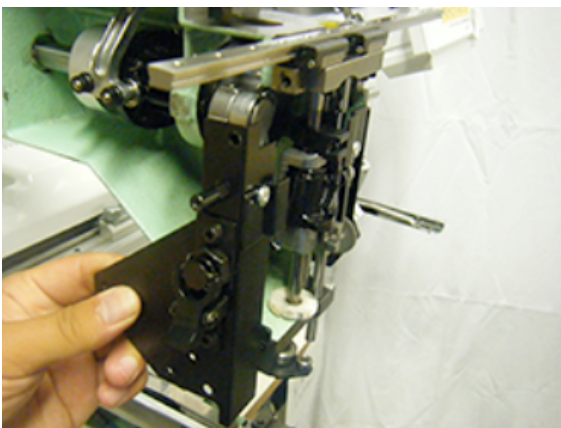
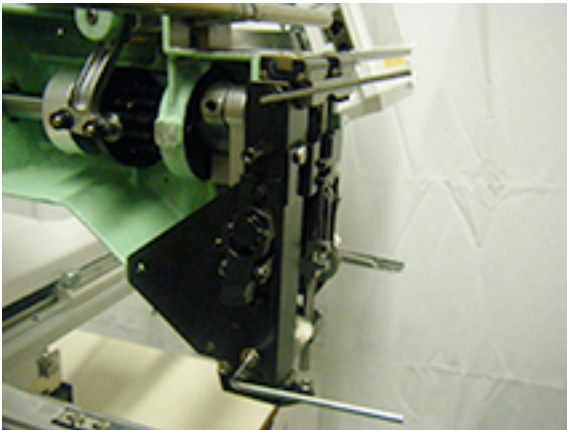

2. Referring to [3-2-4 Exchange of needle bar driver], remove needle bar driver ass'y.

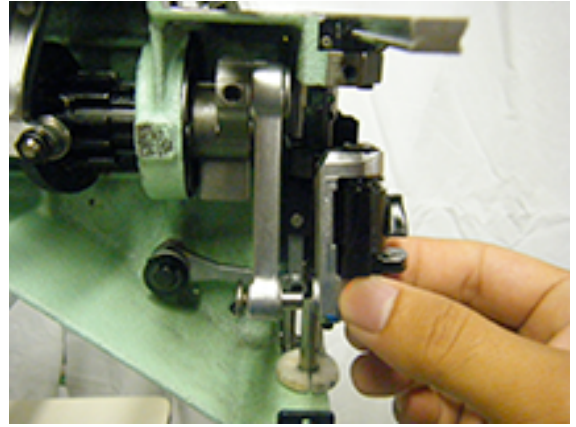

3. Loosen screw on rod pin to remove rod.

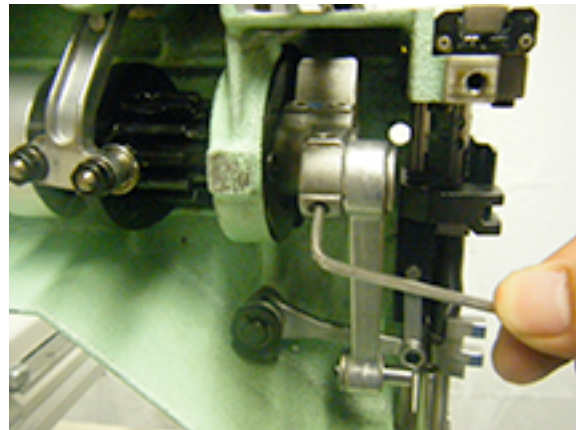

4. Install good parts.

Please confirm that the number is printed on one side of the crank and this side should be located front.

<Important> Leave space of [0.03mm] between crank and rod.

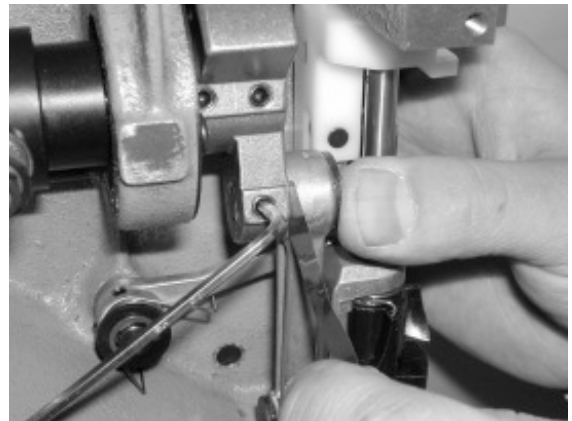

5. Put each unit back to where it was according to manual.

Adjustment of the lowest needle point

3-2-3

1. . Loosen screw on detecting disk.



2. Turn upper shaft so that needle bar driver ass'y comes in the bottom.

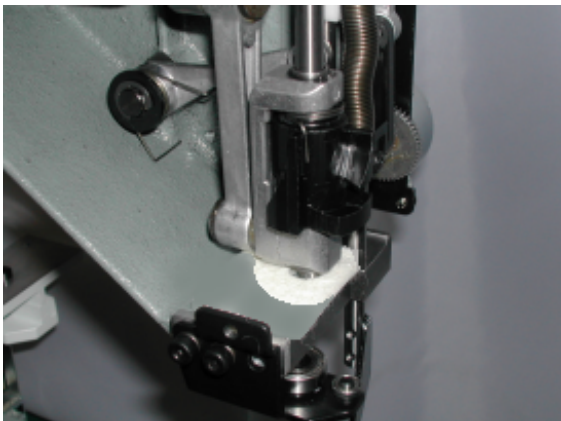

In case there is moving head, bring needle bar down.

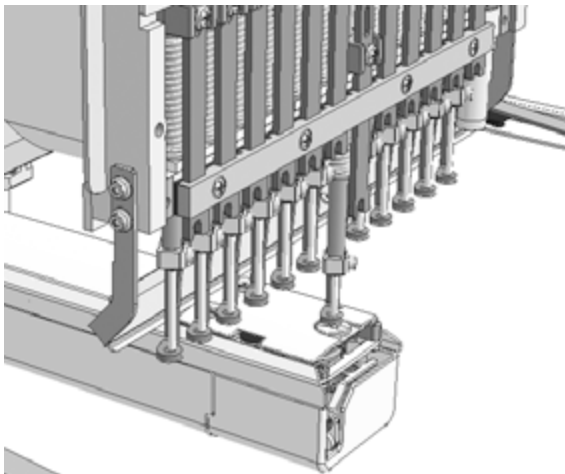

3. When dial disc reads [0 degree], fix detecting disk.

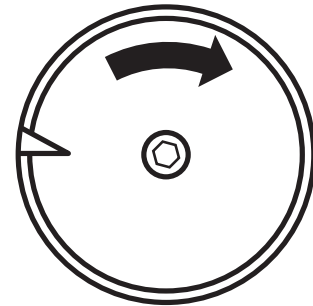

4. Work will finish by checking and adjusting timing mentioned below.

- (1) upper shaft timing (L point, C point)
- (2) Take-up lever timing
- (3) Shuttle hook timing
- (4) Jump device
- (5) Needle height

Please use dial gauge for strict checking.

Please see that timing on dial disc comes to [0 degree] when dial swings in highest value.

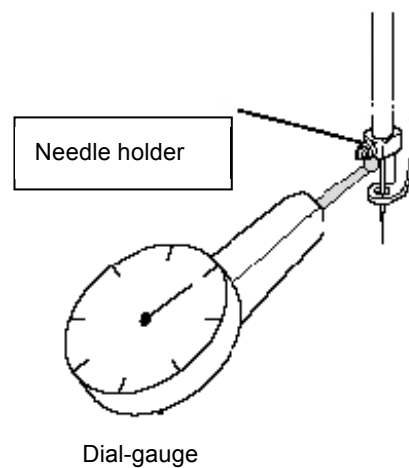

Exchange of needle bar driver

3-2-4

1. Referring to [3-2-1 Exchange of crank],
Remove board ass'y, face plate (left) ass'y and moving head.

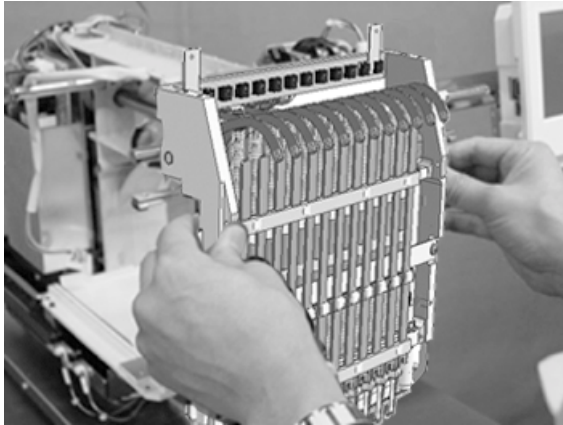

<Caution> Do not lost simm material.

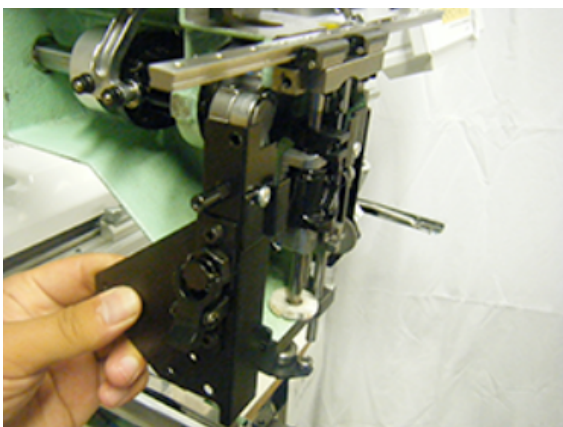
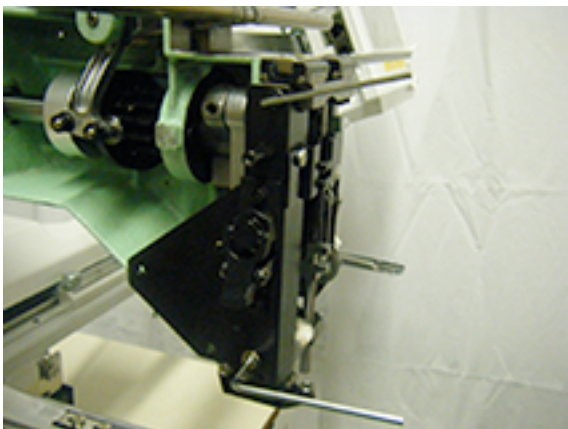

2. Loosen screw on main shaft in head.



3. Pull out main shaft in head.



4. Loosen screw on lower part of needle bar driver ass'y.

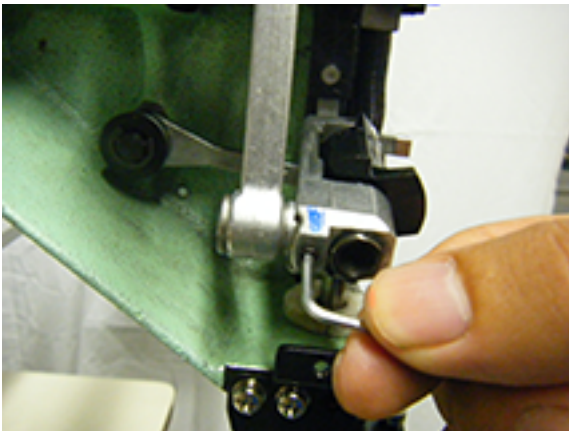

5. Remove needle bar driver ass'y.



6. Install good parts.

<Important>

Make sure that Needle bar driver ass'y rotate smoothly and no clearance between rod and arm.

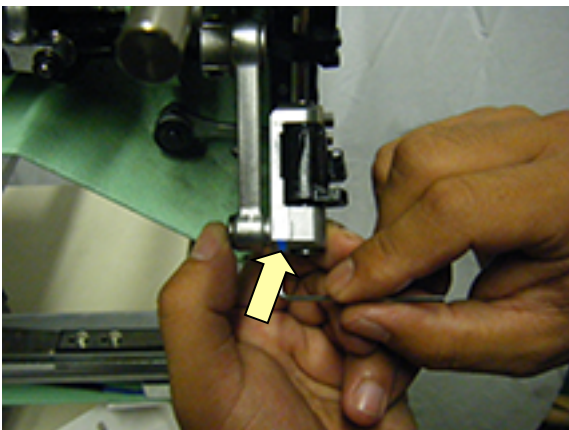

7. Put each unit back according to manual.

8. After exchange, please be sure to adjust needle height.
Please refer to [3-3-6 Adjustment of needle height].

<Attention>

Head shaft should be positioned slightly lower than ditch for oil.

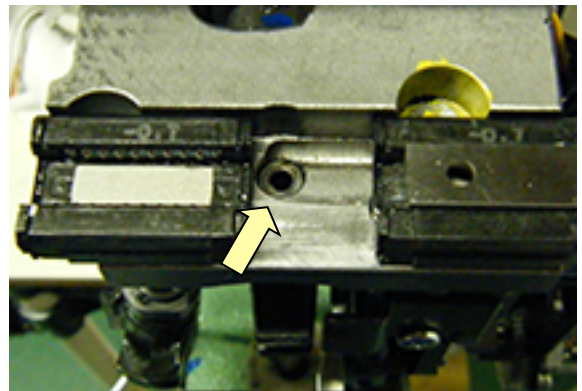

Adjustment of fixing of jump device

1. Referring to [3-2-1 Exchange of crank],
Remove moving head.

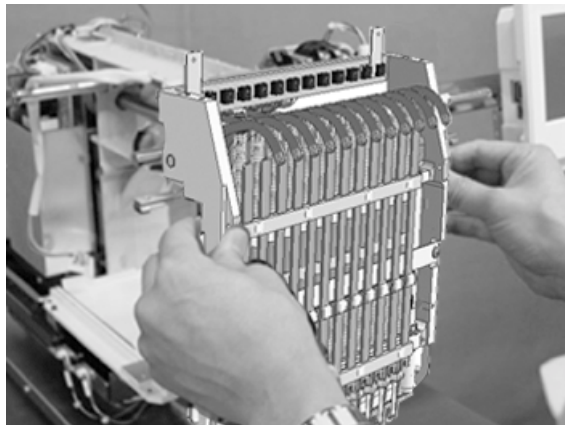

<Caution> Do not lost simm material.

2. Move the rod of thre dcat cher nd Remove jump device.

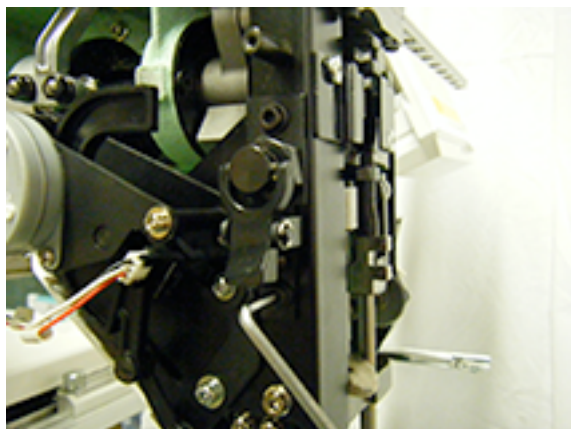

3. Install good parts.

4. Install good parts.

Set upper shaft to [80 degrees] to adjust position of Jump shaft of jump device and Needle bar driver as illustrated below.



<Front view>

Viewing from front, Needle bar driver should come to center of Plunger.

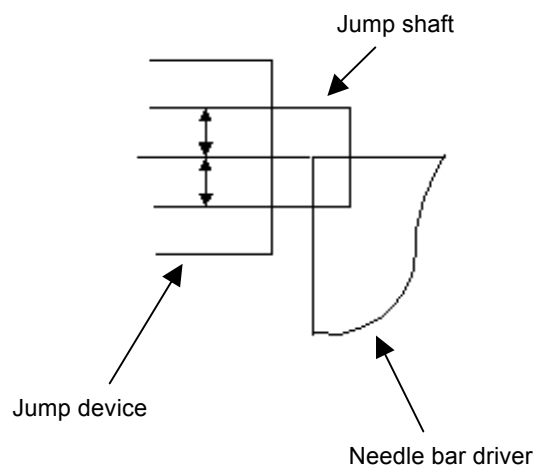

<View from left>

This shows a state that plunger and Needle bar driver contacts.

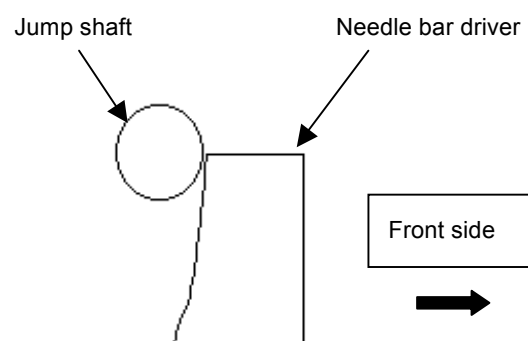

5. Set upper shaft to [180 degrees] and confirm that the tip of the body is located at right side of the Head shaft center line.

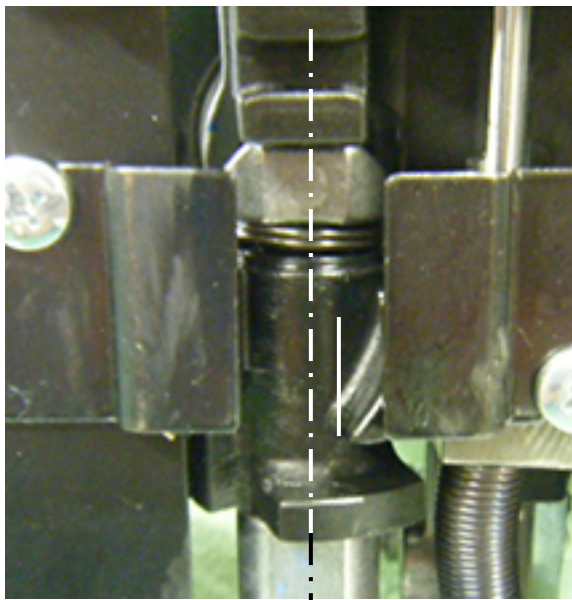

6. Please put parts back in reverse order to finish.
For adjustment of fixing of each unit, please refer to process to adjust fixing of each unit.

Exchange of take-up lever cam

3-2-6

1. Referring to [3-2-1 Exchange of crank], pull out upper shaft

2. Remove take up lever cam.



3. Remove fasten collar.

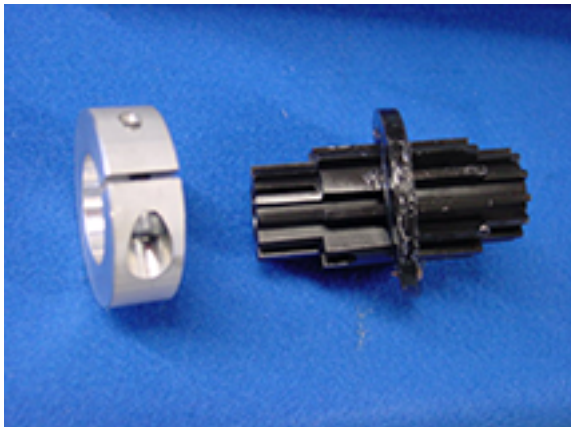

4. Put good parts back in reverse order.

For adjustment of fixing of each unit, please refer to process to adjust fixing of each unit.

<Important> Pay attention to following (1) - (5)

(1) Please fix upper pulley, crank ass'y on flat surface of upper shaft with screw tightly.

(2) Make sure that pulleys and collars are attached without space from machine body except upper pulley.

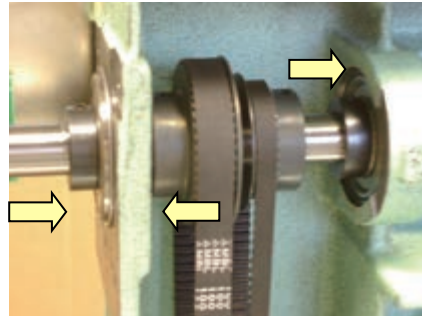

(3) Position of upper pulley is space from upper shaft collar.

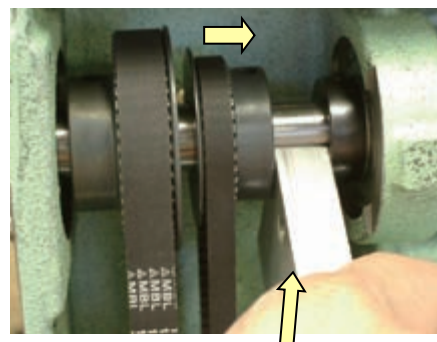

Type of small collar

Thickness gauge [1.5mm]

(4) Confirm that belt is not interfere the pulley flange and not come out from pulley groove.

Adjustment will be done with following pulley.

Timing belt has to be adjusted with upper pulley position.

Motor belt has to be adjusted with motor pulley position.

(5) Please insert the Barrel cam into the Fasten collar first, then assemble it to the Upper shaft.

5. Please check and adjust the following timing to finish.

(1) lowest needle point

(2) upper shaft timing (L point, C point)

(3) Take-up lever timing

(4) Shuttle hook timing

(5) Jump device

(6) Needle height (7) pressure foot

Exchange of roller shaft ass'y

1. Remove take-up lever crank.

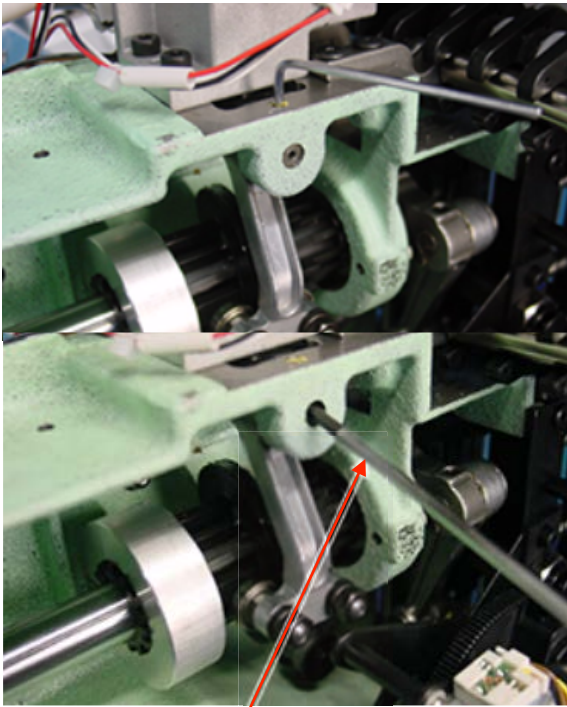

Push take-up lever shaft by slender shaft.
(Hexagon wrench etc.)

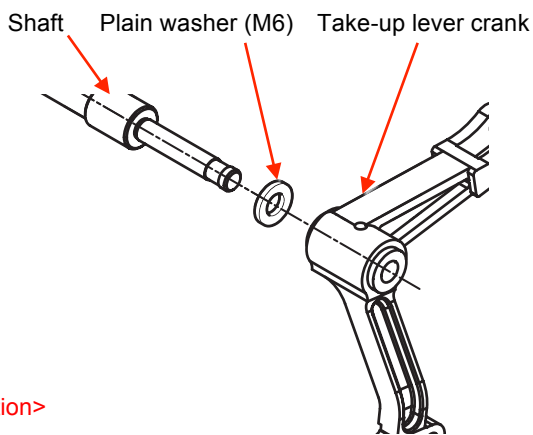

<Attention>

Machine number ~1047001 is having a Plain washer (M6) between Shaft and Take-up lever crank.

2. Exchange roller shaft ass'y.

<Spanner> 7mm, 8mm



3. Insert bering positioning gauge [4.85mm] between bering and bering , and then tighten roller shaft ass'y.

Please adjust roller shaft for machine front side ways.

This roller shaft ass'y is eccentricity.

Turn lean screw and just touch roller to gauge.

Bering positioning gauge [4.85mm]

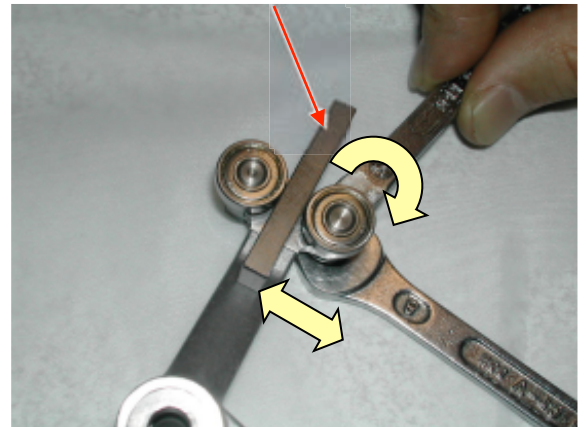

4. Return take-up lever crank ass'y to previous place to finish.

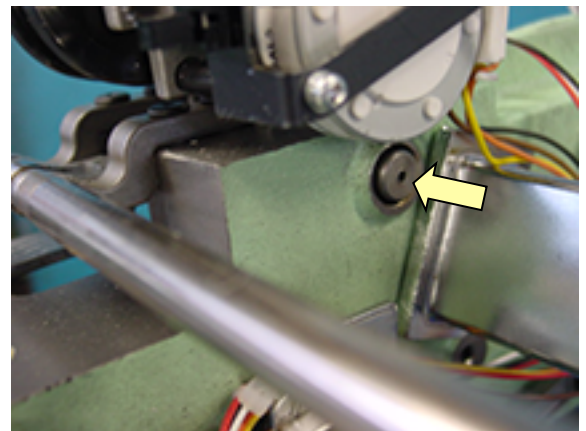

Please push to arrow ways until stop.

<Attention>

Although the Take-up lever crank is assembled to the left side, but it is correct.

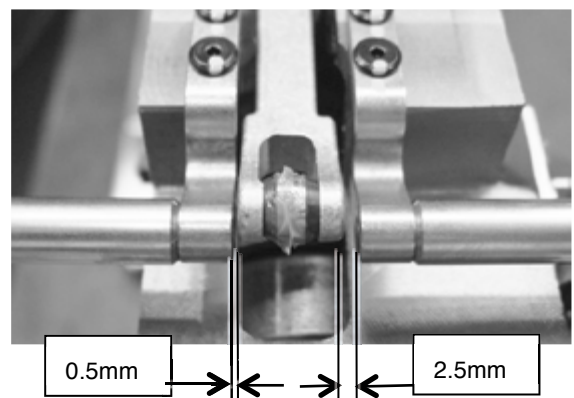

Adjustment of take-up lever timing

3-2-8

1. . Loosen screw on fasten collar for take-up lever cam.

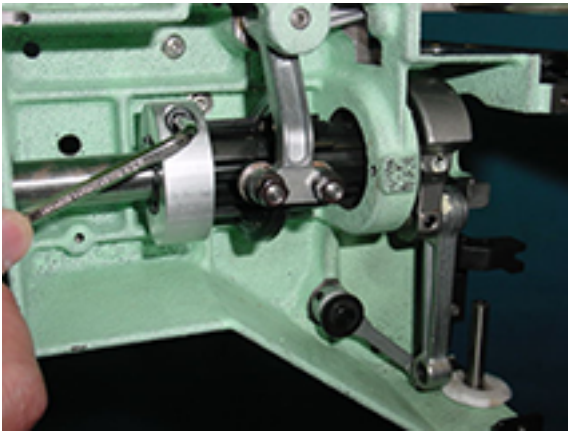

2. Set dial disc to [10 degrees].

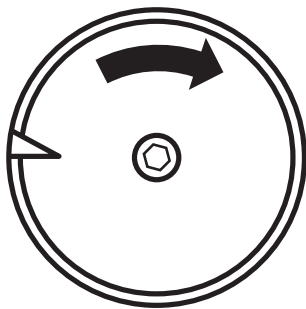

3. Insert positioning pin from right side.

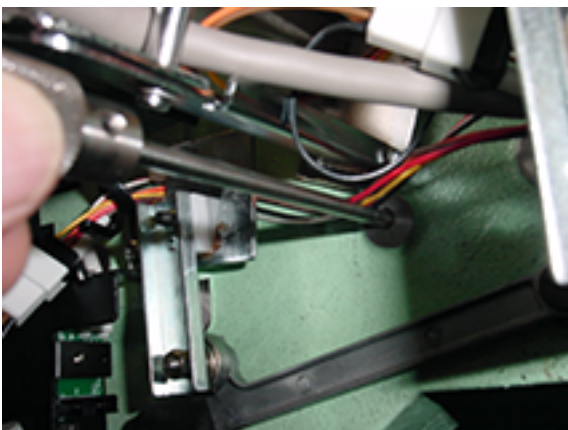

4. Turn take up lever cam slowly and insert positioning pin into pin groove.

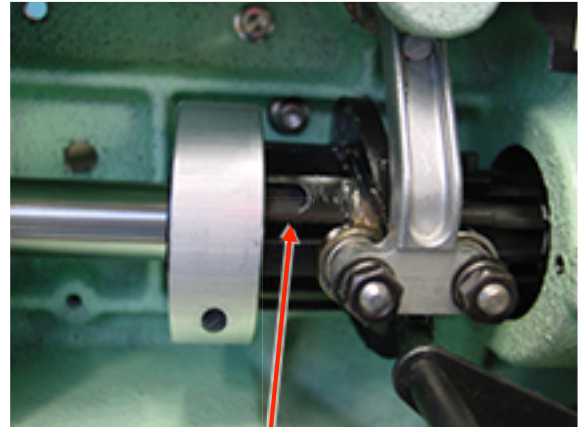

pin groove

5. Loosen screw.

<Important>

Rotate the Take up lever cam clockwise until pin ditch touches to positioning pin then tighten the screw.
(No gap between take-up lever cam and crank)

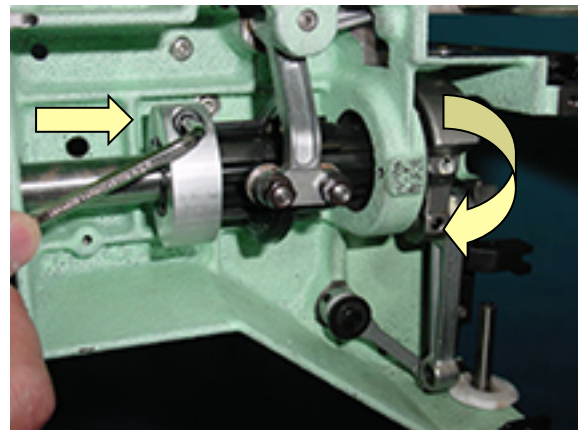

6. Pull out positioning pin.

7. Turn upper shaft and set dial disc to [C] to finish.

Exchange of pressure foot cam

3-2-9

1. Remove screw on pressure foot cam.

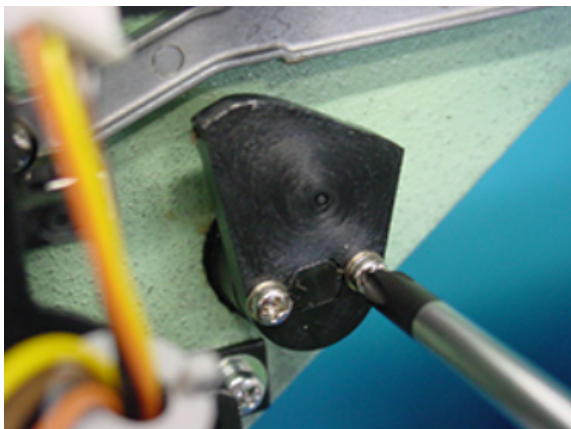

2. Exchange pressure foot cam.



3. Put on grease to pressure foot cam.

<Grease>

Shell alvania EP Grease2

(Shell Gudas S2 V220 2)

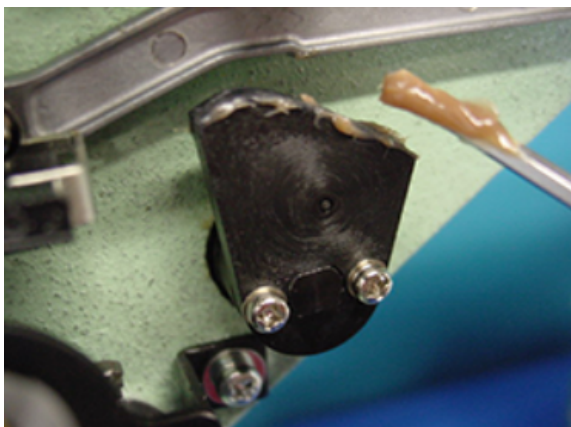

4. Exchange has finished.

Check of height of pressure foot

1. Bring pressure foot down. (Either way mentioned below)

(1)press  **P_FOOT** key on control box.

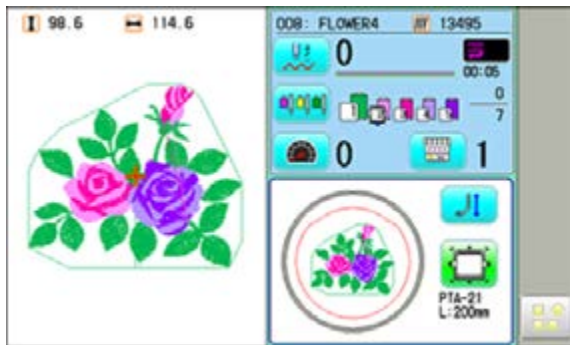

(2)Turn gear with finger.

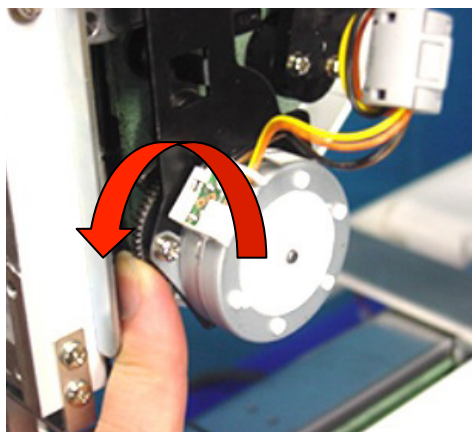

2. Bring needle bar down by finger.

Also you can move down the needle bar by maintenance mode through menu of control box.

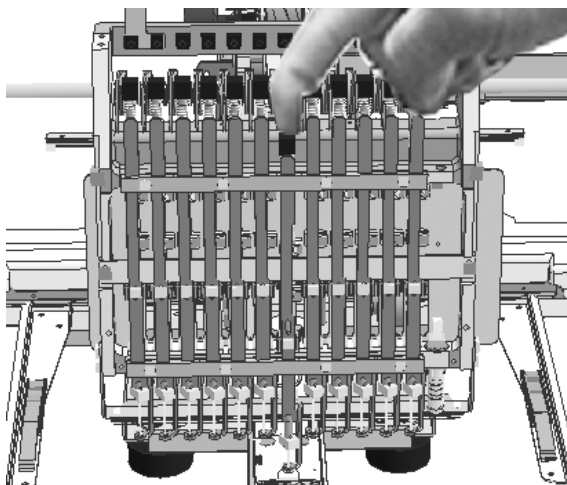

3. Turn upper shaft and set dial disc to [0 degree].

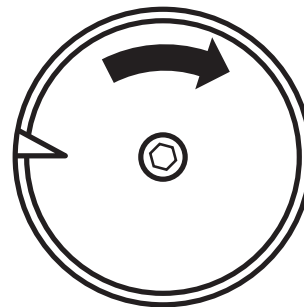

4. Insert [Gauge 1.2mm] between needle plate and pressure foot.

No gap between gauge and pressure foot or needle plate, will be OK.

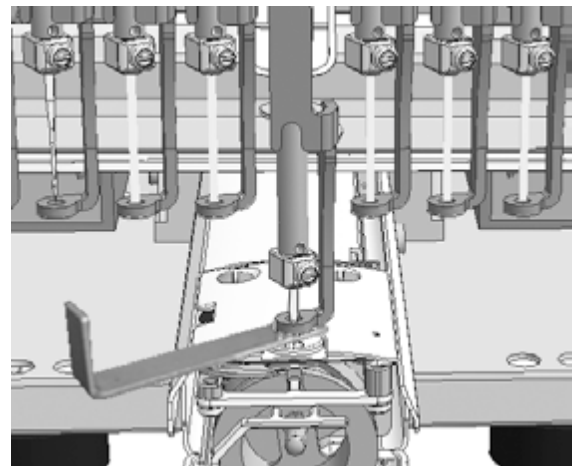

In case the space is not 1.2mm, loosen the fixing screw and adjust height of pressure foot as following picture.



After adjustment, when pressing pressure foot to bottom with hand, confirm whether pressure foot turns back by spring.

1. Referring to [3-2-1 Exchange of crank], remove Front cover and Thread tension.

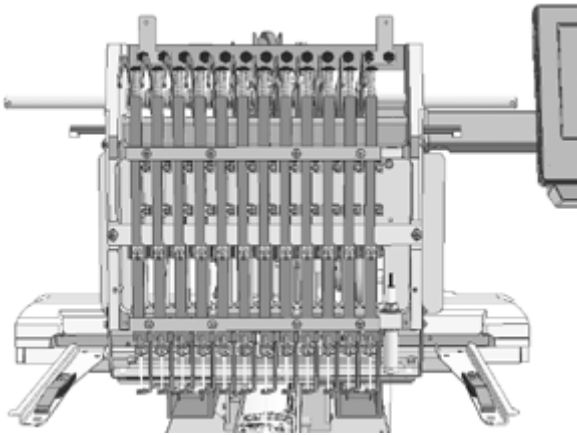

2. The needle which you insist to exchange pressure foot should be located at offset position from bed.



(1) Press  key on control box.



(2) Turn gear with finger.

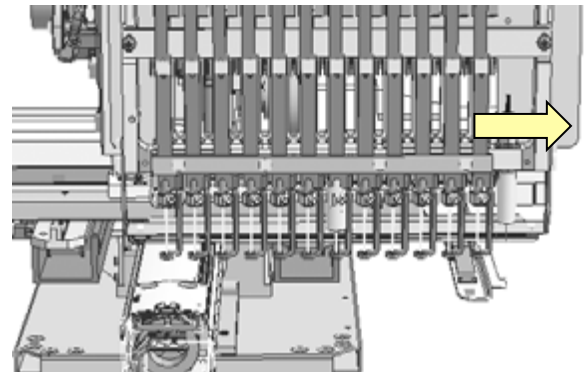
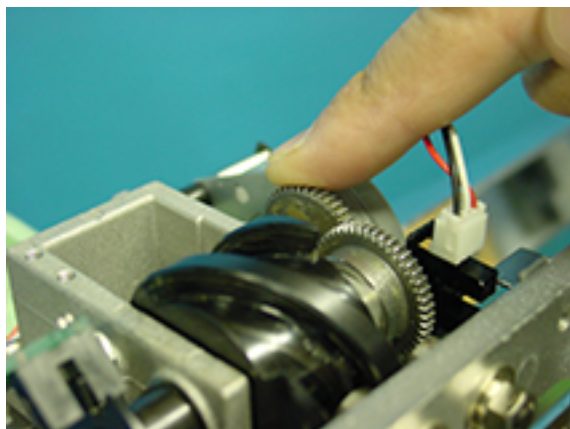

3. Remove pressure foot.

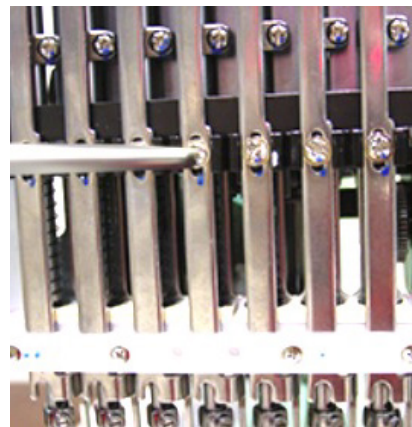

4. Install good pressure foot.

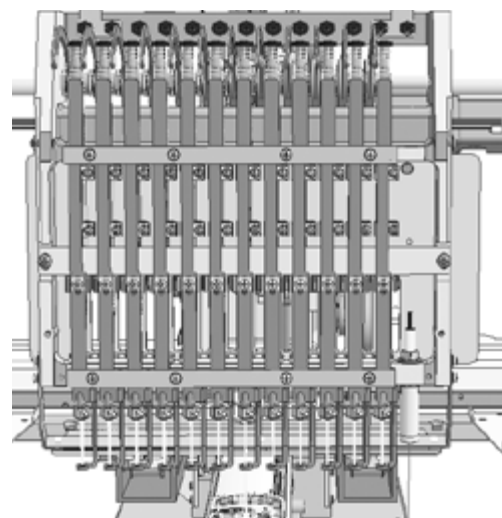

5. Adjust height of pressure foot to finish.
Please refer to [3-2-10 Check of height of pressure foot].

1. Rotate the upper shaft to be lowest point [0 degrees].

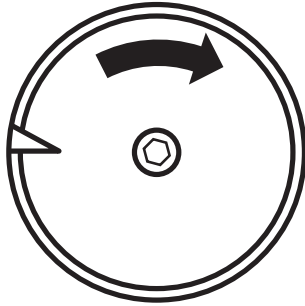

2. Turn gear by finger, then bring pressure foot guide bar down.

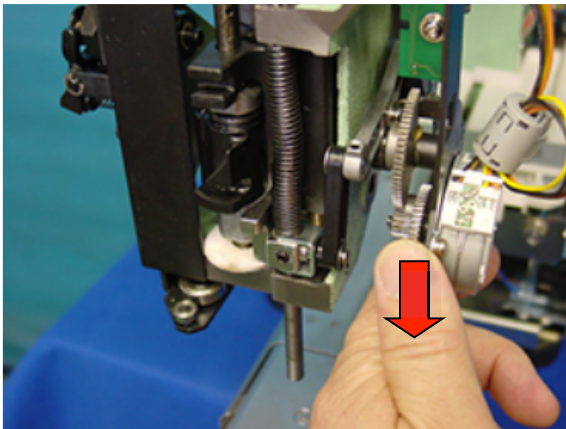

3. Please confirm that the length of pressure foot guide bar should be 37 mm.

Also confirm that the pressure foot guide bar should not touch the LM guide, when the bar goes up to top position.

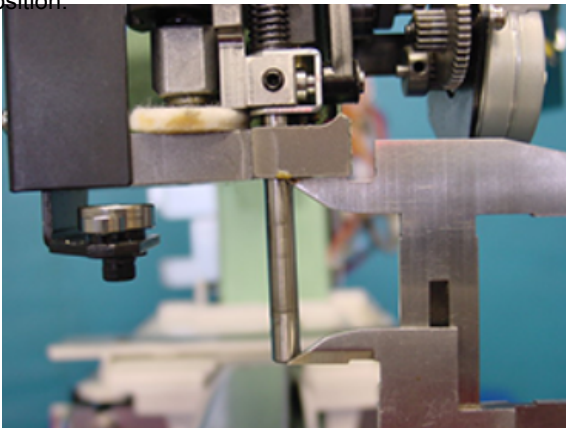

4. In case the length of pressure foot guide bar is not 37 mm, loosen the screw which fixes guide bar block and adjust it as 37mm.



Exchange of pressure foot link and block

3-2-13

1. Referring to [3-2-4 Exchange of needle bar driver], remove the Head shaft and remove the Needle bar driver ass'y.



2. Loosen the screw which fixes guide shaft then move the guide shaft lower.

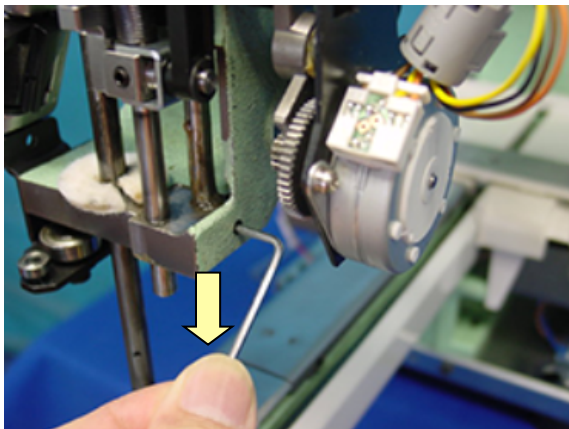

3. If you exchange block ass'y, loosen the screw which fixes pressure foot link A then remove block ass'y.



4. If you remove the pressure foot link B ass'y, first remove the pressure foot cam collar and pressure foot drive cam.

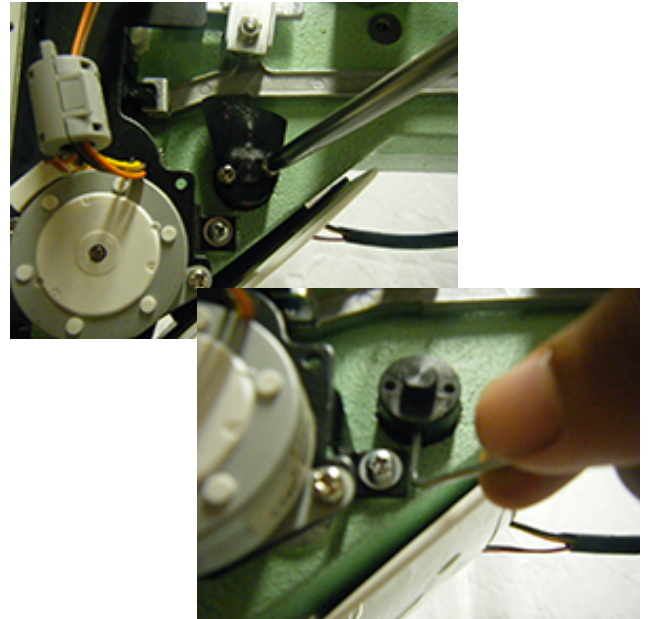

5. Remove pressure foot link B ass'y.



6. Assemble the parts by opposite procedure to terminate this exchange.

When assembling each unit, please refer to each procedure Instruction for assemble adjustment.

<Attention>

Position of guide shaft is attached to lowest and the side of Head.

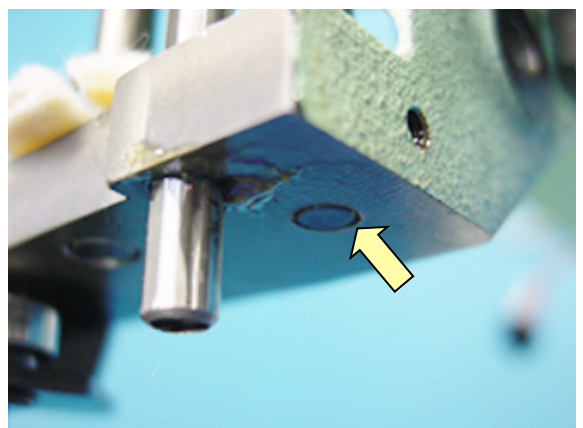

Exchange of pressure foot drive lever

3-2-14

1. Referring to [3-2-1 Exchange of crank], remove face plate.

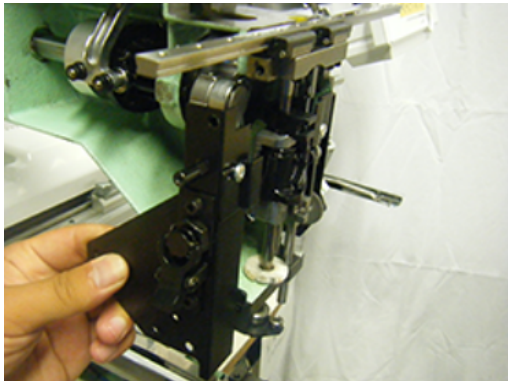

2. Remove upper rail.

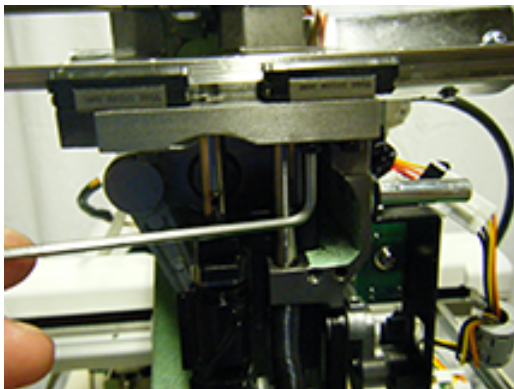

3. Loosen fixing screw of guide bar boss and bring pressure foot guide bar down.

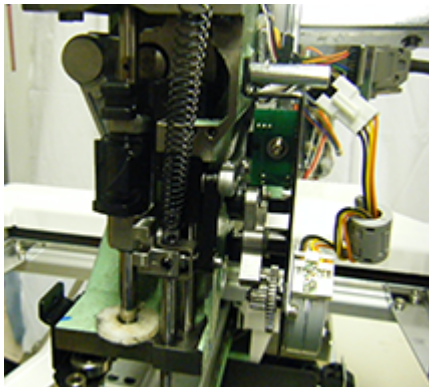

4. After remove pressure foot spring, remove pressure foot guide bar to up side.

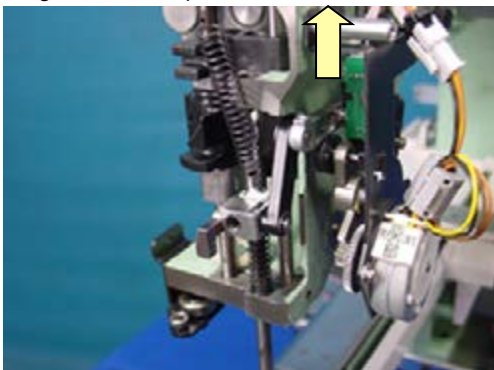

5. Remove pressure foot drive lever ass'y



6. Exchange pressure foot drive lever ass'y.

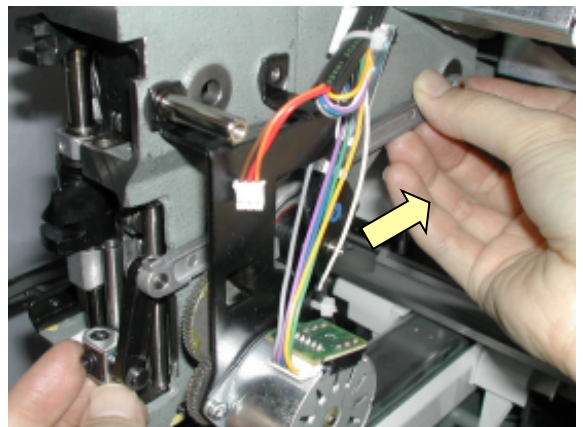

Exchange of pressure foot drive lever

7. Put on grease to body and oil bush of pressure foot lever ass'y.

<Grease>

Shell alvania EP Grease2

(Shell Gudas S2 V220 2)

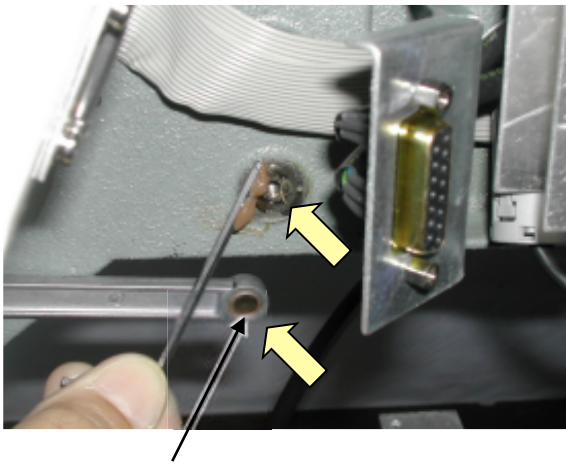

Oil insert bush

8. Put on grease to fulcrum shaft.

<Caution> Do not put on grease to a part of screw.



9. Assemble pressure foot drive lever ass'y.



10. Assemble pressure foot guide.



11. Adjust position of pressure foot guide plate A ass'y.

<Caution>

Make sure that pressure foot guide plate A ass'y is mount perpendicular and parallel to the body.

<Spanner> 7mm

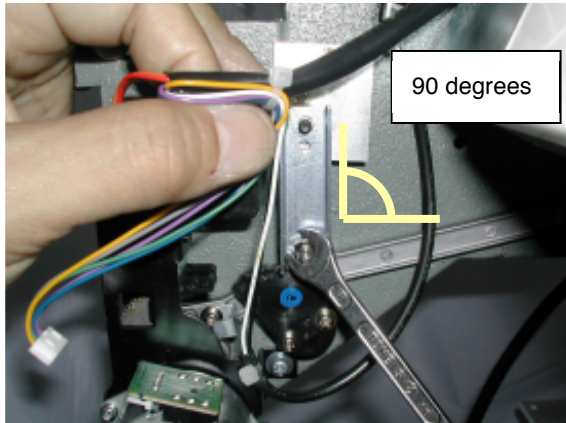

12. Adjust the height of pressure foot guide bar.

Please refer to [3-2-12 Adjustment of height of pressure foot guide bar].



13. Assemble the upper rail of moving head.

Please refer to [3-3-1 Assemble the upper rail of moving head].

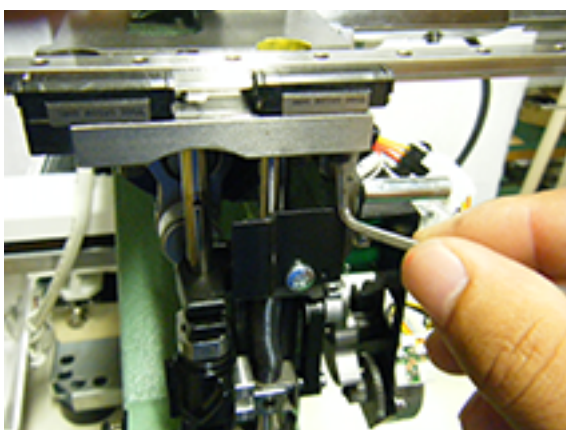

14. Assemble the Needle bar boss stopper.

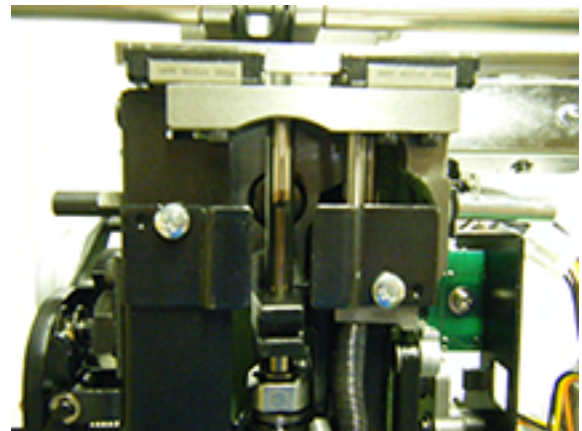

15. Assemble the face plate.

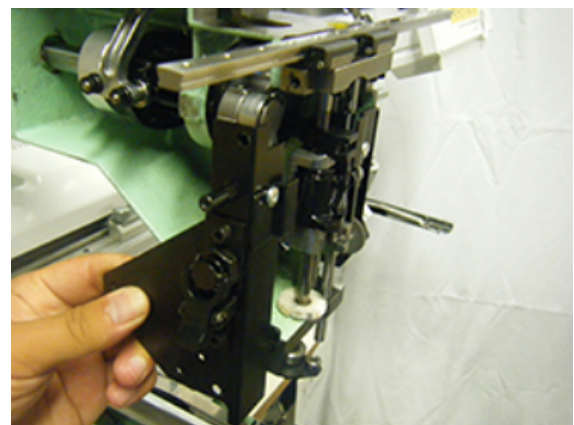

16. Install parts in reverse order to finish.

For adjustment of fixing of each unit, please refer to process to adjust fixing of each unit.

Exchange of pressure foot guide

3-2-15

1. Referring to [3-2-1 Exchange of crank], Remove face plate (left) ass'y and moving head.

Loosen the screw and move the Guide bar boss B lower.

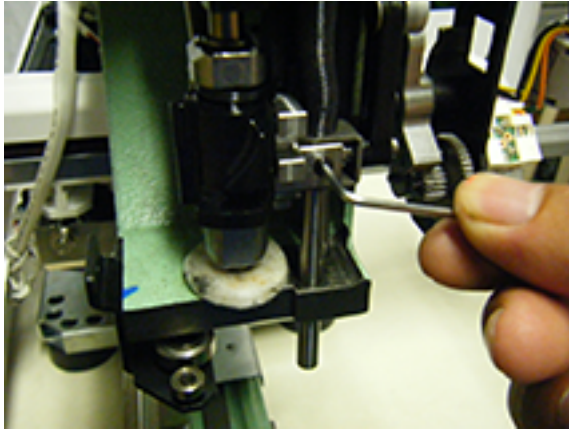

2. Remove pressure guide bar.

After remove pressure foot spring, remove pressure foot guide bar to up side.

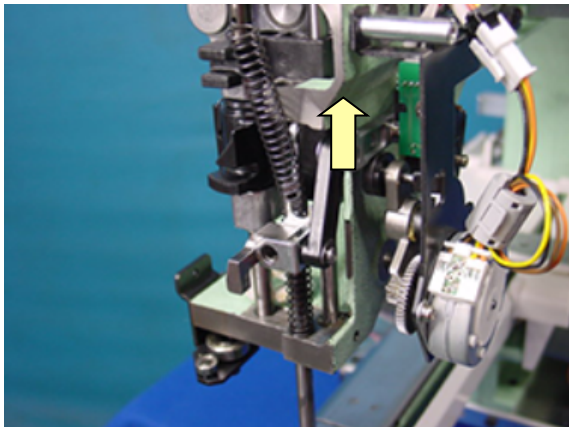

3. Remove E-ring (E-4) which fixes guide bar boss.

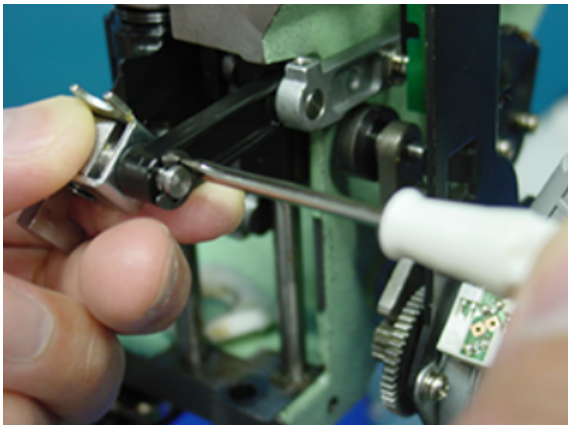

4. Exchange guide.



5. Assemble the pressure foot guide bar and Pressure foot spring.



6. Adjust the height of pressure foot guide bar to finish.

Please refer to [3-2-12 Adjustment of height of pressure foot guide bar.]

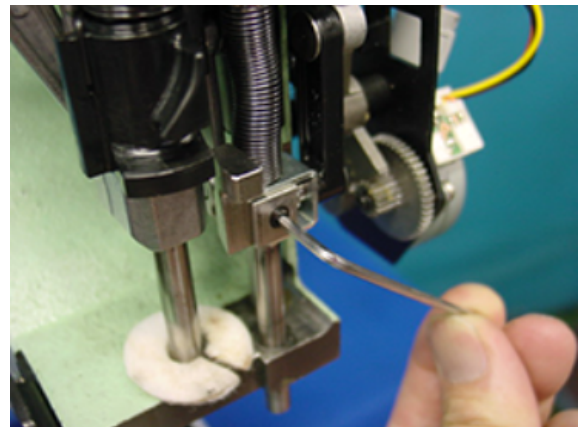

Exchange of pulse motor for pressure foot

1. Change needle bar to no. 0 and disconnect cable from pulse motor.

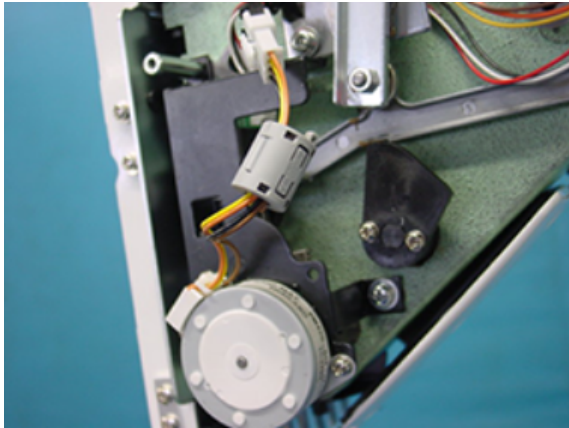

2. Down the Pressure foot.

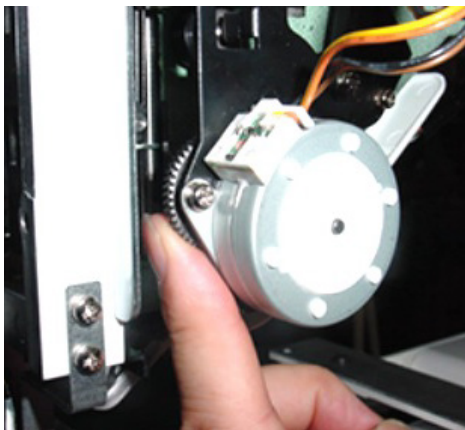

3. Disconnect cable from Sensor board ass'y and Remove bracket ass'y.

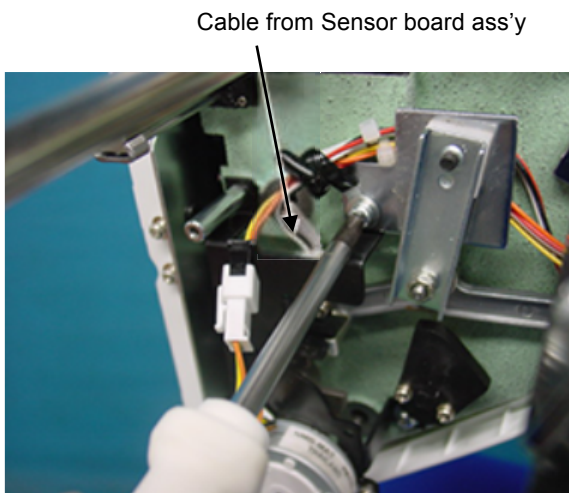

4. Remove drive gear A.

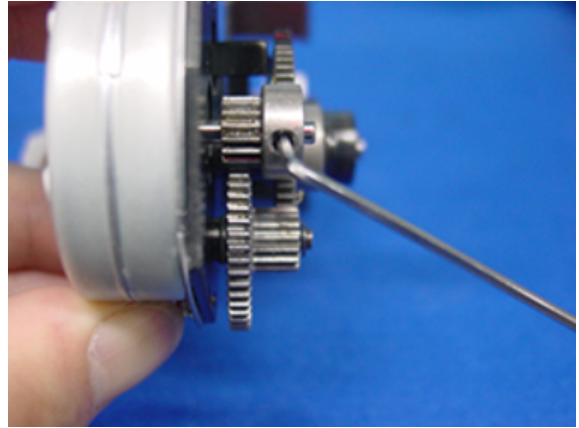

5. Exchange the pulse motor.
Fix it temporarily.

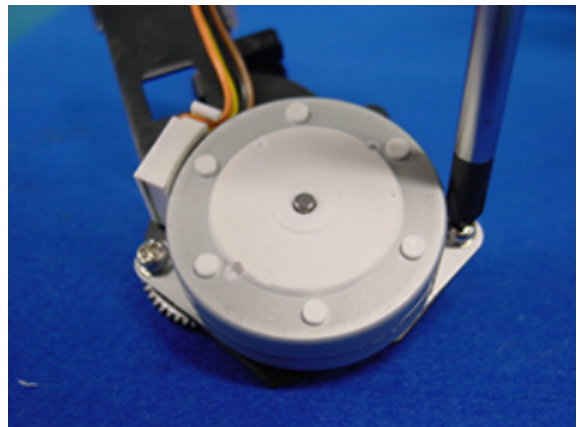

6. Assemble the drive gear A.
The position should come to the middle of the gear range.

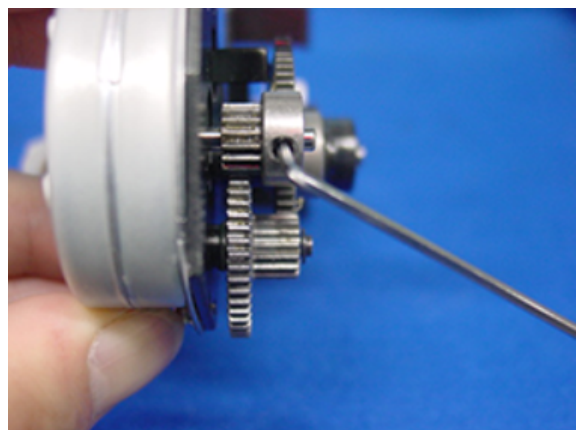

7. Adjust position of pulse motor then fix it.

Keep slightly backlash between drive gear A and gear.

(Every point.)

Remove clamp filter from original motor, then re-set to new motor.



8. Continue to conduct [Adjust the pressure foot bracket ass'y].

Please refer to [3-2-17 Adjustment of pressure foot bracket ass'y].

Adjustment of pressure foot bracket ass'y

3-2-17

1. Fix pressure foot bracket ass'y tentatively.

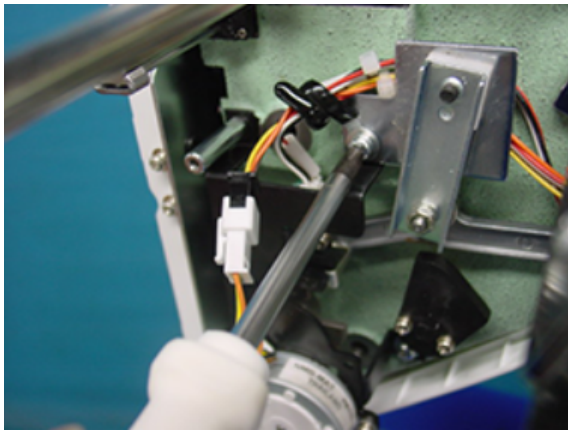

2. Lift up pressure foot.

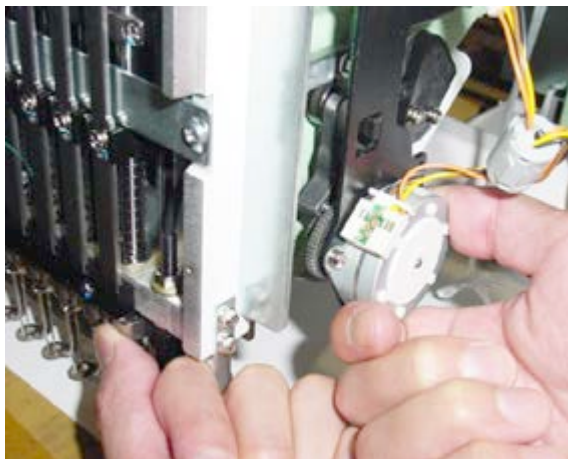

3. Pull pressure foot bracket ass'y downward, then fix it.

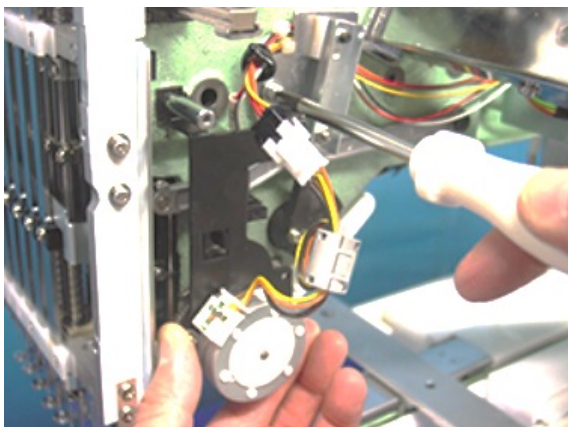

4. Adjust position of pressure foot guide plate B ass'y.

<Caution>

Make sure that pressure foot guide plate B ass'y is mount perpendicular and parallel to the body.

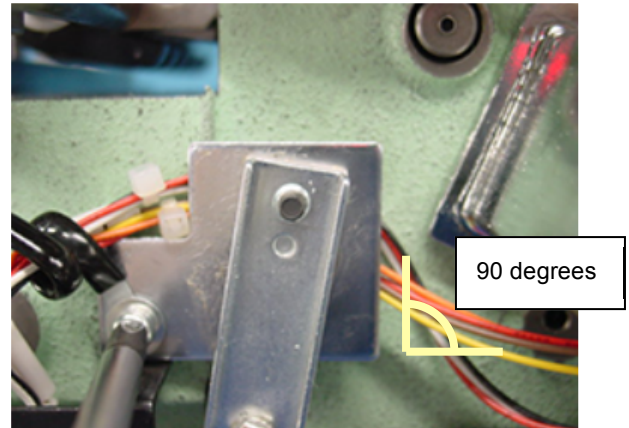

5. Procedure is done after confirming the pressure foot

movement by pressing the  on control box.



Exchange of thread catcher

3-2-18

1. Tighten the screws securely while pushing thread catcher unit in the direction of the arrows of the following figure to fix the unit.

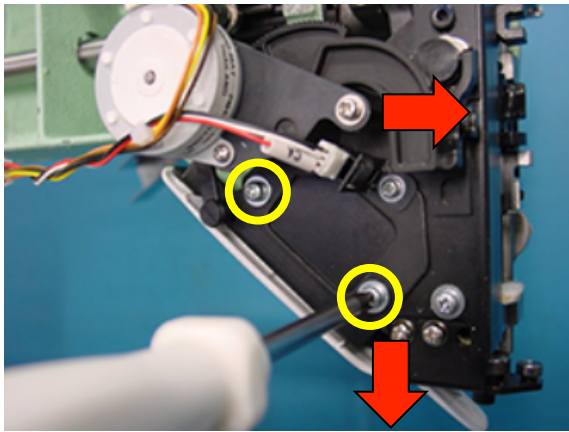

2. Loose screw of sensor for thread catcher unit a little bit.

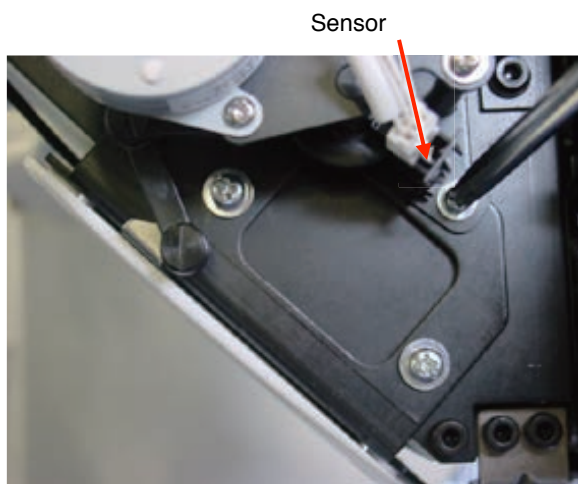

3. Refer to "5-6-11 How to enter maintenance mode" and enter maintenance mode.

4. Press **Machine Test**.

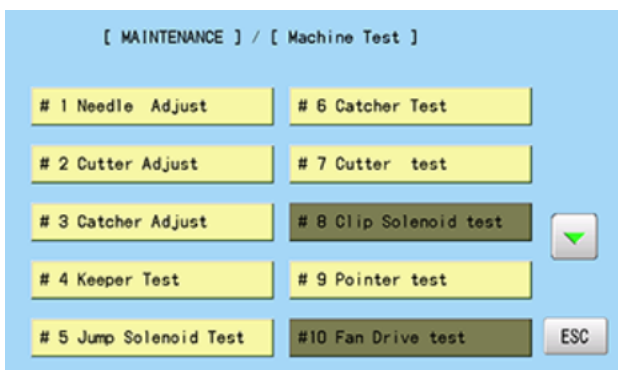

5. Press **Catcher Adjust**, take thread catcher unit in and out, and move and adjust the sensor shown in the direction of the arrow so that the dimension in the following figure meets the value in the following figure when hook goes back. Fix the sensor with setscrew after adjustment.

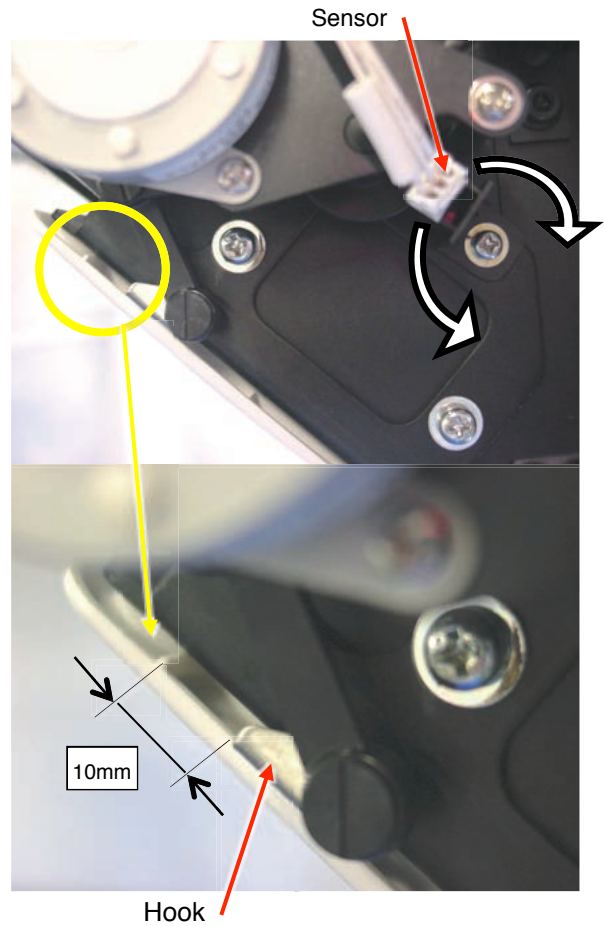

6. Continue to "Adjustment of thread holder".

When you adjust thread holder, you might need to adjust thread catcher unit again.

Follow the procedure in "3-3-13 Adjustment of thread holder."

Adjust if the thread is leans to one side.

1. Assemble the winder bracket ass'y tentatively.

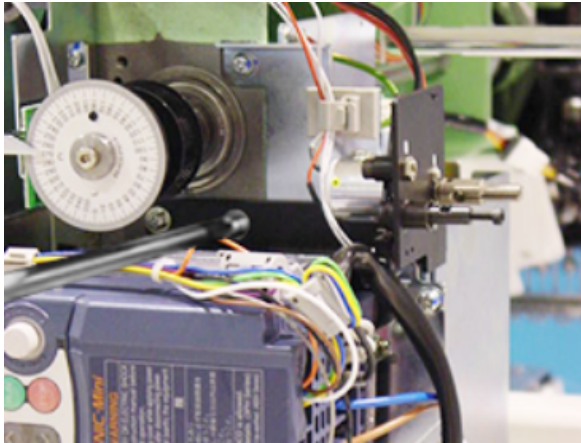

2. Assemble the left cover with keeping the space between shaft and the cover hole.



3. Assemble thread tension ass'y.

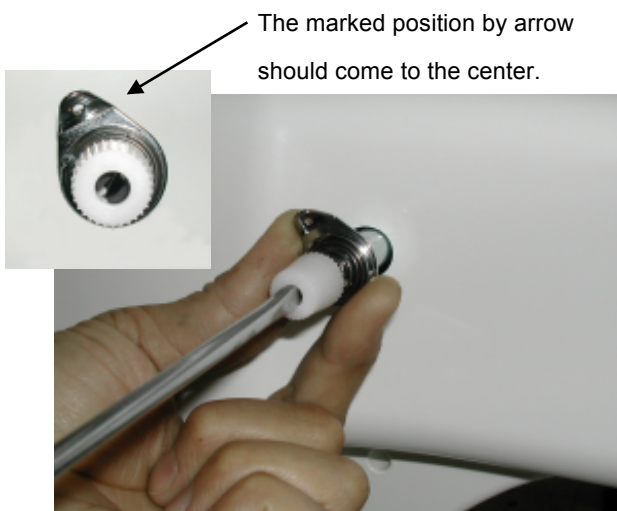

4. Assemble guide as tentatively.



5. Confirm that the shaft does not touch the cover by turning motor.
(Set the empty bobbin and down the Guide.)



If the guide touches the bobbin adjust position of the winder bracket ass'y.

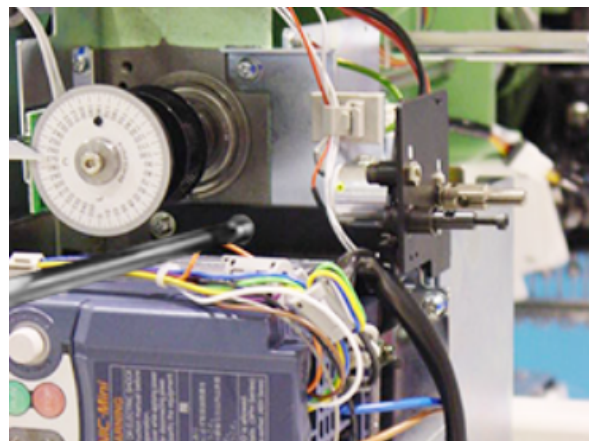

6. Adjust bobbin thread tension [30g] by tension gauge.



7. Rewind the bobbin thread.



8. Adjust the inclination of Winder bracket ass'y in accordance with thread winding condition.

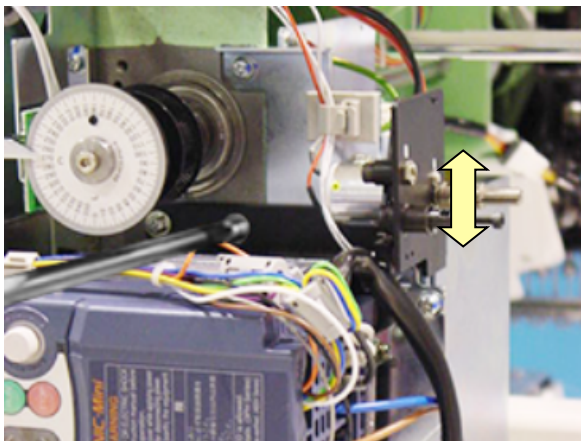

9. Adjust the height of Guide to adjust volume of thread to be wound.

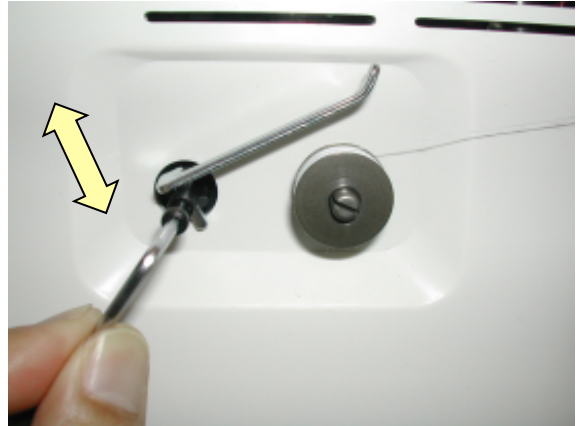

10. Reinstall the parts which has been removed.

Assemble the upper rail of moving head

3-3-1

1. Tighten right and left LM guide base.

Follow in picture, keep push to allow way each LM guide base.

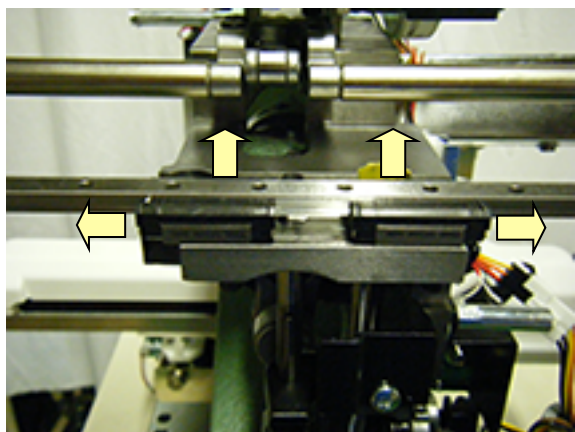

<Notice>

Should be front side which letter on side of LM guide base.

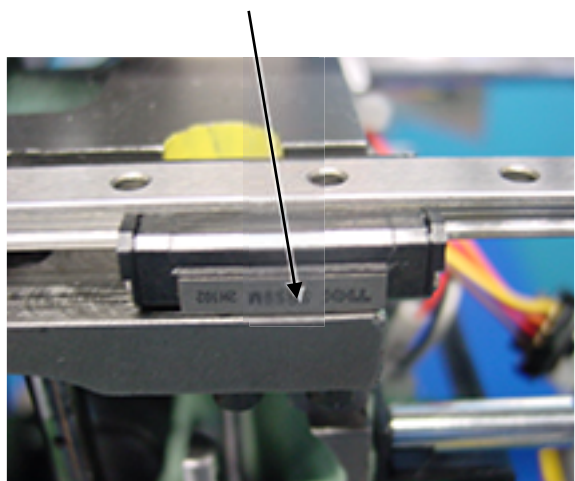

1. Adjust positioning roller shaft so as to put moving rail (lower) between bearings.

Move moving head back and forth so as not to cause backlash.

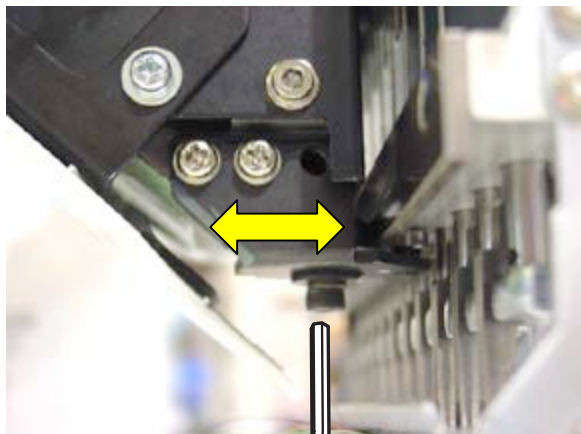

2. After adjustment, check and adjust needle drop to finish
Please refer to [3-3-4 Adjustment of needle position (back and forth)].

Assemble the moving head

1. Please confirm that the position of needle bar change unit is set at 12th needle.

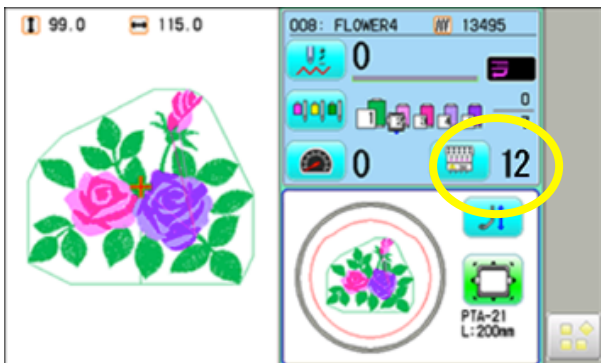

2. moving head を 12th needles の位置で、Install moving head tentatively.

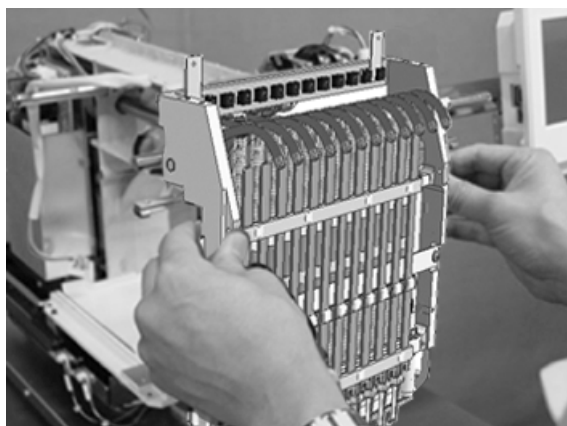

<Caution>

Screw head not to come out from LM guide side.

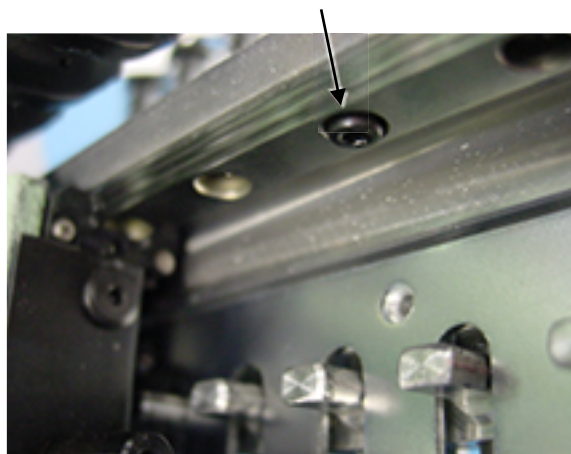

3. Put in SIMM [0.05mm] between a moving head and LM guide.

* Don't tighten a screw only by inserting SIMM here.
Please give

<Caution> Do not lost simm material.

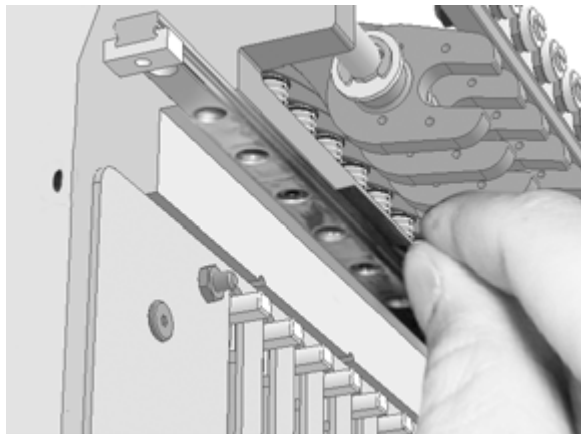

<View of behind>

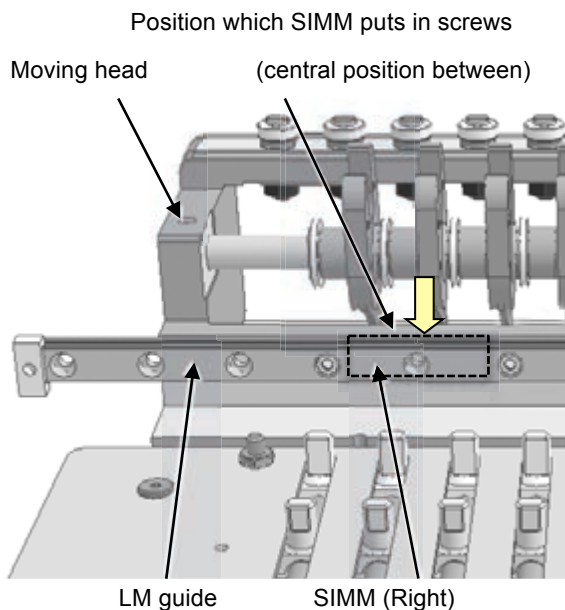

<View of right side>

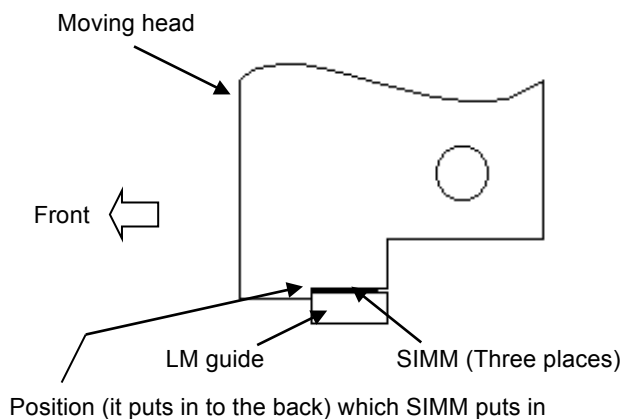

Assemble the moving head

4. Turn the drive shaft B screw for manual operation, and make it the 1st needle.

* When a moving head is caught on the way and does not carry out horizontal movement.

The screw tightened tentatively in "the work procedure 1" has come out from LM guide.

A screw from LM guide. Please fasten.

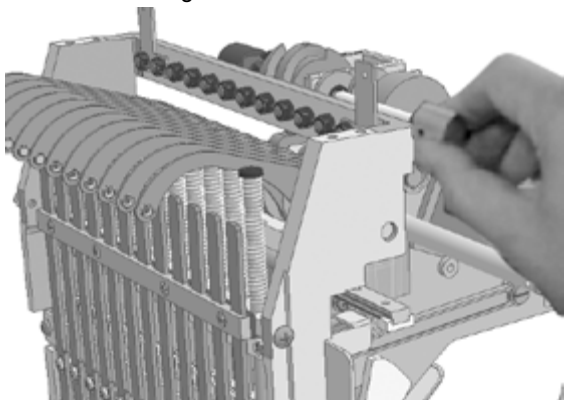

5. Put in SIMM [0.05mm] between a moving head and LM guide.

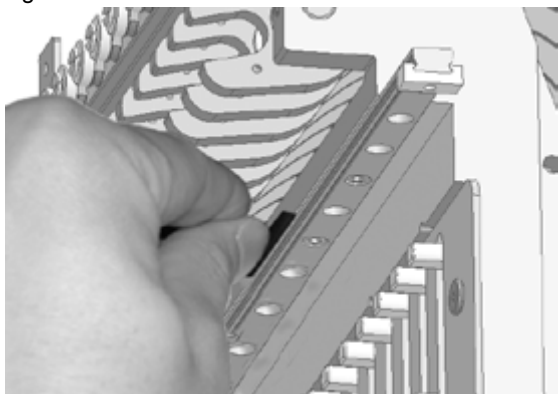

<View of behind>

To puts in (central position between screws)

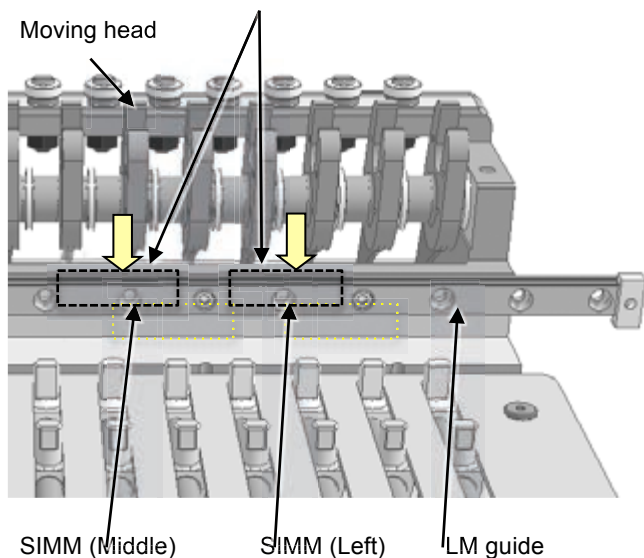

<View of left side>

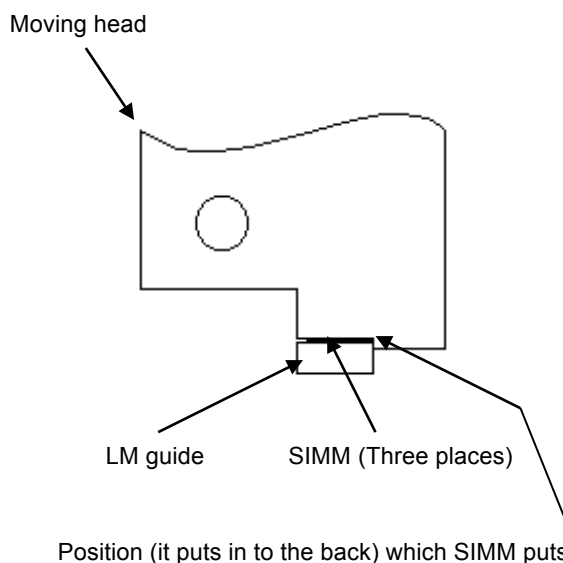

* Don't put in SIMM but push up a moving head lightly a case.

<important>

Please do not lower LM guide by any means.

There is a possibility that LM guide may bend.

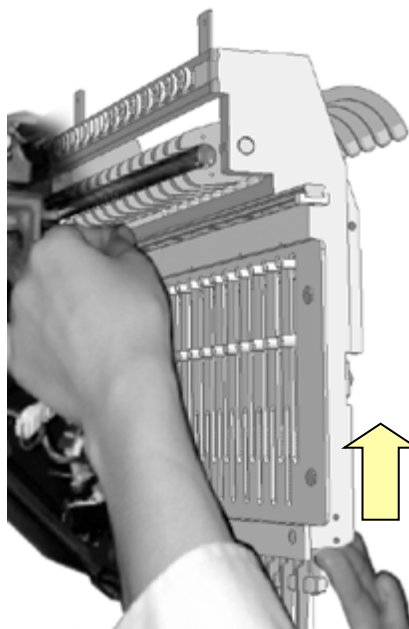

Assemble the moving head

3-3-3

6. Tighten an inside screw (arrow portion in a figure).

<important>

Please perform a screw bundle in order of "inside to outside."

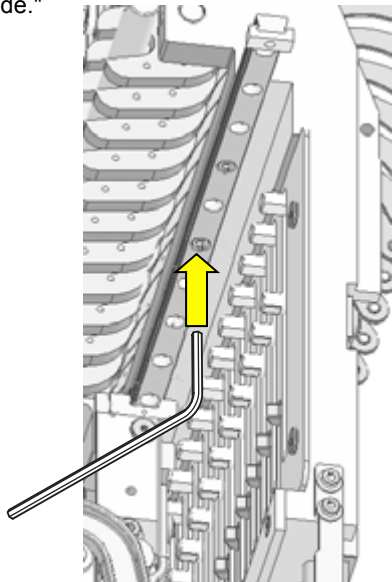

At this time, a moving head is pushed from the front and it is LM guide.

It is made for there to be no crevice.

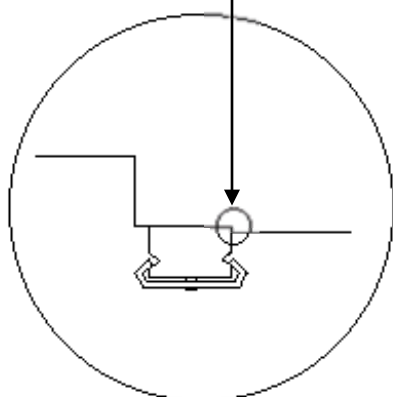
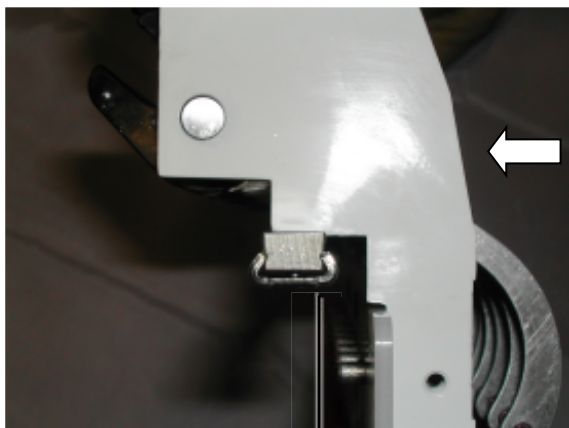

7. An outside screw (arrow portion in a figure) is tightened.

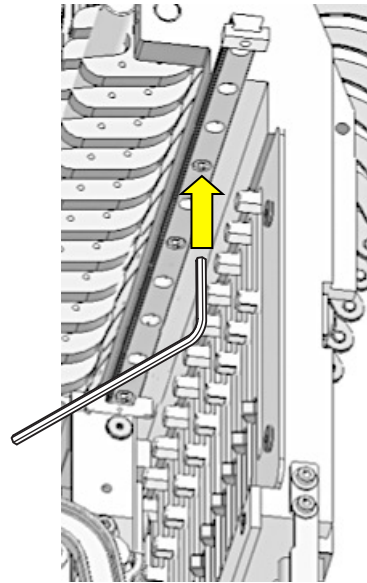

8. Turn the drive shaft B screw for manual operation, and make it the 12th needles.

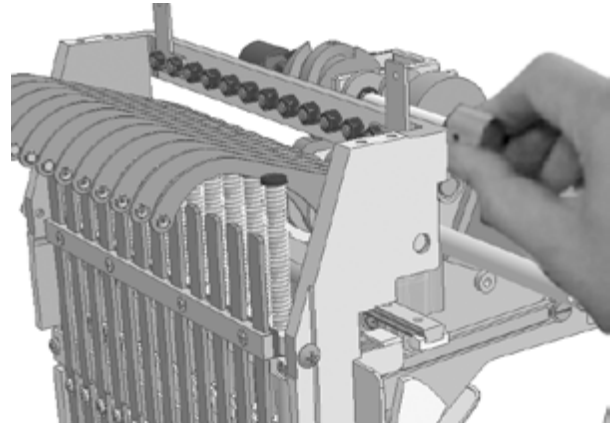

9. Tighten an inside screw (arrow portion in a figure).

<important>

Please perform a screw bundle in order of "inside to outside."

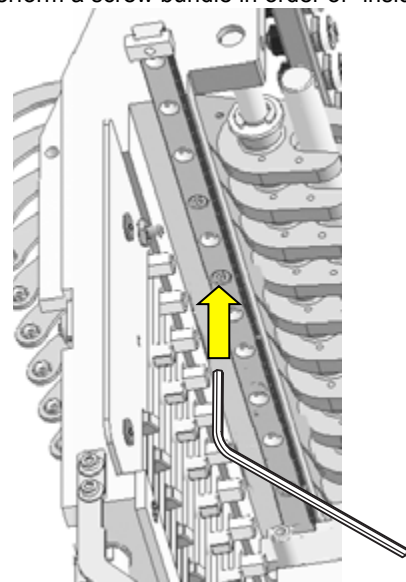

Assemble the moving head

3-3-3

At this time, a moving head is pushed from the front and it is LM guide.

It is made for there to be no crevice.

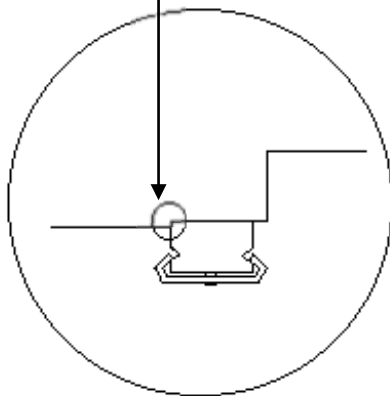
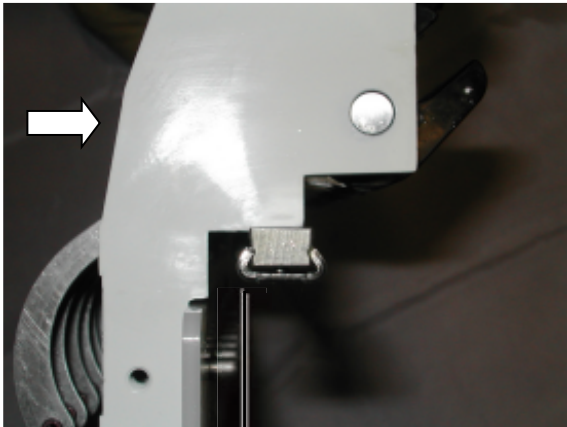

10. Tighten an outside screw (arrow portion in a figure).

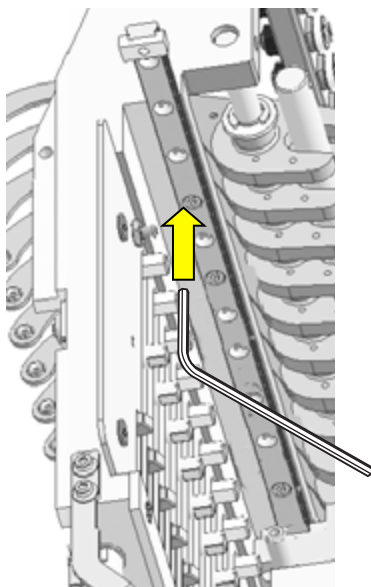

11. Check center (right and left)(back and forth) of needle and needle hole of needle plate.(Needle No.1 ,6 and 12.)

<Caution>

Should be check needle No.1 ,6 and 12.

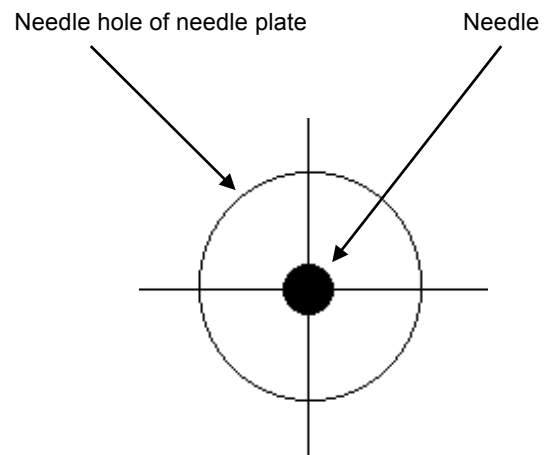

12. If not center (back and forth),please adjust needle position (back and forth).

Refer to [3-3-4 Adjustment of needle position (back and forth)].

13. If not center (right and left), please adjust again procedure 6-10.

14. If "OK". Please check [needle position].

Refer to [3-3-5 Check of needle position].

If "NG" this process, adjust again procedure 12-13.

Adjustment of needle position (back and forth)

3-3-4

1. Bring pressure foot down. (Either way mentioned below)

(1)press  key on control box.

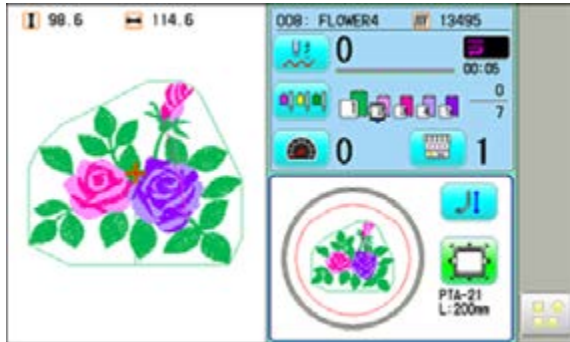

(2)Turn gear with finger.

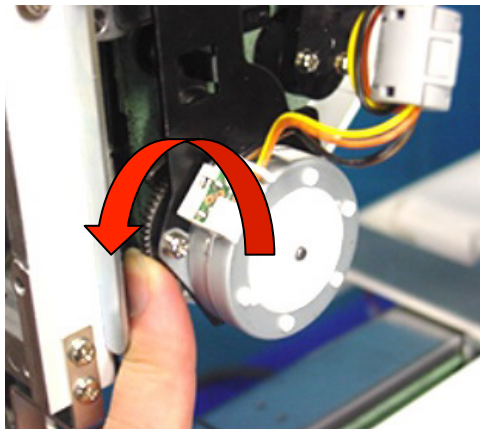

2. Bring needle bar down by finger.

Also you can move down the needle bar by maintenance mode through menu of control box.

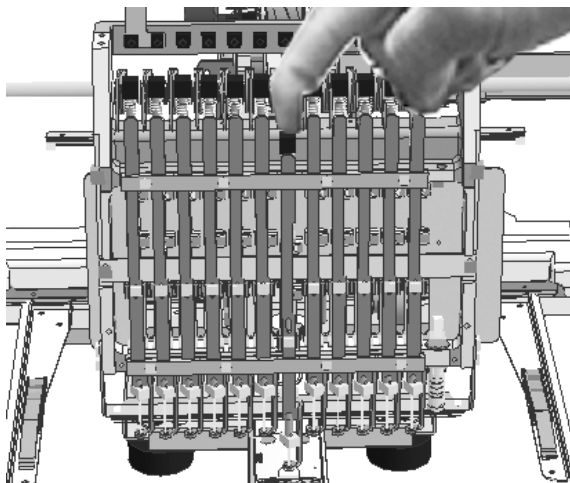

3. Turn upper shaft and set needle near to the lowest needle position [L] to adjust positioning plate ass'y.

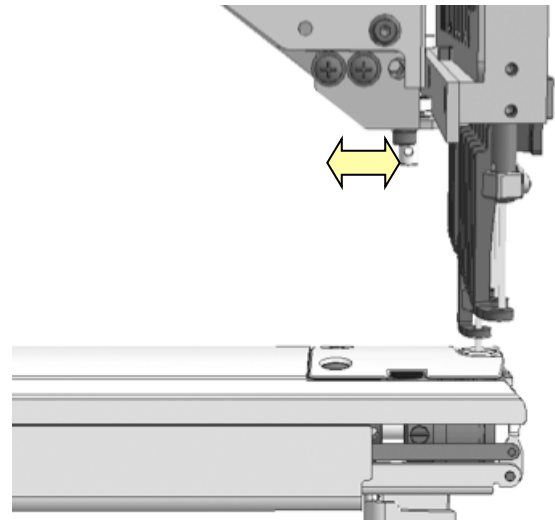

* Insert Lower rail to between the two bearing deeply.
(This is for setting of Moving head completely.)

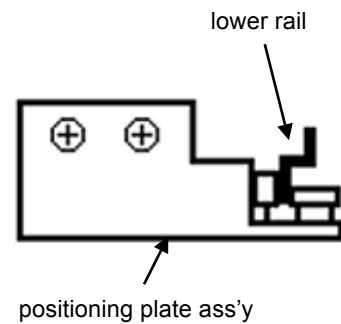

Viewing from side, set to center of needle hole.

#Check and adjust with 1st, 4th and 7th needle.

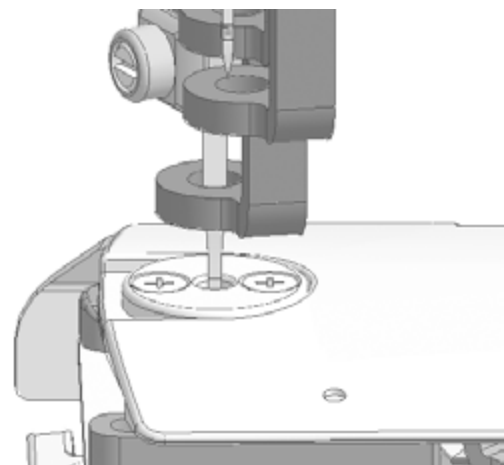

4. After adjustment, please be sure to check and adjust clearance between needle and shuttle hook.
Please refer to [3-5-1 Adjustment of rotary hook timing].

Check of needle position

1. A main switch is turned on.

The **Next** is pressed and it changes into an operation state.



2. Press and make it the 4th needles.

3. Stick a seal on needle hole of a needle plate.

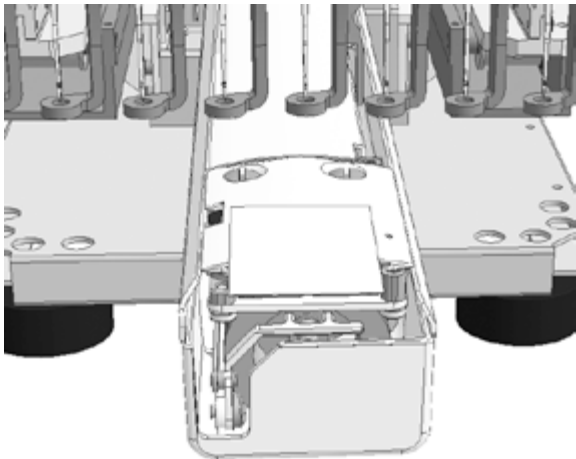

4. Bring pressure foot down. (Either way mentioned below)



(1)press **P FOOT** key on control box.

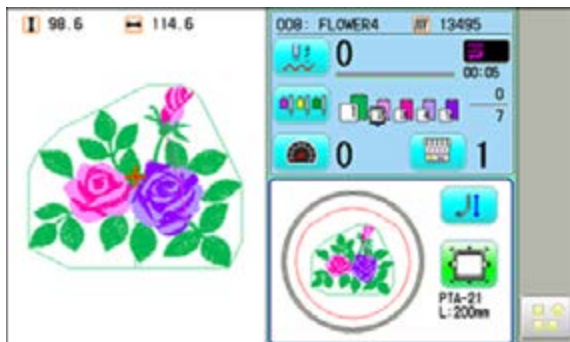

(2)Turn gear with finger.

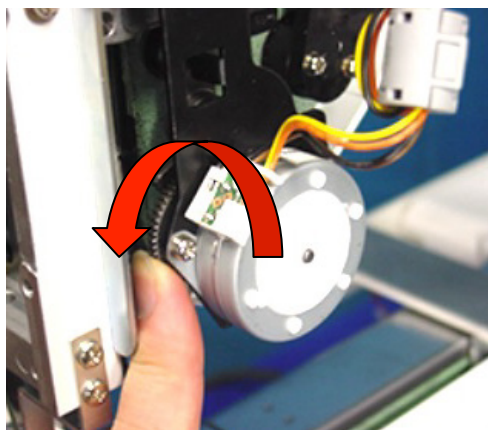

5. Bring needle bar down by finger.

Also you can move down the needle bar by maintenance mode through menu of control box.



6. Turn an upper axis up to [302 degrees - 303 °], and it is the needle mark to a seal. A hole is made.

<Note> Needle point will become large if the angle of a dial disc is made into 304 degrees or more.

An exact needle position check becomes impossible.

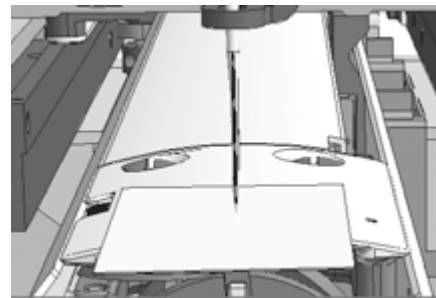

7. Reverse-rotate an upper axis, raise a needle bar, and unite with C [275 degrees].

(It returns to 303 degrees-> 220°, and unites with 275 degrees after that.)

<Note> If a top axis is right-rotated, a needle will enter deeply, and needle hole is greatly.

It becomes. Therefore, an exact needle position check becomes impossible.

8. 1st needle and the 7th needles are to 302 degrees - 303 degrees about an upper axis by the above-mentioned procedure. It turns, a needle is lowered and a needle position is checked.

It will be O.K. if the needle point goes into the seal hole made by the 4th needles at this time.

* If "NG". Please adjust again, follow to [3-3-3 Assemble the moving head] of procedure 6-10.

* 303°→ Diameter of φ0.2mm、310°→Diameter of φ0.5mm

The order which the screw which is fixing the move head fastens -- from an inner side. If it does not carry out correctly outside, a needle position will shift -- it is --

9. Un-stick a seal on needle plate to finish.

Adjustment of needle height

1. Referring to [3-2-1 Exchange of crank], remove lower front panel.

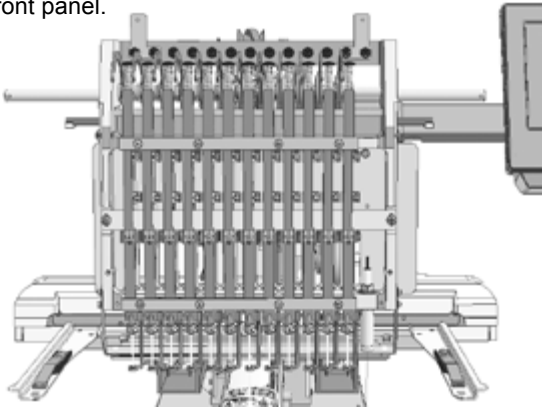

2. Remove bobbin case.

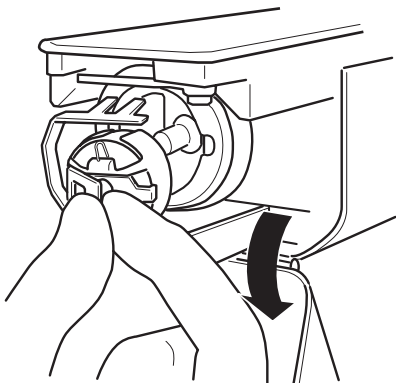

3. Bring pressure foot down. (Either way mentioned below)

(1)press  **P_FOOT** key on control box.

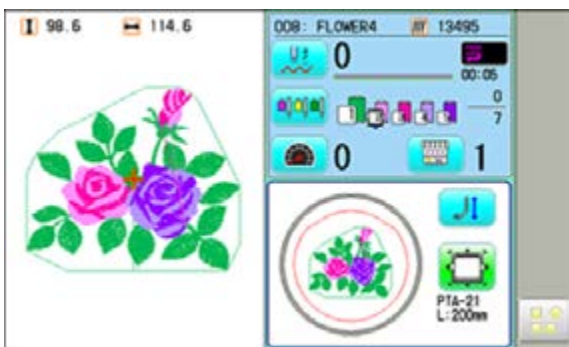

(2)Turn gear with finger.

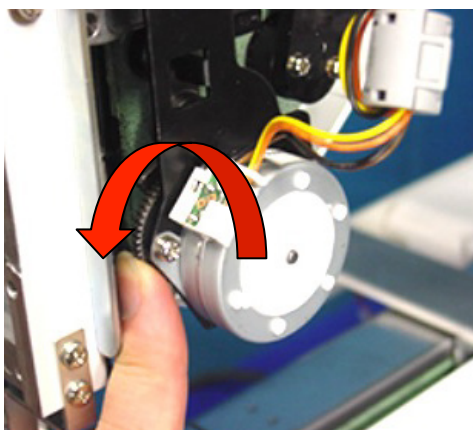

4. Bring needle down.

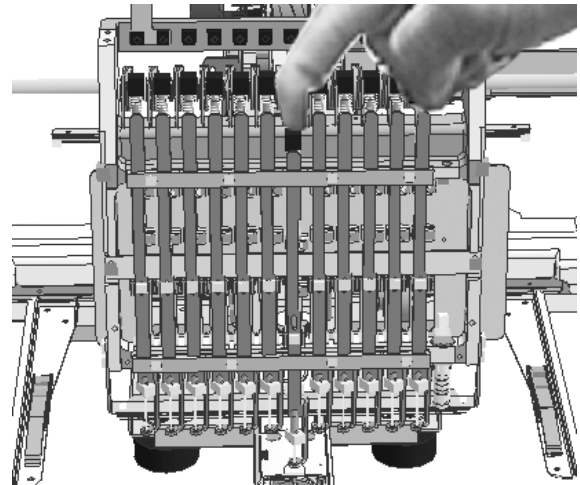

5. Turn upper shaft to set dial disc to [5 degrees].

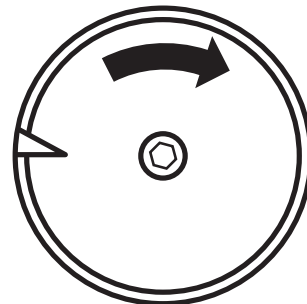

6. Loosen needle bar boss and needle bar boss B.

Needle bar boss B



Needle bar boss

Adjustment of needle height

3-3-6

7. Put needle height gauge in rotary hook.



8. Adjust the needle bar height up and down till the needle tip touches to the gauge slightly.



9. Set direction of needle stop as illustrated below.

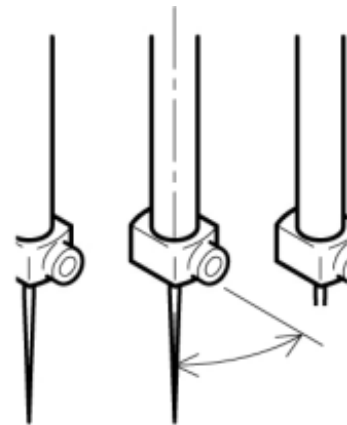

About 30 degrees

10. Tighten the screw of needle bar boss.



11. Bring pressure foot down and Turn upper shaft to set dial disc to [270 degrees]..

12. Tighten the screw of needle bar boss B.

When tightening needle bar boss B, please insert Calliper (pre-set as 25.3mm) in-between.

* Check the movement of needle bar goes smoothly.

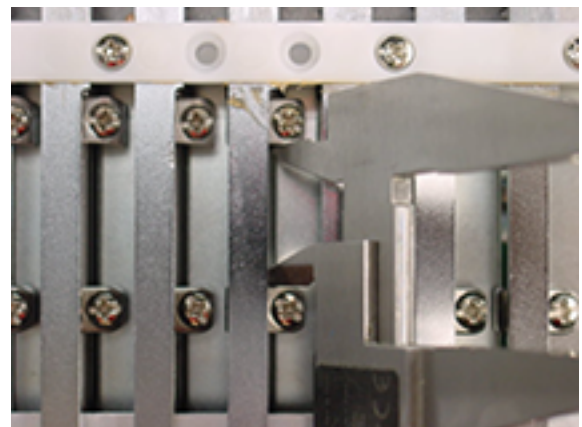

13. Put things back in reverse order of 1-2 to finish.

Exchange of needle bar and needle bar spring

1. Referring to [3-2-1 Exchange of crank], remove lower front panel.

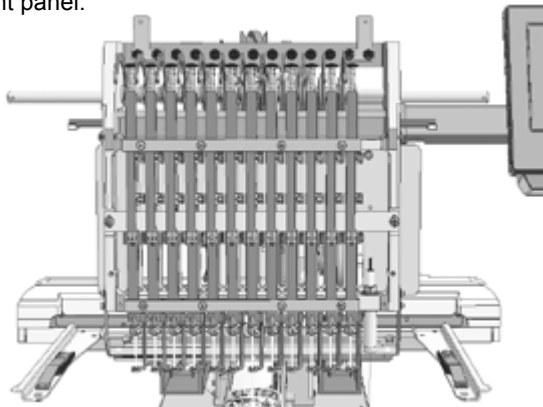

2. The needle which you insist to exchange needle bar should be located at offset position from bed.



(1) Press  key on control box.

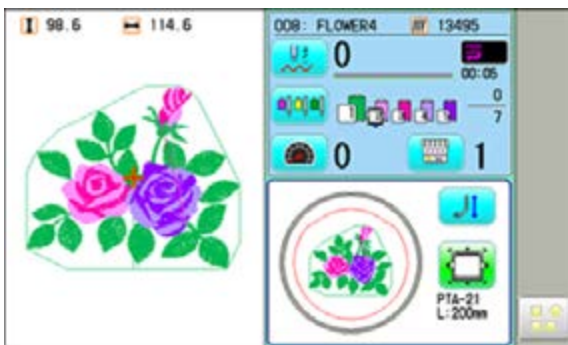

(2) Turn gear with finger.

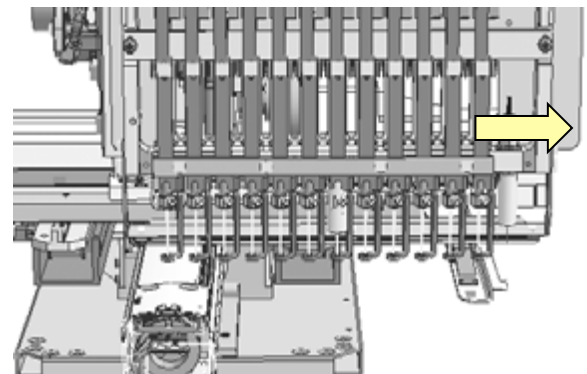
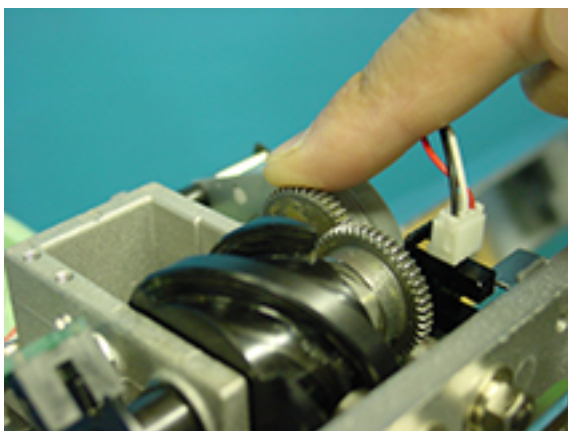

3. Remove needle, needle holder and pressure foot.



4. Loosen needle bar boss and needle bar boss B.

Needle bar boss B

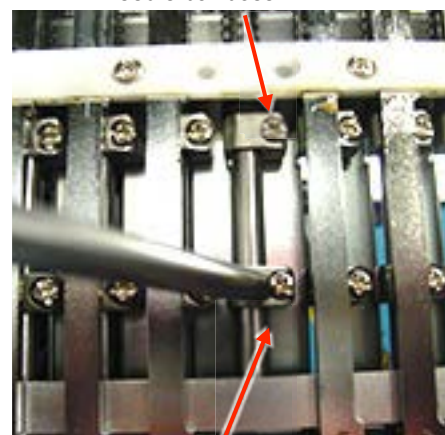

Needle bar boss

Exchange of needle bar and needle bar spring

3-3-7

5. Pull out needle bar.

At this moment, remove needle bar boss, needle bar boss B, Needle bar spring H, Pressure foot block B, Pressure foot spring, Cushion and Plain washer (M6).



6. While pressing needle bar spring, insert good needle bar with needle bar boss, needle bar boss B, Pressure foot block B, Cushion, Plain washer (M6), Needle bar spring H and Pressure foot spring.



7. Fix needle , needle holder and pressure foot.

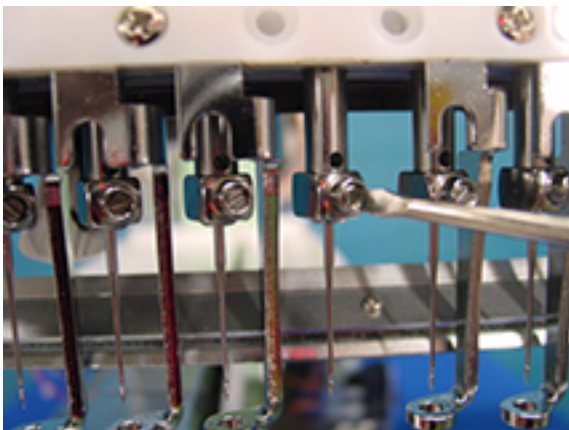

8. Adjust needle height.

Please refer to [3-3-6 Adjustment of needle height].

9. Put removed parts back to finish.

Fixing of needle bar boss guide plate

3-3-8

1. Referring to [3-2-1 Exchange of crank], remove moving head.

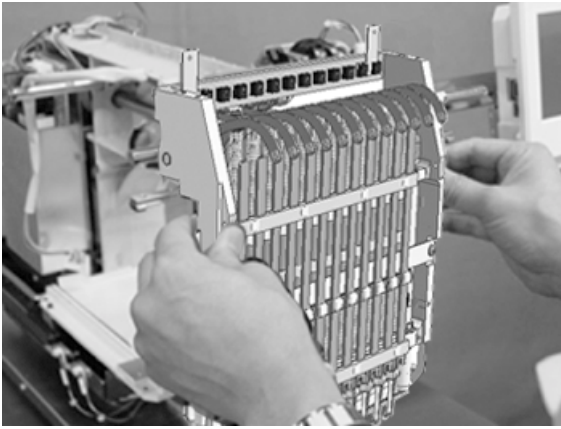

<Caution> Do not lost simm material.

2. Remove Clamp of laser pointer cable.

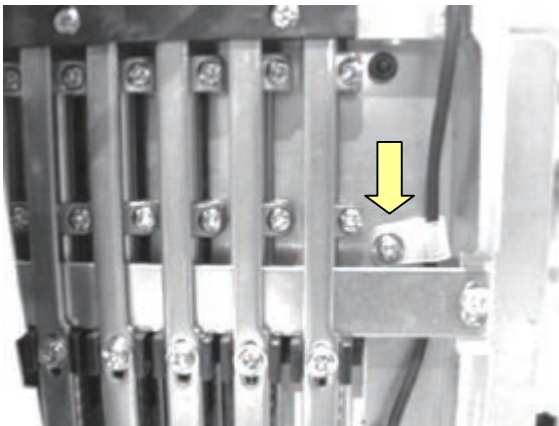

3. Remove boss screw.

Please note that you need hexagonal driver for front screw and spanner (4mm for rear nut as photo below).

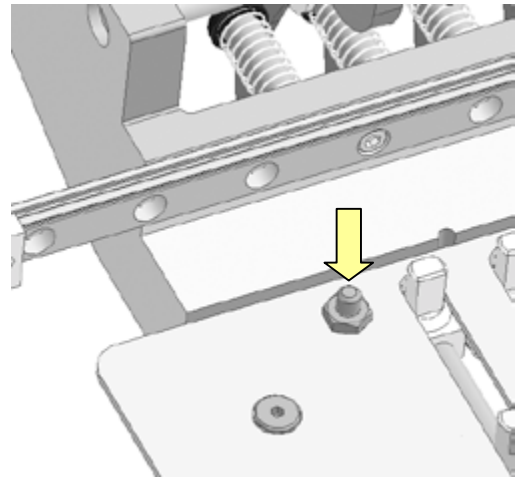
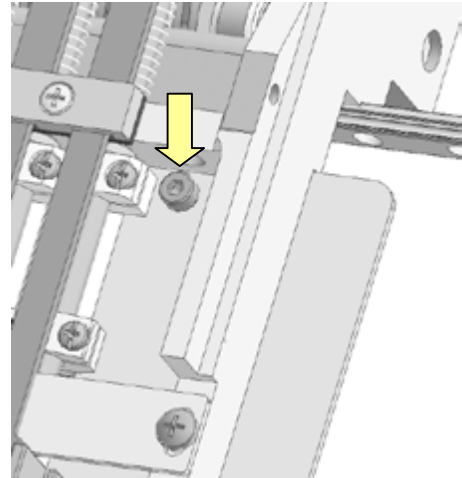

4. Exchange of needle bar boss guide plate and fix it.

Push needle bar boss check plate to arrow marked direction and keep the length of both sides equally as photo below, then fix screws.

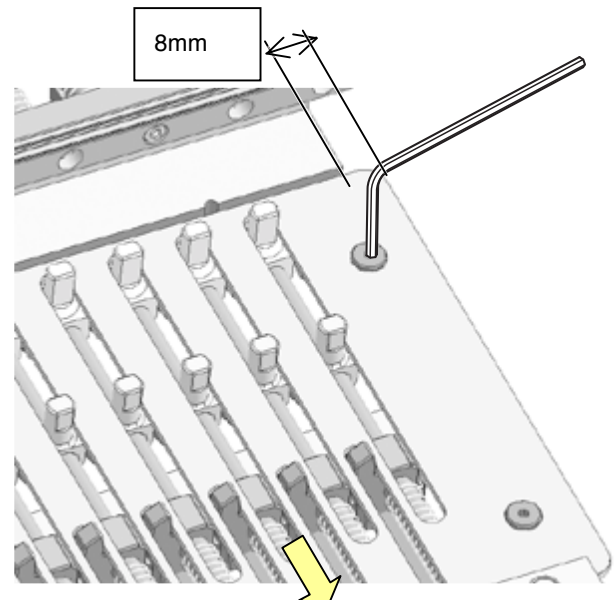

5. Fix boss screw again.

6. Fix Clamp of laser pointer cable temporary.

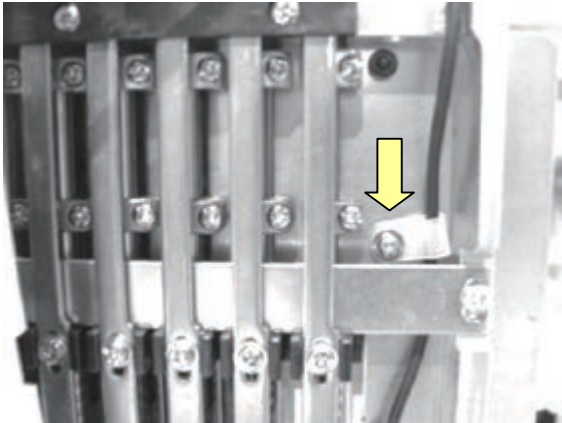

7. Referring to [3-3-3 Assemble the moving head],
Put moving head and other removed parts

8. Adjust height of block plate and confirm that pressure foot
block B should goes into groove of guide bar boss B as
photo below, then fix screws.

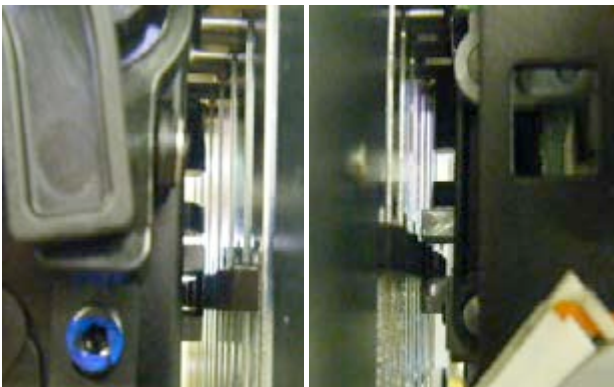

9. Put moving head and other removed parts back to finish.

Exchange of take-up lever

3-3-9

1. Referring to [3-2-1 Exchange of crank], remove moving head.

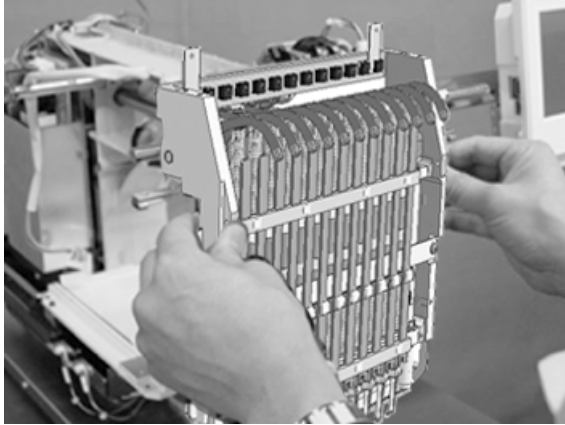

<Caution> Do not lost simm material.

2. Loosen screw on take-up shaft.

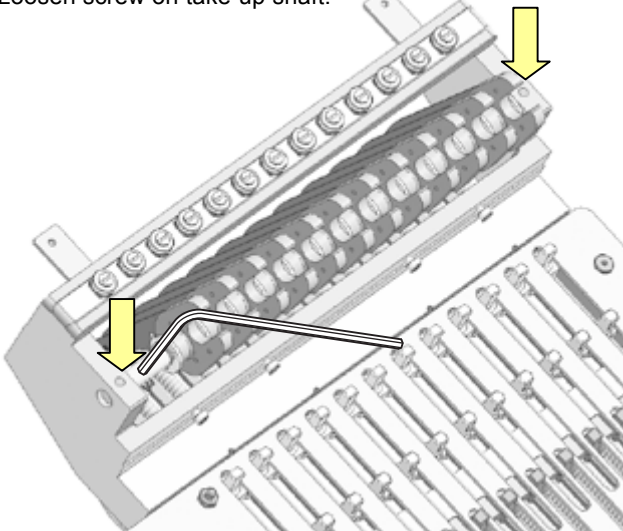

3. Remove the E-ring.

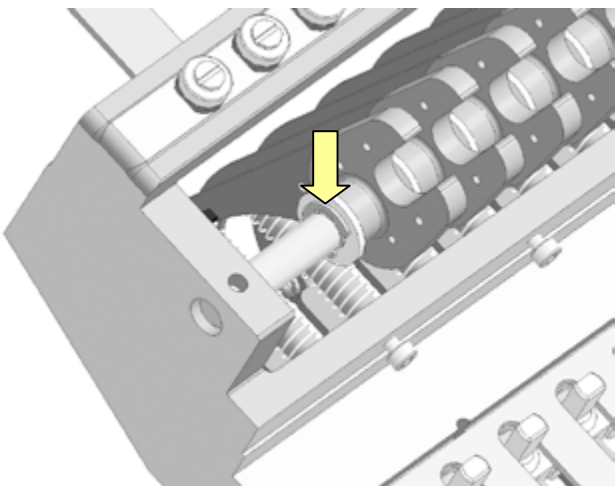

4. Remove the take up lever shaft first then remove the take-up lever and plastic washer.

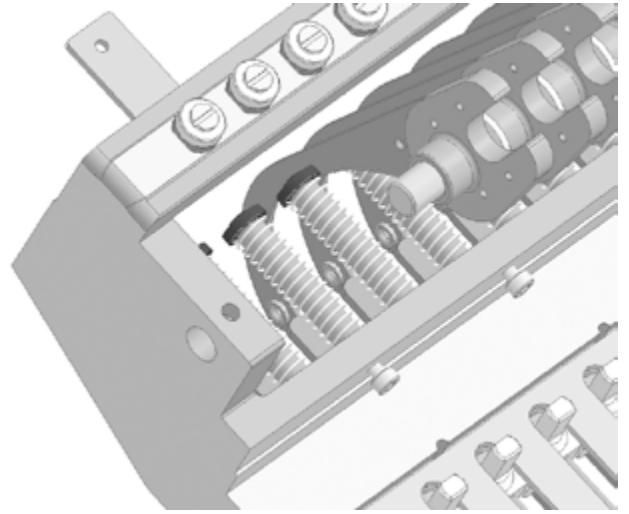

5. Install take-up lever and plastic washer.

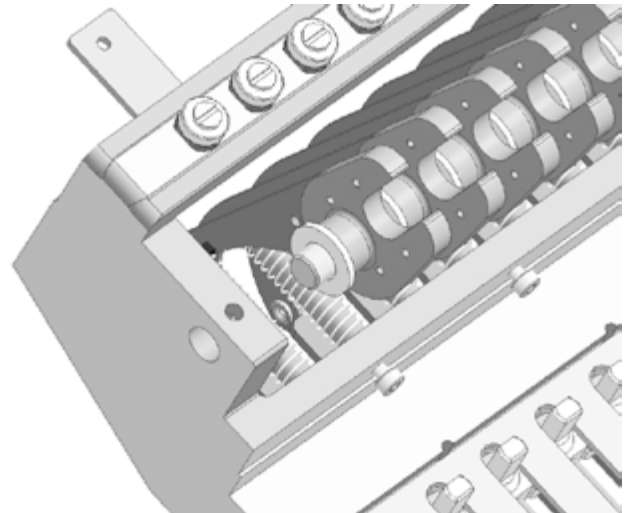

6. Set the E-ring.

Leave space of [0.03mm] between take-up lever and plastic washer.

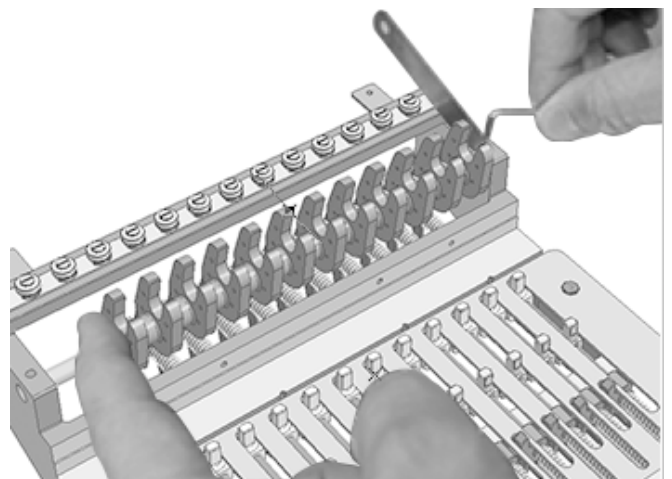

7. Put moving head in previous position to finish.

Exchange of thread adjusting spring

1. Referring to [3-2-1 Exchange of crank], remove Front cover.

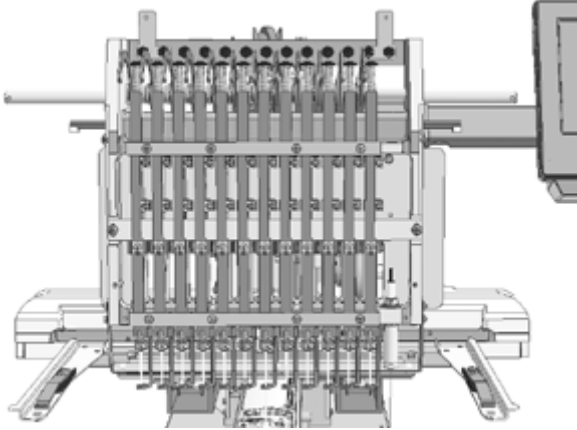

2. Remove Thread guide ass'y.

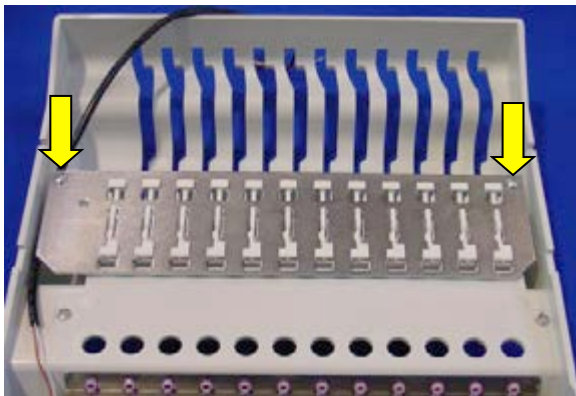

3. Insert (-) screw driver as picture below and slide the thread guide to arrow marked direction, then you can remove the thread guide.

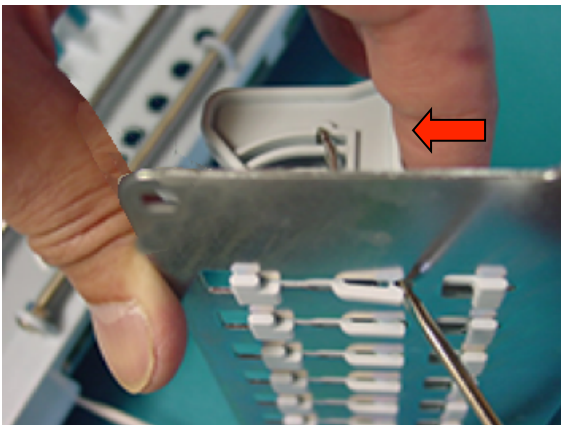

4. Remove Thread adjusting plate and Thread adjusting spring.

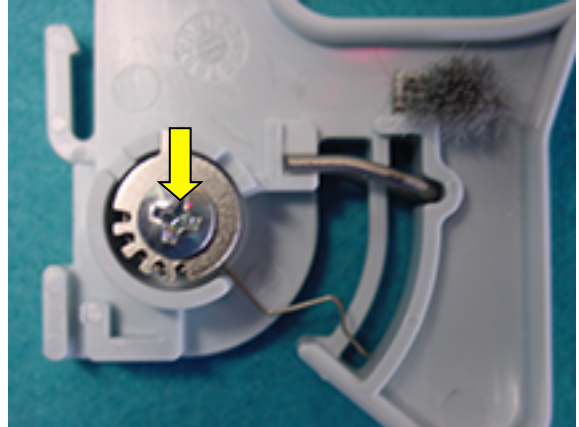

5. Exchange thread adjusting spring.

Set the thread adjusting plate and thread adjusting spring to same position as picture below.

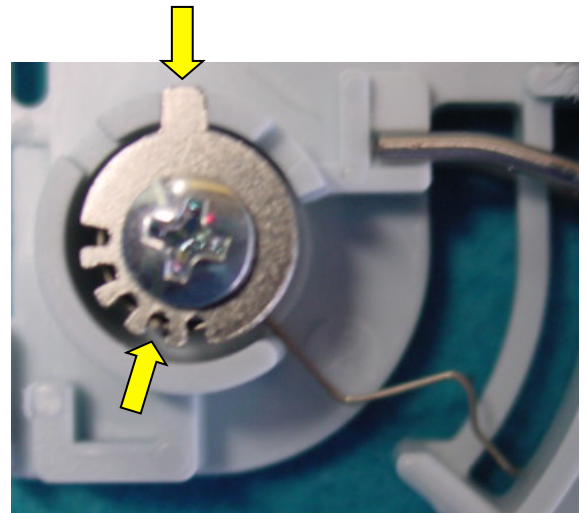

6. Put removed parts back in reverse order.

1. Referring to [3-3-10 Exchange of thread adjusting spring], remove Thread guide.



2. The Thread adjusting plate has a latch to be able to adjust tension in three steps.

Loosen screw of the thread adjusting plate, then you can adjust the latch to desired position.

Also the thread adjusting plate have five spring grooves for fine adjustment.

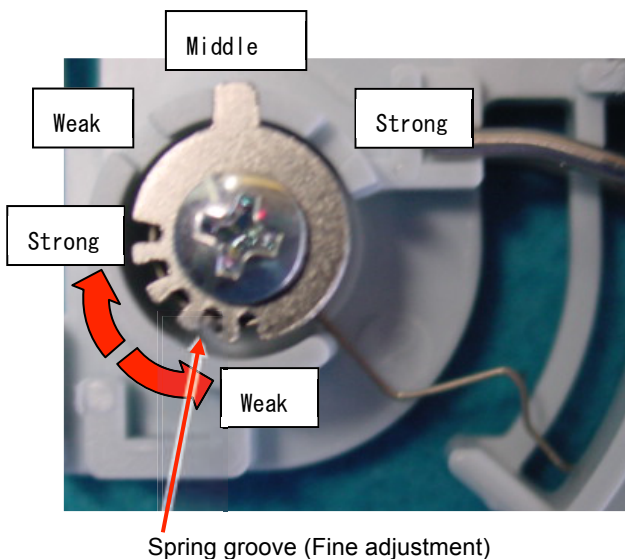

3. Put removed parts back in reverse order.

Adjustment of laser pointer

1. Referring to [3-2-1 Exchange of crank], remove Font cover.

Do not disconnect the laser pointer cord.

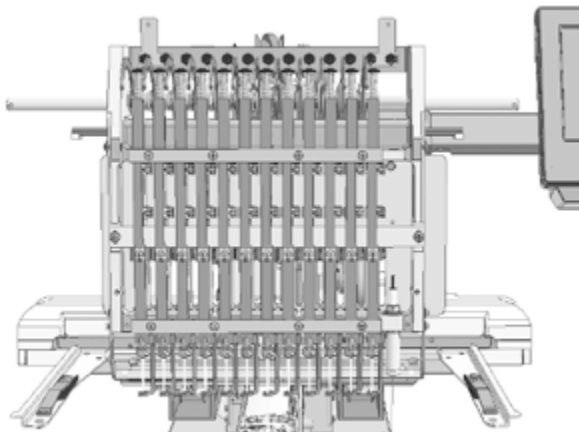

2. Set paper on needle plate and make hole on the paper.
In the case of a cross laser pointer, please make each 1 hole in the left, right, up or down which separated about 20 mm from the first hole.

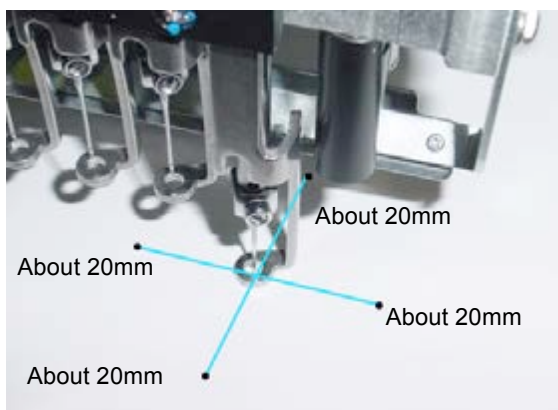

3. Hold the laser pointer unit by 10mm wrench, Loosen nut to the extent that laser pointer unit moves.

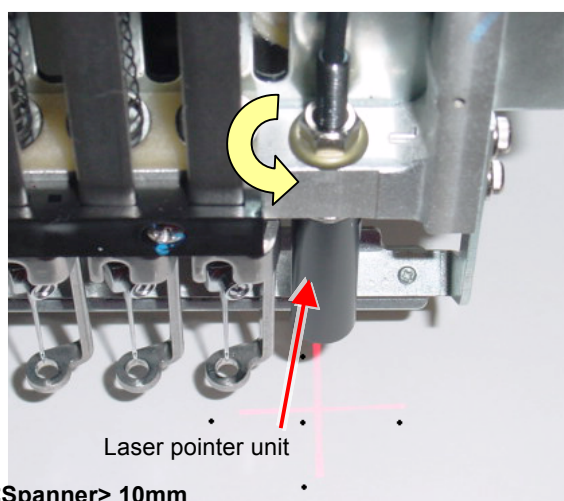

4. Press  key on display of control box.



5. Adjust position of laser pointer that the ray of laser should go into the needle hole.
Fix the nut.

Laser pointer (DLP)

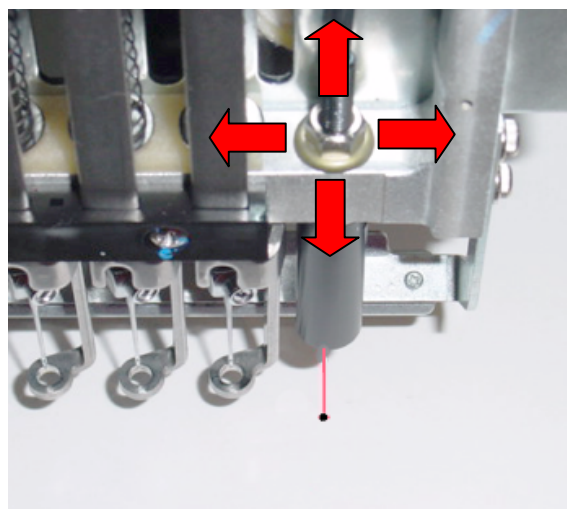

Cross laser pointer (CLP)

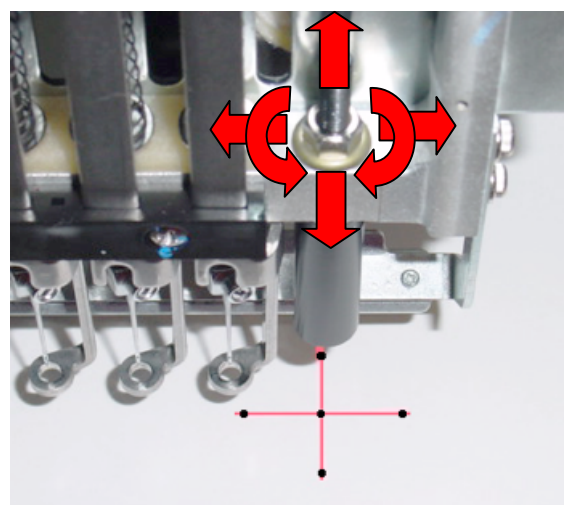

6. Put moving head and other removed parts back to finish.

Adjustment of thread holder

1. Referring to [3-2-1 Exchange of crank], remove Font cover.

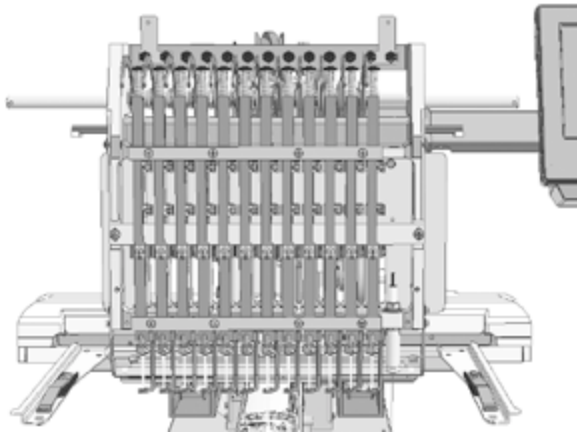

2. Loosen screw to the extent that thread holder moves.

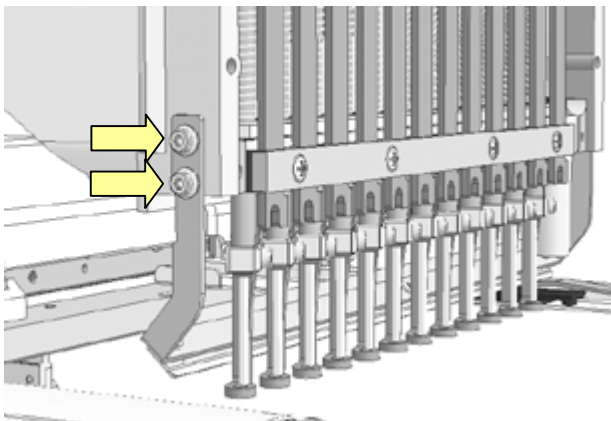

3. Bring pressure foot down. (Either way mentioned below)

(1)press  on control box.



- (2)Turn gear with finger.

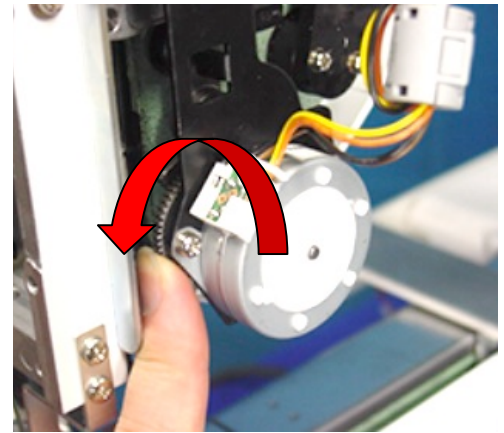

4. Take the hook in and out by finger to check movement of hook goes smoothly.
Check this at 1th , 4th , 7th needle.

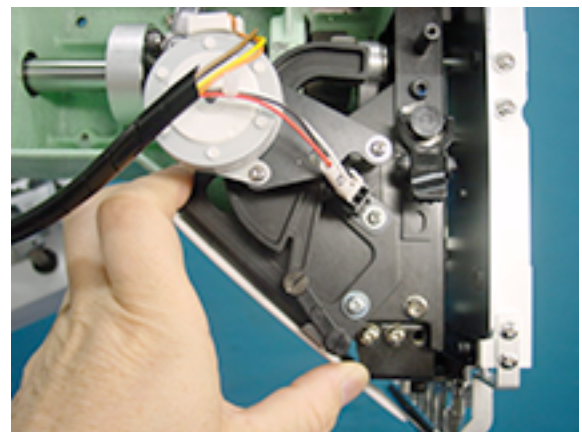

<Positional relationship between hook and holder (lower)>

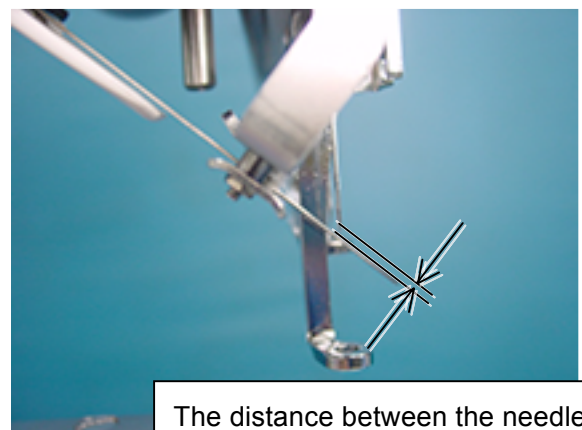

The distance between the needle tip and the hook is needle tip and hook is about 1 mm.

5. If you can not set the correct position with procedure no.4, then Thread catcher device should be adjusted.

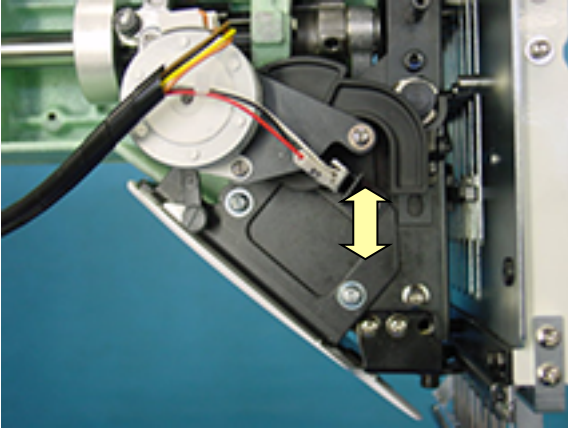

6. Check up with thread trimmer function.

7. Assemble lower front cover to terminate this procedure.

1. Referring to [3-2-1 Exchange of crank], remove Font cover

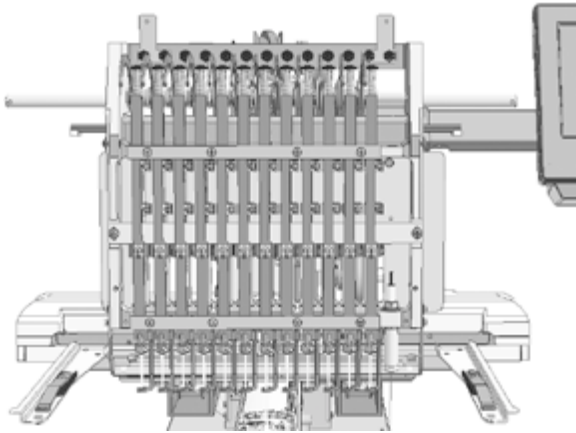

2. Remove thread holder ass'y.

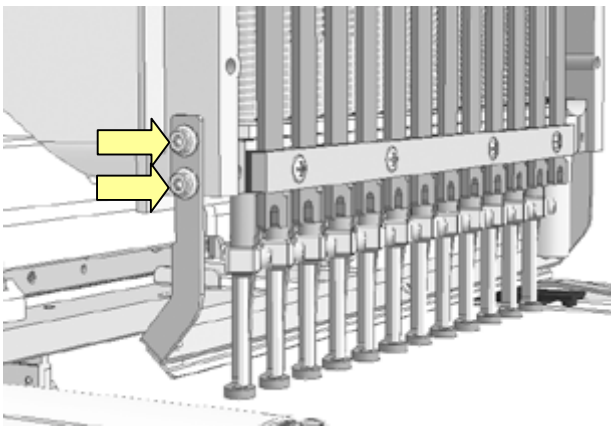

3. Remove holder (lower).

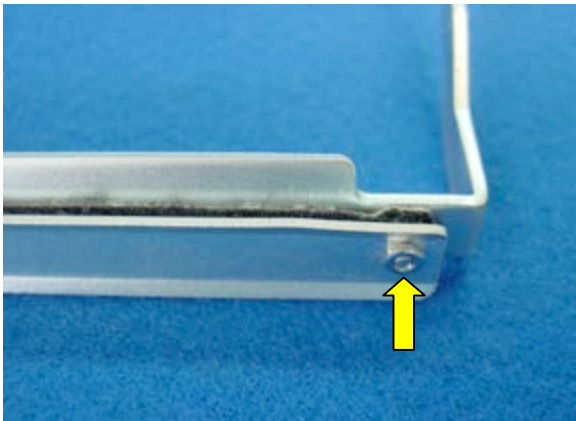

4. Exchange the majic-tape.



5. Assemble holder (lower).

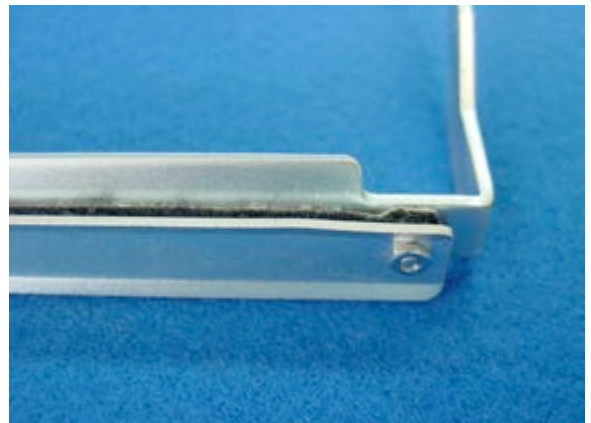

6. Install holder ass'y to moving head in reverse order to finish.

Please refer to [3-3-13 Adjustment of thread holder].

Fixing of needle bar change unit

3-4-1

1. Place needle bar change unit assembly.
please set positioning hole on unit assembly to positioning pin.
Insert arrow marked screws temporary. Connect cable.

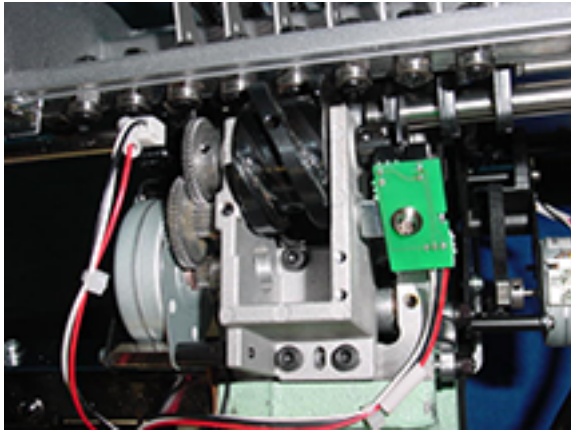

2. Turn slit collar and adjust angle that groove of slit collar should be located same position of sensor.
Referring to 4-2-3 [Adjustment of stop position of needle bar change unit]

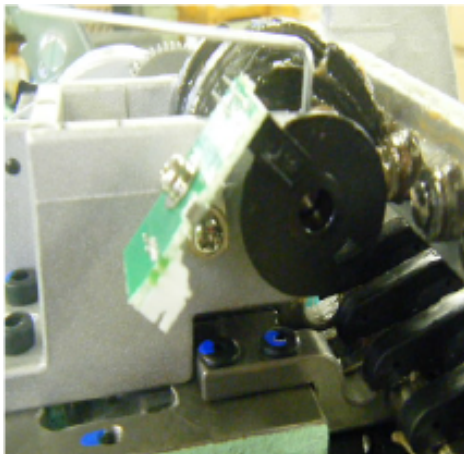

Confirm that the slit does not touch the sensor.

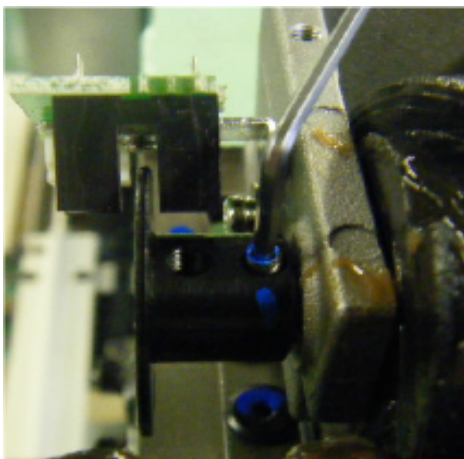

3. Turn drive gear B by finger and set needle bar to no.4.

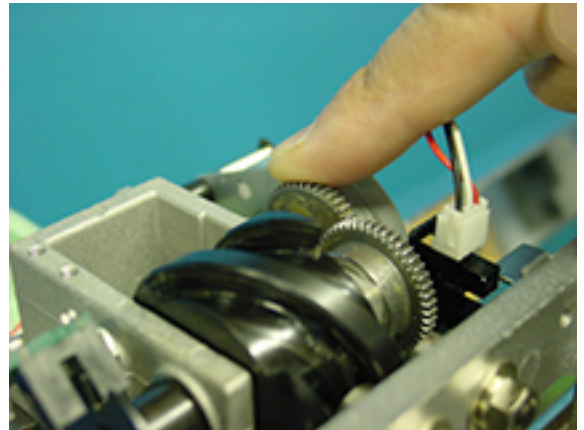

4. Bring pressure foot down. (Either way mentioned below)



- (1) press  on control box.

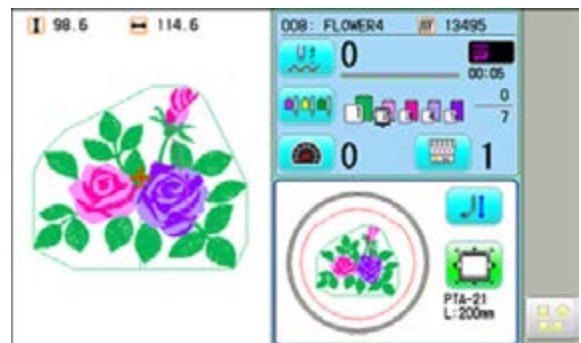

- (2) Turn gear with finger.

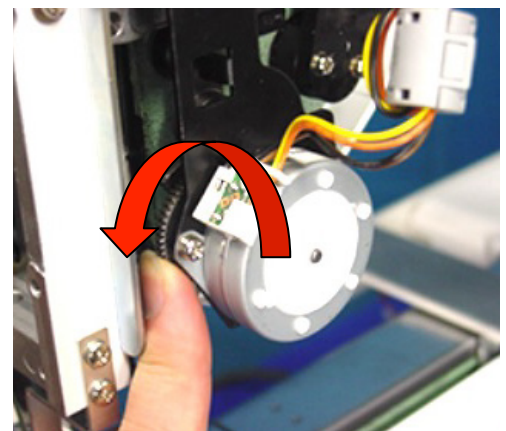

5. Bring needle down, turn upper shaft to set near to [L point].

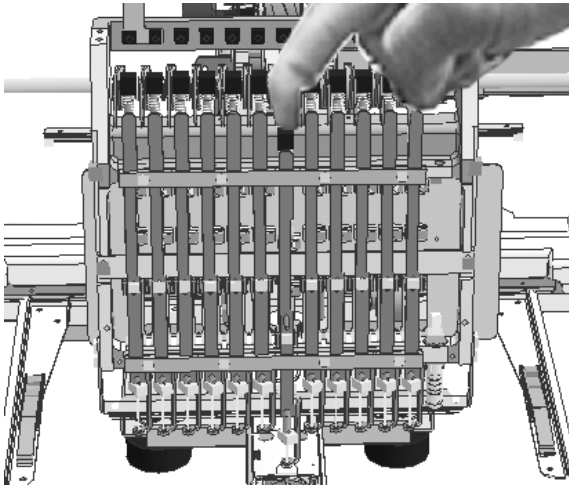

6. Adjust position of unit assembly so that needle comes to center against needle hole on needle plate.

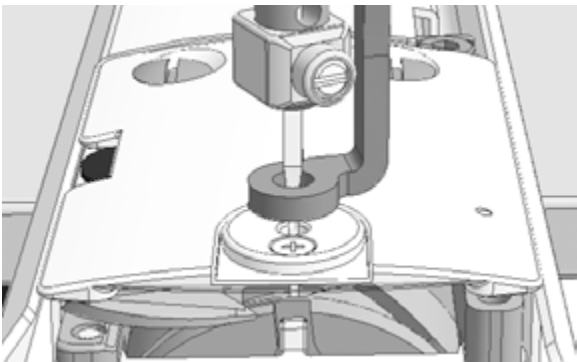
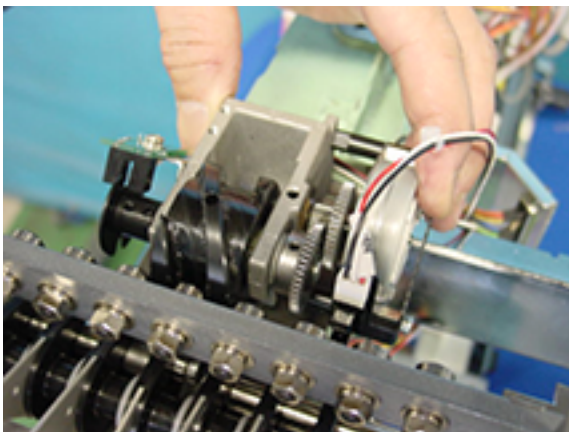

7. Return other parts to previous.

For adjustment of fixing of each unit, please refer to process to adjust fixing of each unit.

8. Please check and adjust the following timing to finish.

- (1) Shuttle hook timing
- (2) Needle height
- (3) pressure foot

Adjustment of rotary hook timing

3-5-1

1. Remove needle plate.

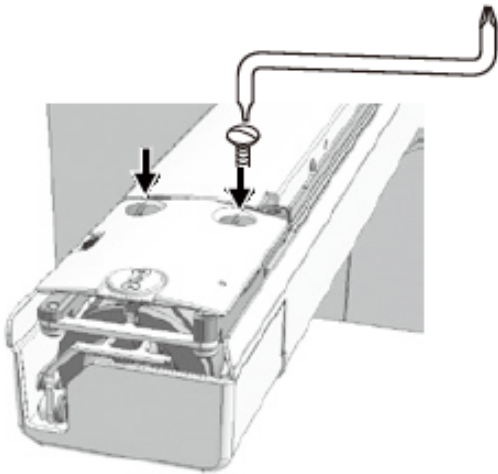

2. Bring pressure foot down. (Either way mentioned below)



(1)press on control box.

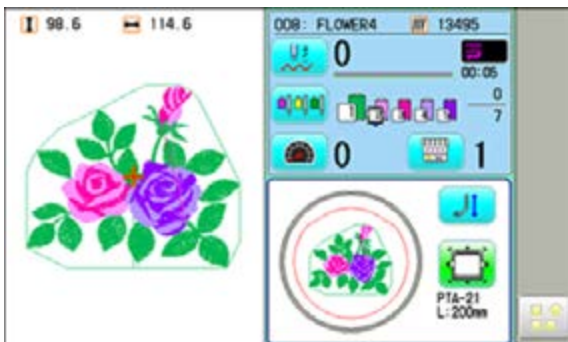

(2)Turn gear with finger.

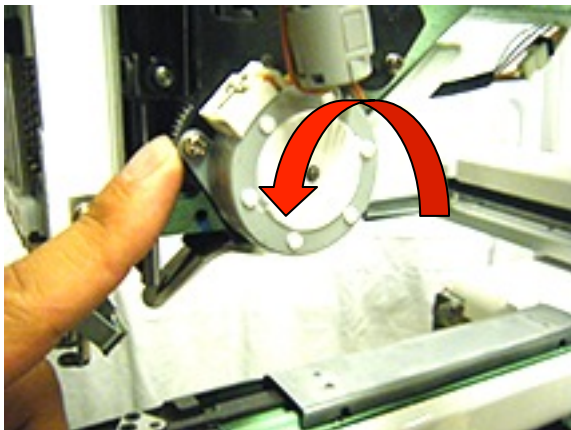

3. Tighten screw on rotary hook. (3 places)



4. Bring needle bar down by finger.

Also you can move down the needle bar by maintenance mode through menu of control box.

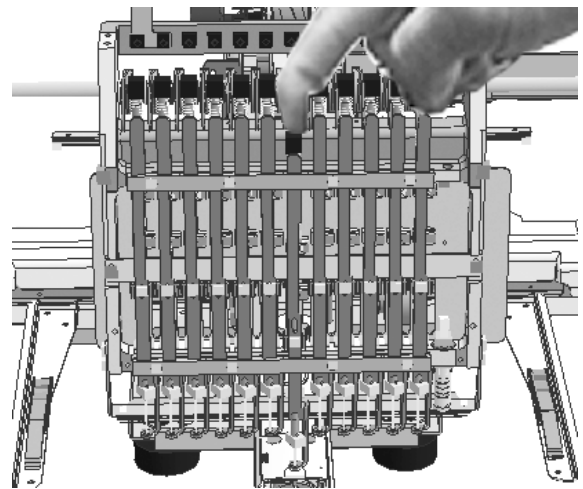

5. Turn upper shaft and set dial disc to [25 degrees].

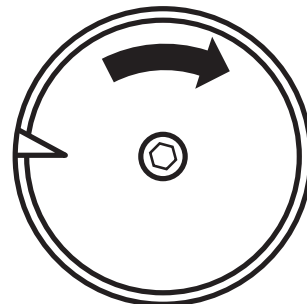

Adjustment of rotary hook timing

6. Adjust rotary hook timing.

This procedure is preconditioned to use needle type [DB-K5] in which contains with our standard accessory.

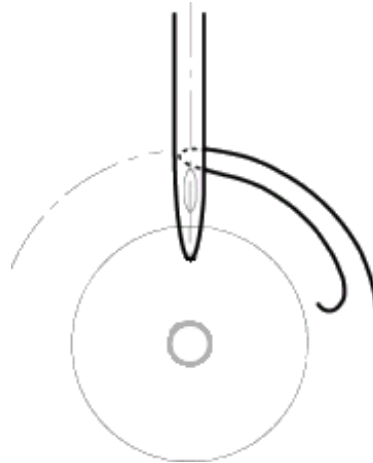

At this moment, clearance between needle and rotary hook should be [0.1-0.2mm].

Check and adjust with 1st, 6th and 12th needle and tighten screws.

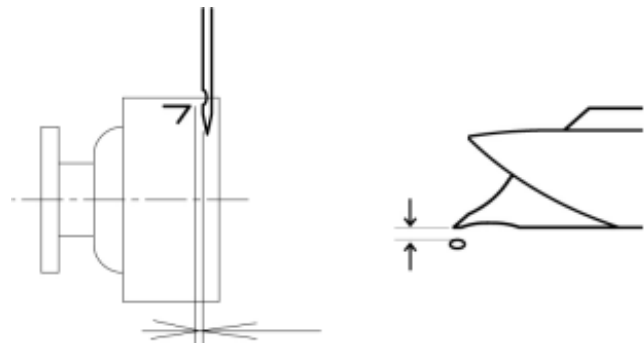

0.1-0.2mm

7. For making sure, check position of retainer on bobbin case holder.

Please refer to [3-5-2 Adjustment of retainer on rotary hook] for adjusting value and follow it.

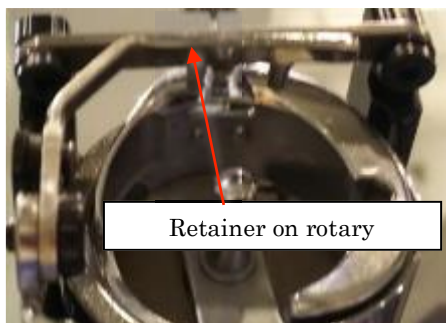

8. Adjustment has finished.

Adjustment of retainer on rotary hook

3-5-2

1. Loosen screw to the extent that retainer on bobbin case holder moves. (2pcs)

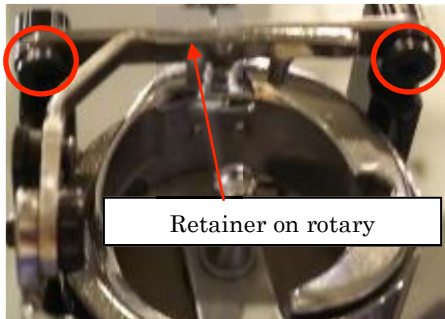

2. Adjust position back and forth, left and right.
Space has to be [0.8mm] and the position right and left is center of the needle.

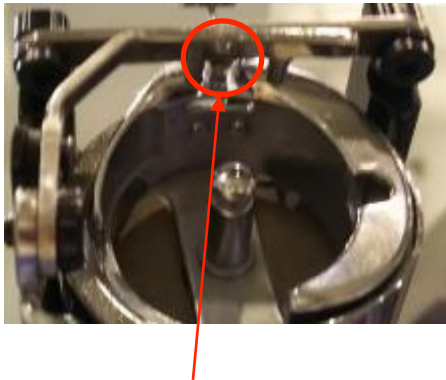

Needle center and retainer center should come to same position

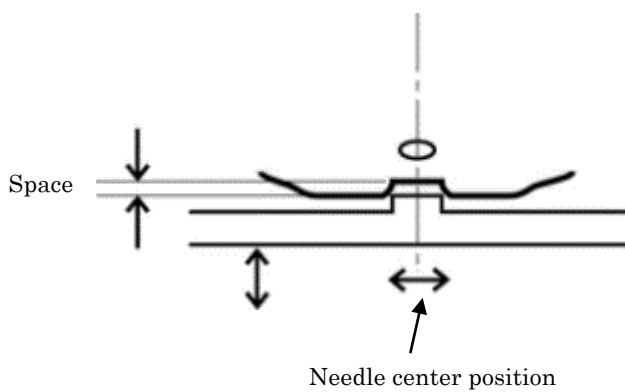

3. Adjustment has finished.

Assemble the arm ass'y

3-6-1

1. Assemble the arm ass'y tentatively.



2. Hold arm to backward and tighten only hithermost screw.

<Caution>

Make sure that there is clearance between arm and body.

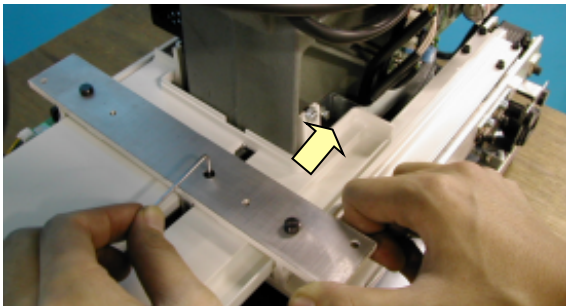

3. Hold the left side of arm to body and tighten screw.



4. Hold the right side of arm to arrow pointed direction at below picture and tighten screw.

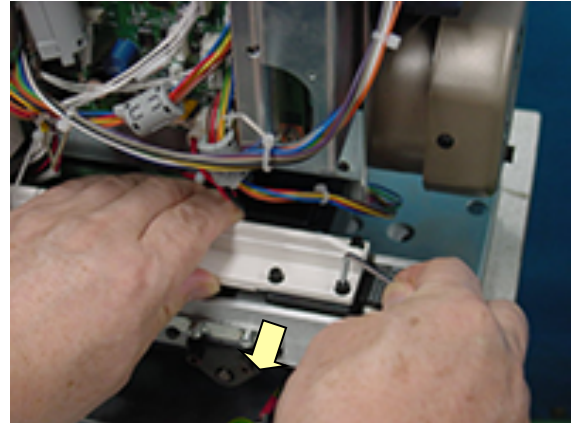

5. Assemble detecting plate.

Make sure that detecting plate is mount perpendicular and parallel to the arm.

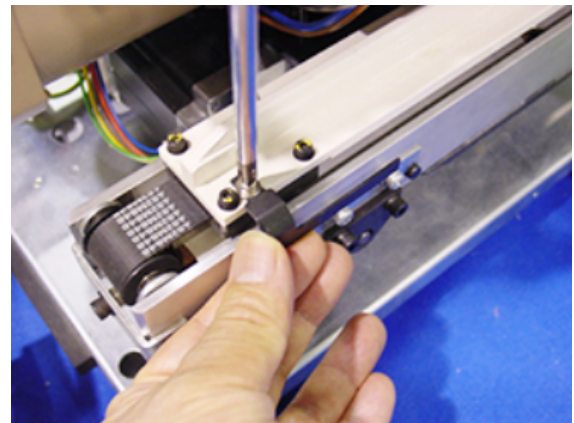

Assemble the arm ass'y

3-6-1

6. Check of interference between detecting plate and two sensors or connector of sensor board.

A part of sensor

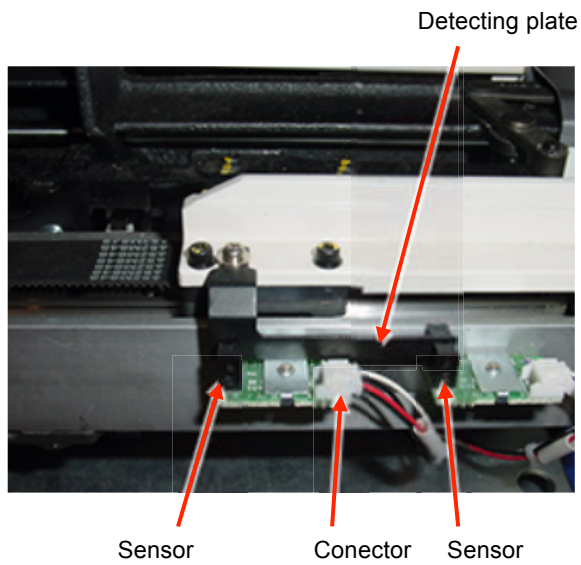

A part of conector

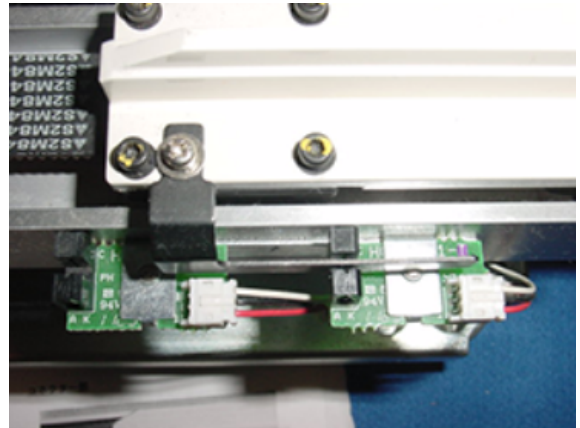

7. Adjust by bending detecting plate by hand if you find any interference with sensor or connector.

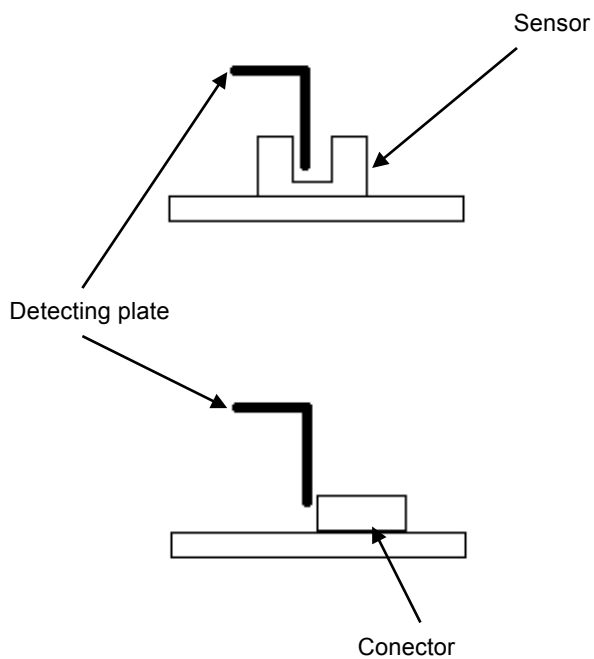

8. Finish this process.

1. Referring to [3-2-1 Exchange of crank],
Remove
Thread stand and outer covers.

2. Referring to [3-7-4 Exchange of Y carriage
belt],
Remove arm.

11. Remove Bobbin winder, power supply.
Screw 4 pcs

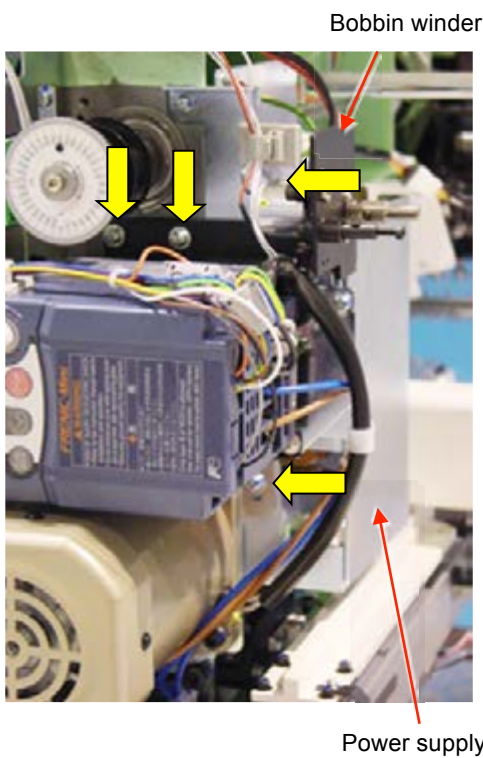

4. Disconnect cable from sensor board.

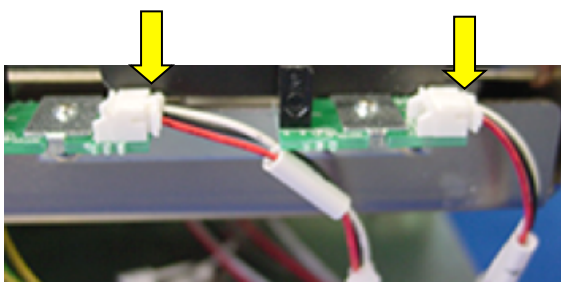

5. Loosen the screw for coupling of the Y carriage.

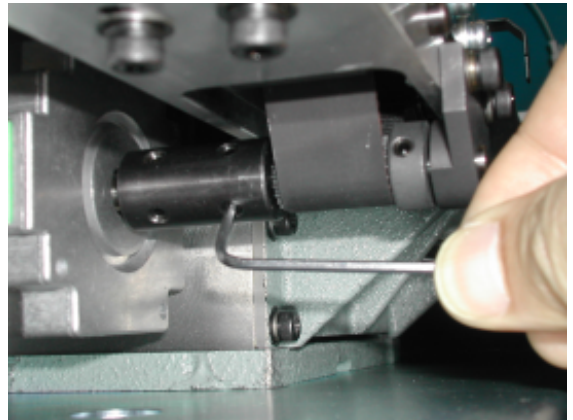

6. Remove the screw of Y carriage bracket (left).

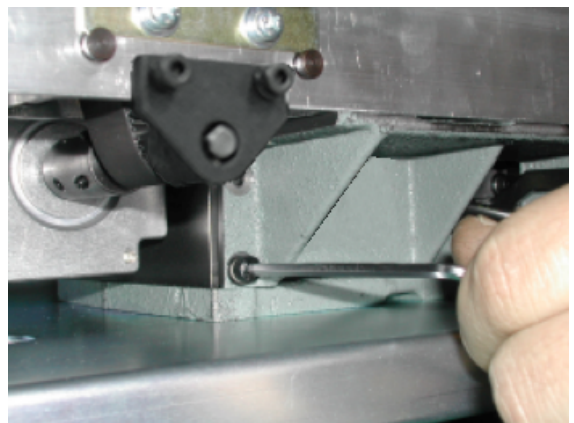

7. Remove the Y carriage.

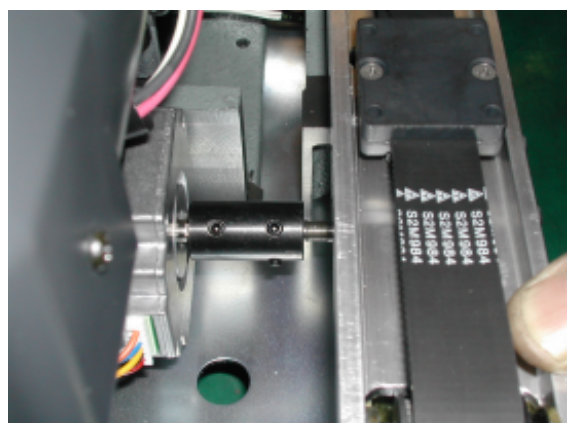

8. Remove thread cutting driver.

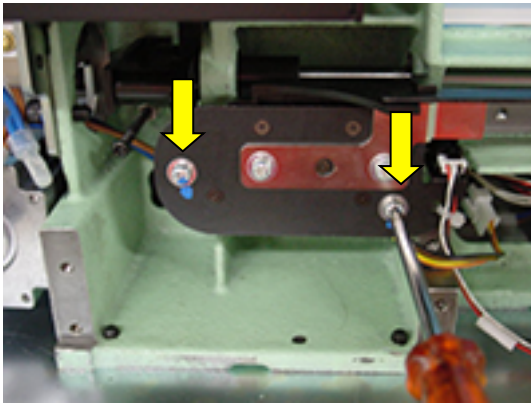

9. Disconnect cable.

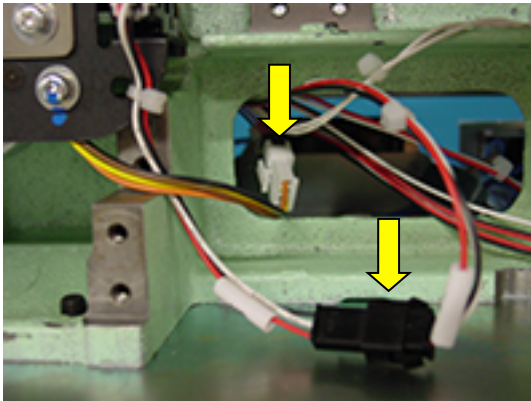

10. Remove Pulse motor.

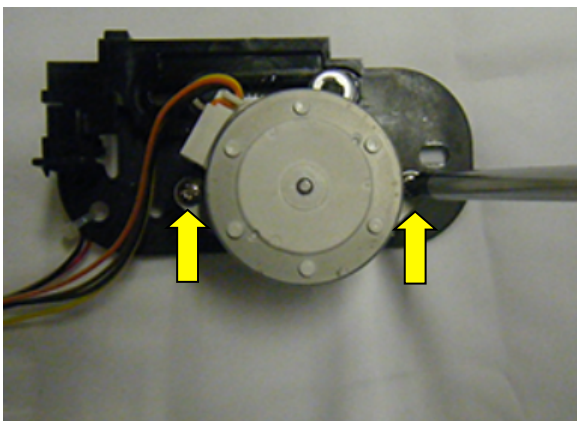

12. Remove Drive gear.



13. Install Drive gear on good Pulse motor
Position of Drive gear is space from Pulse motor.

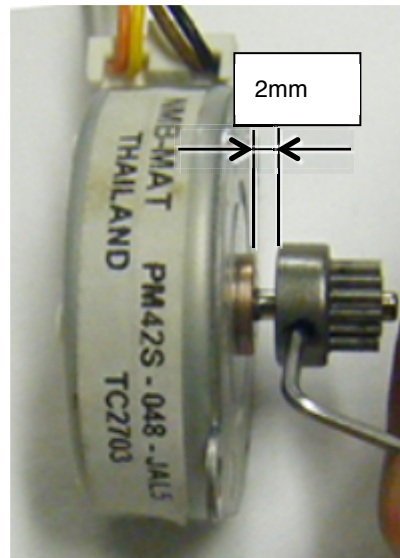

13. Place parts back in accordance with manual.

14. Check and adjust position of moving knife to finish.

Please refer to respective adjustment.

Exchange of bobbin thread holder

1. By referring the “3-3-4 check of needle position”, open 1.
By referring the “3-3-4 check of needle position”, open the hole into the seal of needle plate.

*Note the number of needle.

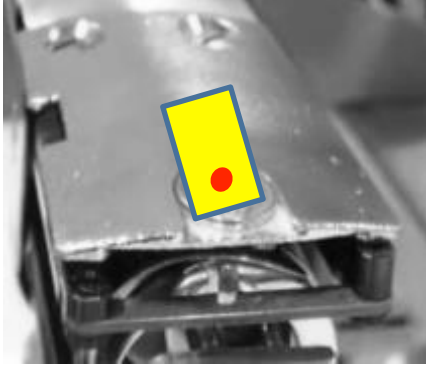

2. Remove needle plate. (Fixing screws 2pcs)

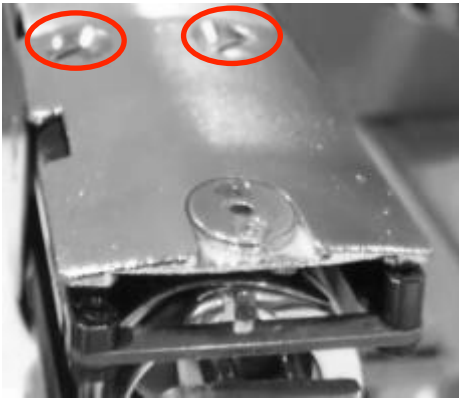

3. Remove the thread cut unit.

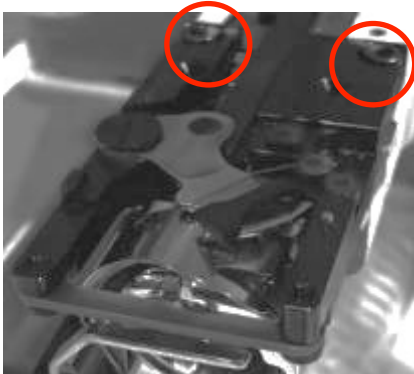

4. Remove the bobbin thread holder fixing screw.



5. Remove and exchange the bobbin thread holder to good one.

6. Attach the thread cut unit.

* Adjust the needle point should be match with the hole of seal.

7. By Referring “3-6-10 Adjustment of bobbin thread holder”, finalize the work by checking and adjustment for bobbin thread out.

Exchange of moving knife

1. By referring the “3-3-4 check of needle position”, open the hole into the seal of needle plate.

*Note the number of the needle.

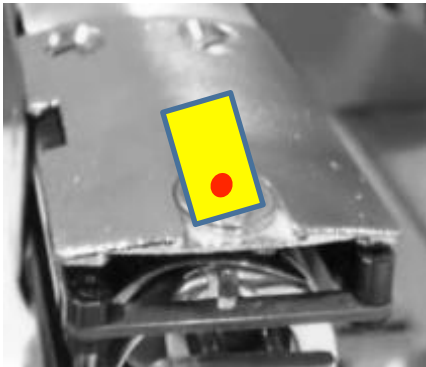

2. Remove needle plate. (Fixing screws 2pcs)

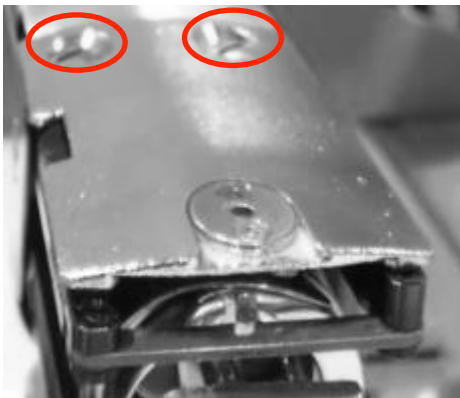

3. Remove the thread cut unit.

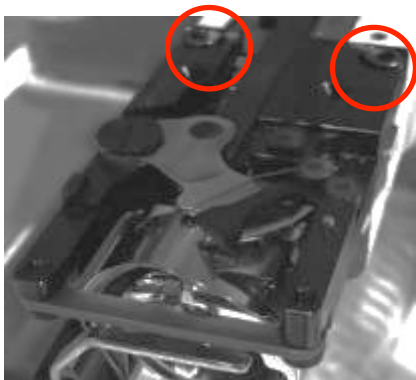

4. Remove the screw of knife shaft.



5. Remove the knife shaft.

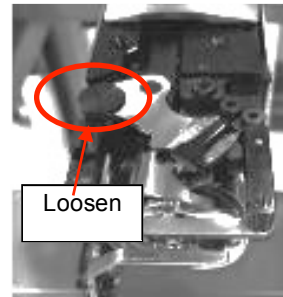

6. Exchange moving knife.

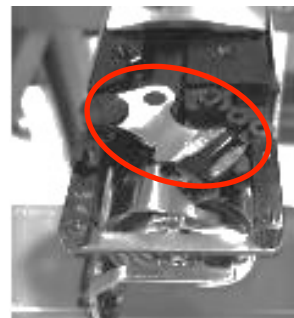

7. Fix moving knife with knife shaft and screw

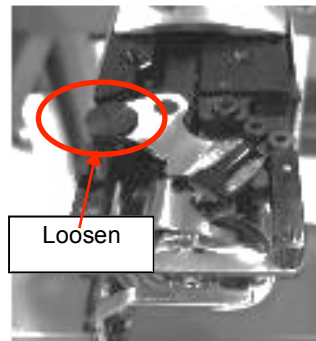

8. Attach the thread cut unit.

* Adjust the hole of seal should be match with needle point.

9. Referring to [3-6-8 Adjustment of moving knife and fixed knife], check how well thread is cut and adjust, then finish this process.

1. Remove needle plate. (Fixing screws 2pcs)

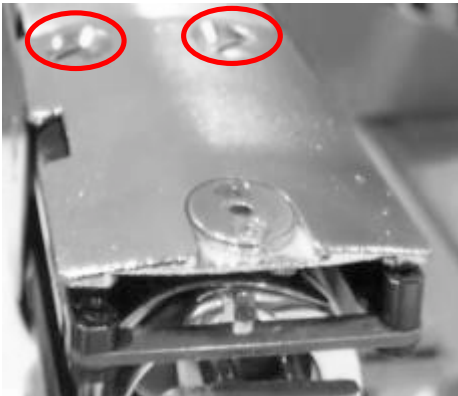

2. Remove fixed knife and exchange to good one.

At this time, place the sim ring under the hole on the left side.

Tighten fixed knife pushing to backward as full as possible.

Make sure the fixed knife is in the same position as Shown in fig.



Sim ring

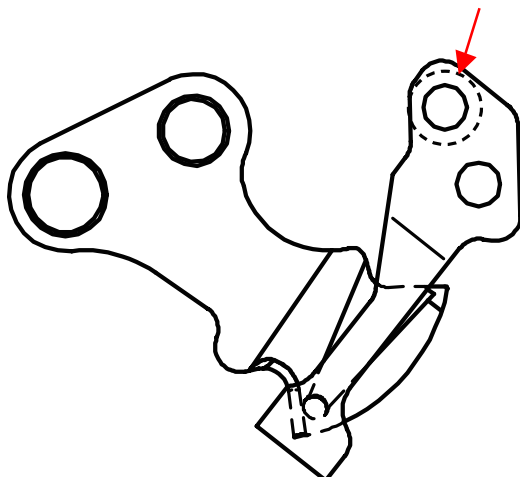

3. Attach the needle plate.

4. Referring to [3-6-8 Adjustment of moving knife and fixed knife], check how well thread is cut and adjust, then finish this process.

Adjustment of moving knife and fixed knife

3-6-8

1. Remove needle plate. (Fixing screws 2pcs)

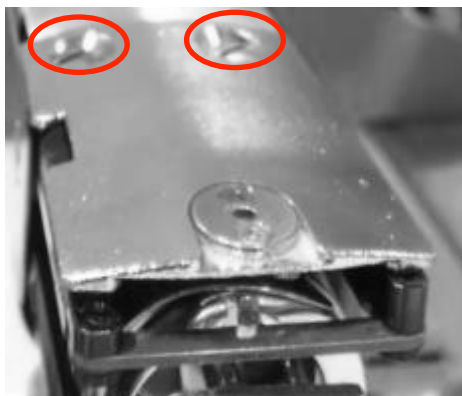

2. Open the keeper cover.

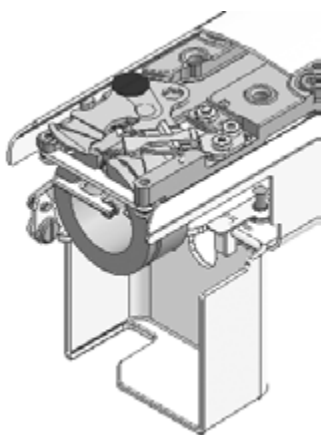

3. Adjust slant of fixed knife with [upper adjustment screw] and [lower adjustment screw] that fix fixed knife.

<Note>

Rub these screws together to the extent that you don't feel resistance.

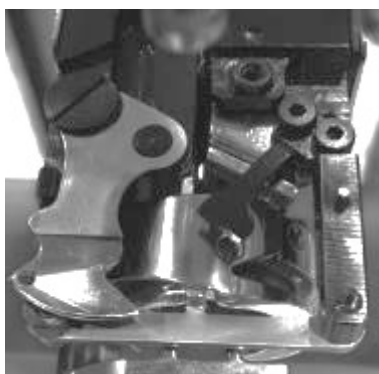

<Spanner> 5.5mm

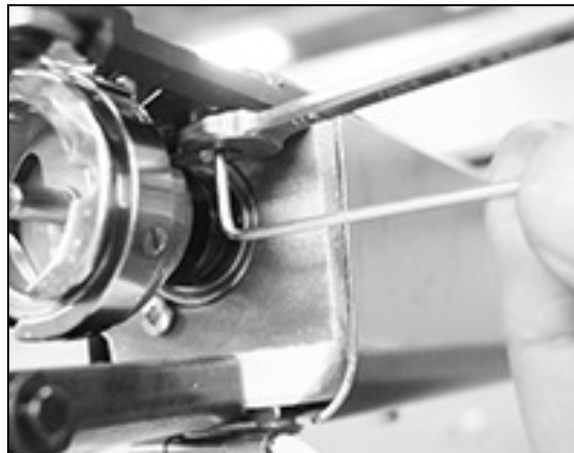

4. Cut thread and check how well it is cut.

Use two polyester threads for checking.



Threads

5. Check several times and if no mistakes are found, finish this process.

Adjustment of position of moving knife

1. Remove Needle plate and Cover (front).

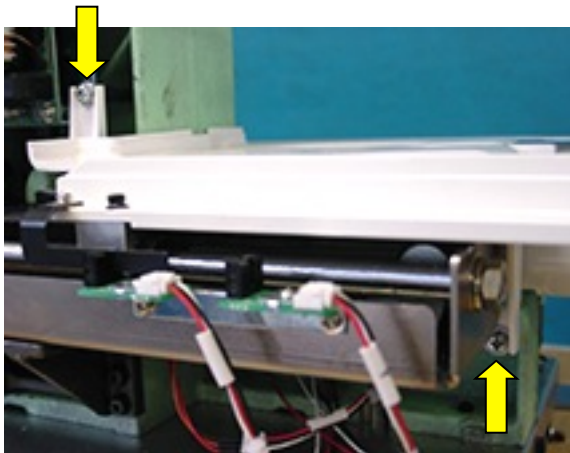

2. Enter maintenance mode in reference to [9-1 How to enter maintenance mode]

3. Press **Machine Test**.

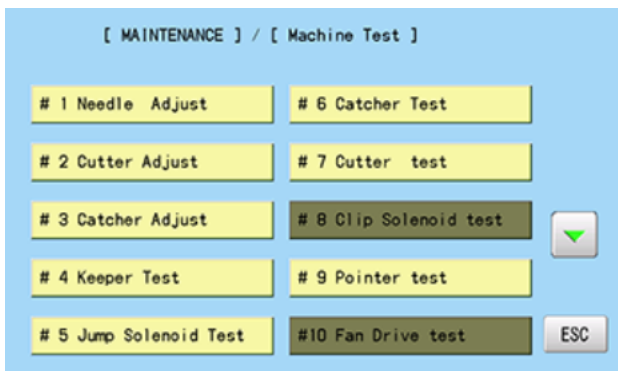

4. Press **#2 Cutter Adjust**.

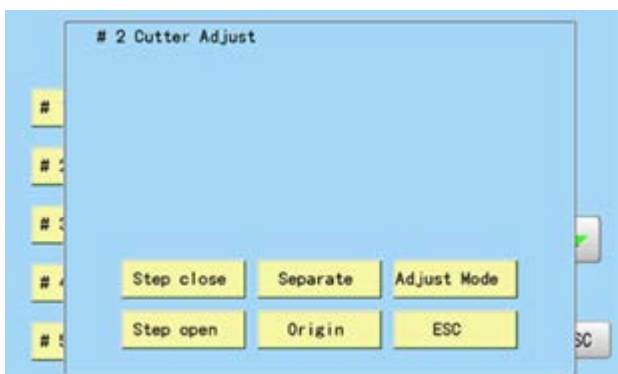

5. Press **Separate**, then the Moving knife will be opened.

Please confirm that the tip of Moving knife is located at center of Rotary hook retainer.

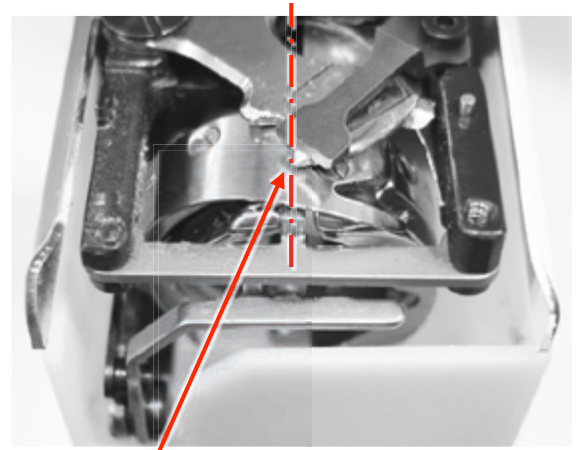

Tip of moving knife

6. In case the tip of moving knife is not in the right position, loosen screw on Thread cutting rod, then adjust position of the Moving knife with turning Eccentric pin.

Tighten screws.

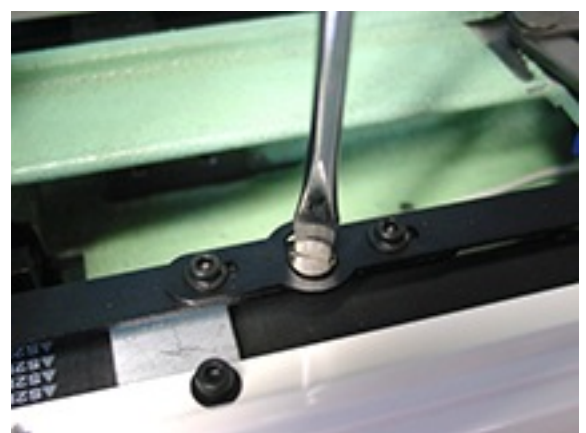

7. Press **[Origin]**, then the Moving knife will be closed.

Please confirm that the Moving knife is located as drawing below.

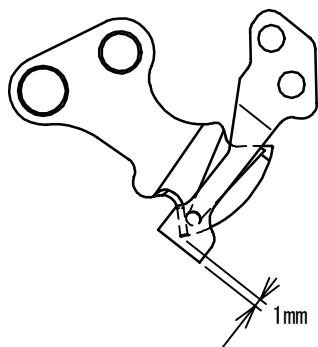
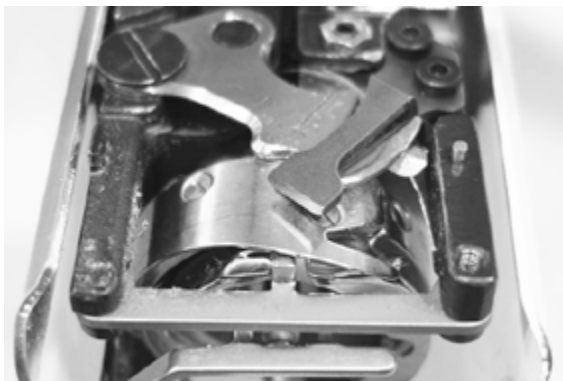

Make sure that the tip of the moving knife is positioned as shown in the figure with respect to the fixed knife.

8. Press **[Separate]** and **[Origin]** by turns to confirm that the Moving knife is closed in the right position.

Press **[ESC]** to finish 「Maintenance mode」 .

9. If necessary, please refer to [3-6-8 Adjustment of moving knife and fixed knife] and check how well thread is cut, then finish.

Adjustment of bobbin thread holder

3-6-10

1. Remove needle plate.

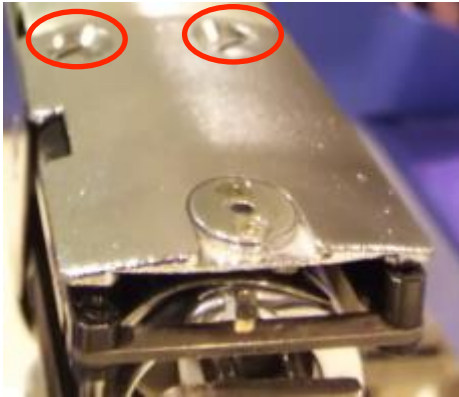

2. Remove keeper cover. (Fixing screws 2pcs)



3. Close moving knife like putting bobbin thread between moving knife and bobbin thread holder.



4. Adjust height of bobbin thread holder with adjusting screw.

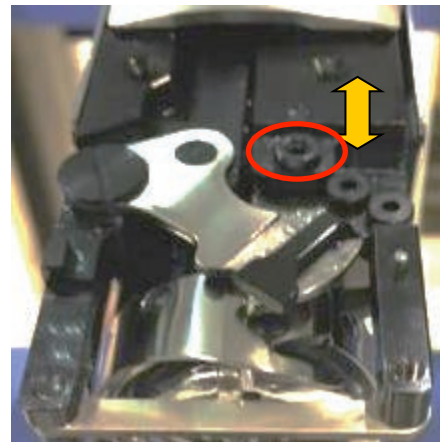

5. Pull bobbin thread toward arrow mark and see that bobbin thread comes off with tensile gauge [5 - 8g].

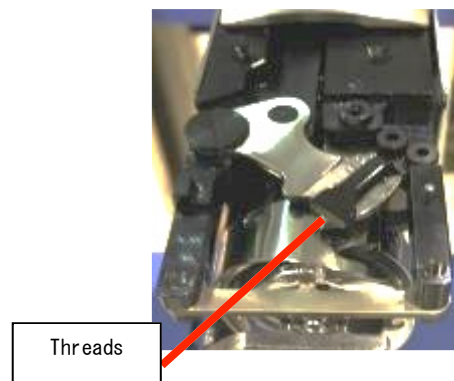

6. Tighten lock nut. (Don't move adjusting screw)
<Spanner> 5.5mm



7. Check several times and if OK, finish this process.

Exchange of keeper solenoid

1. Remove connector for keeper solenoid.

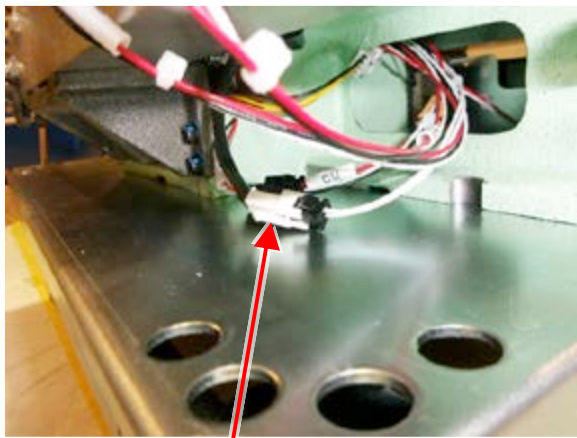
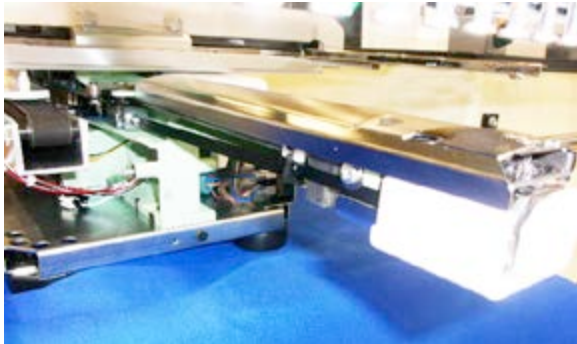

Connector

2. Remove screw for keeper rod and stopper.

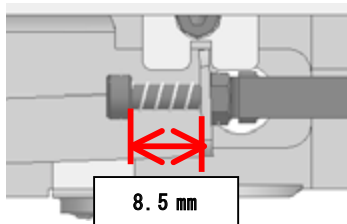

8.5 mm

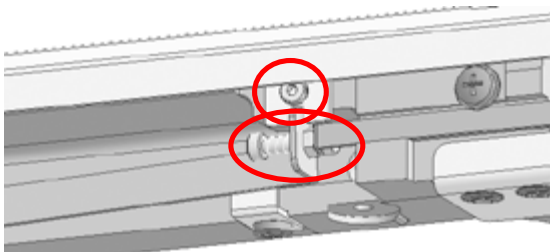

3. Remove keeper solenoid ass'y.

(Fixed screw 2pcs.)

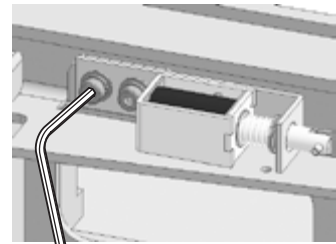

4. Exchange keeper solenoid. (Fixing screw 2pcs)

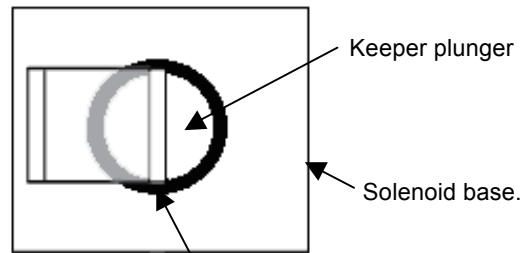

Keeper plunger

Solenoid base.

Clearance between keeper plunger and solenoid base should be kept as much as equally.

5. Put keeper solenoid ass'y in previous position then adjustment of position of keeper finished.

Referring to [3-6-9 Adjustment of position of keeper].

<Caution>

When installing the bed cover (lower), make sure it does not touch the connecting plate.

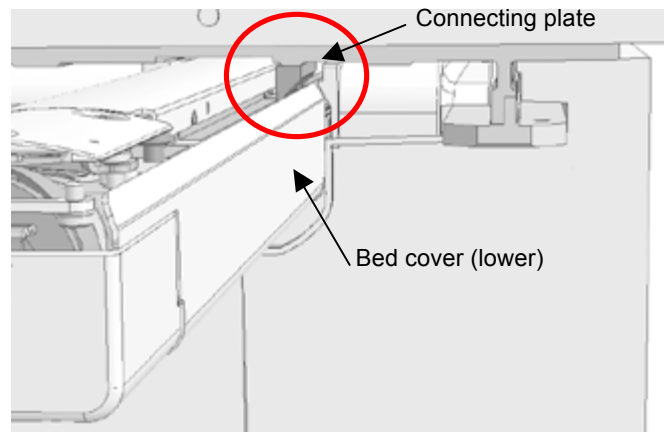

Connecting plate

Bed cover (lower)

Adjustment of position of keeper

3-6-12

1. Loosen screw for stopper. (Fixing 1 screw)

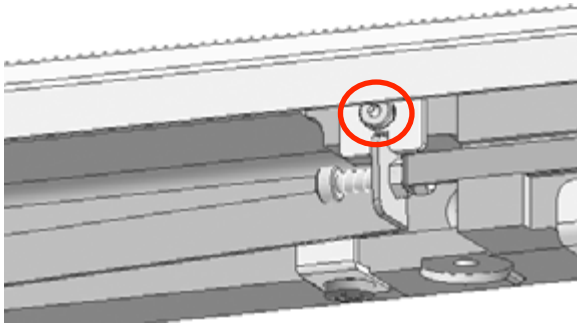

2. Pull the stopper backward and adjust the keeper waiting position.

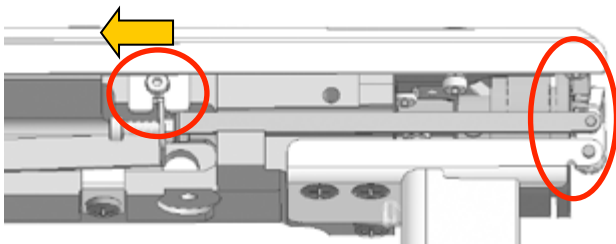

3. Adjust opening between tip of keeper and lower thread bobbin should be 0.5 mm.

Use a keeper positioning jig (EJIG-R40) and adjust opening between tip of keeper and lower thread bobbin should be 0.5 mm.

At this position, retighten the screw for stopper.



<View from right>

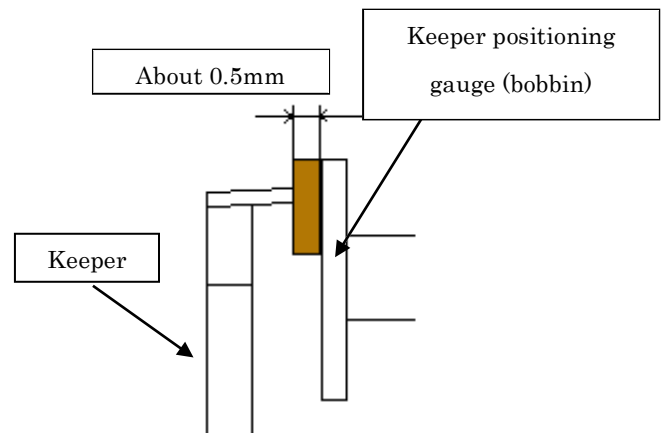

4. Perform sewing test and verify upper thread should not tangled with the keeper at waiting position.

5. Adjustment has finished.

Adjustment of X carriage belt tension

3-7-1

1. Remove frame base.

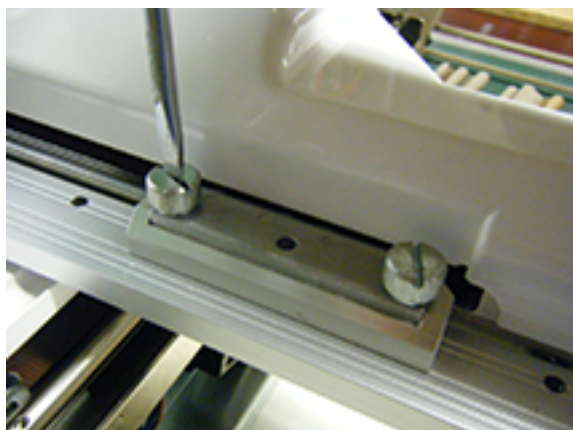

2. Disconnect X carriage cable.



3. Remove X carriage. (Screw : 2 pcs)

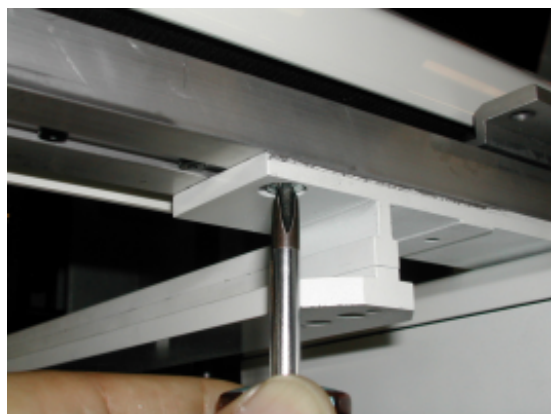

4. Remove X carriage cover. (Screw : 2 pcs)



5. Remove sensor bracket.



6. Loosen fixing screw for tension pulley bracket slightly.
(front side)



Adjustment of X carriage belt tension

3-7-1

7. Loosen fixing screw for tension pulley bracket slightly.
(rear side)

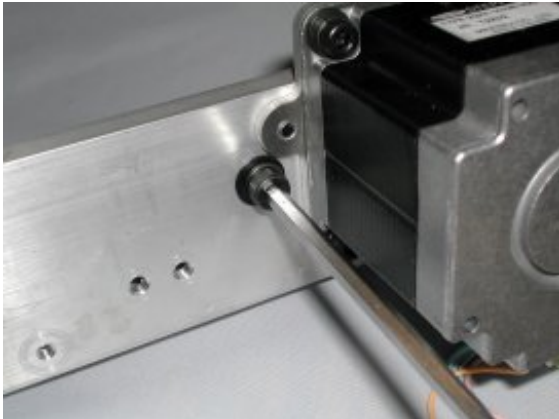

8. Adjust belt tension.
Use push and pull gauge.

<Adjustment value>

[500cN] at the status of which both belt is touch.

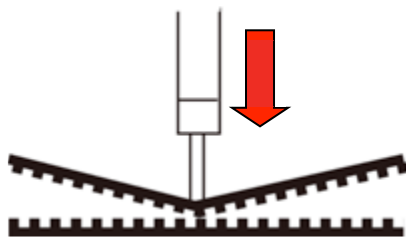
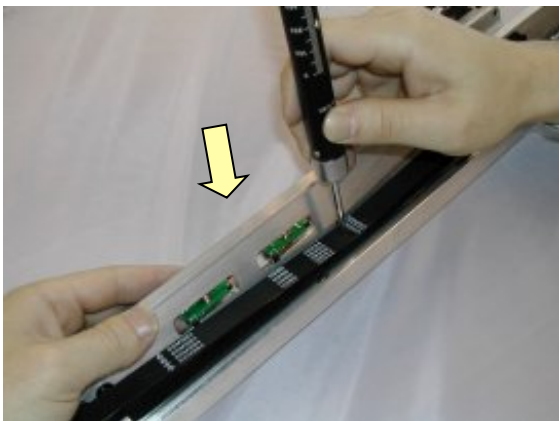

<Note> Slide connecting plate to right as full as possible.

Gauge in the middle of idler pulley and tension pulley.

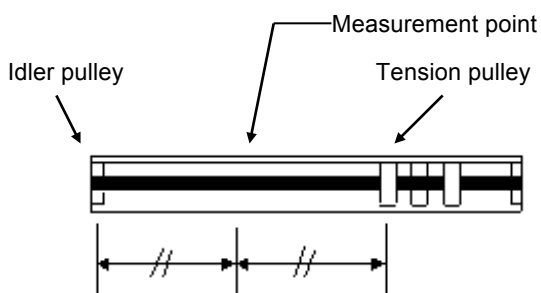

Adjustment, tighten fixing screw for tension pulley bracket.

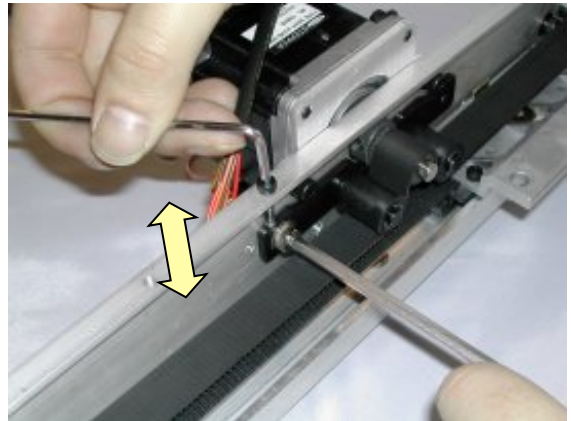

9. Tighten fixing screw for tension pulley bracket. (front side)

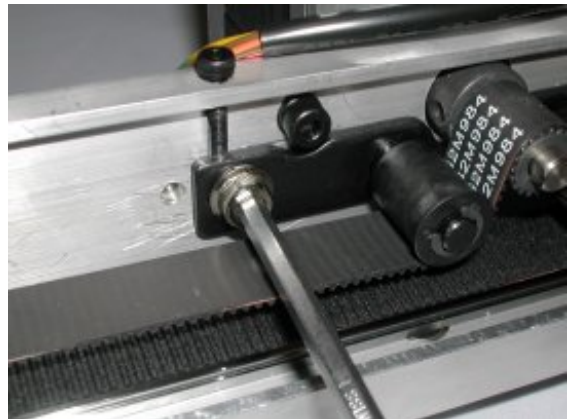

10. Tighten fixing screw for tension pulley bracket. (rear side)



11. Return things back to previous places in reverse order.

Exchange of X carriage belt

3-7-2

1. Remove frame base.

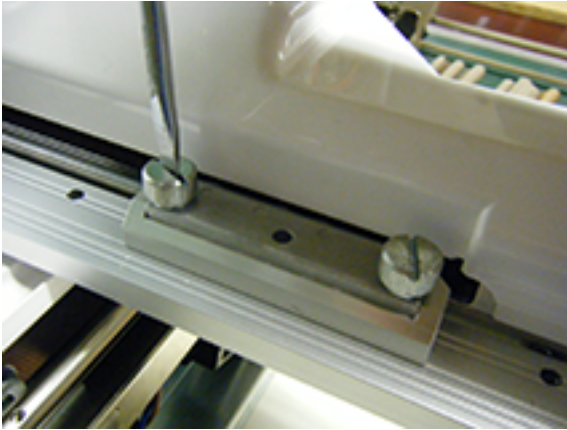

2. Disconnect X carriage cable.



3. Remove X carriage.

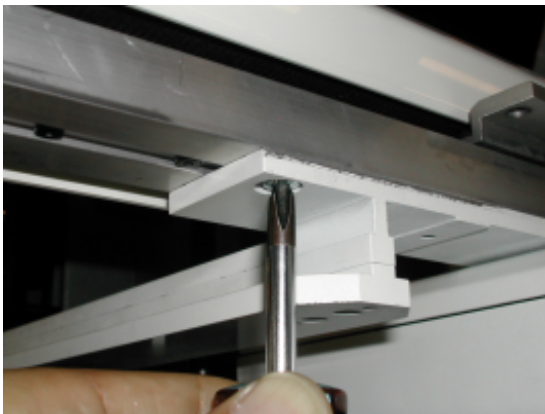

4. Remove X carriage cover.



5. Remove sensor bracket.



6. Loosen screw for tension.

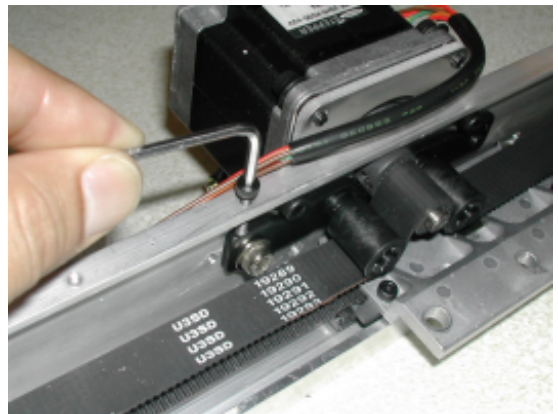

Exchange of X carriage belt

3-7-2

7. Remove the screw which fixes tension bracket.

Remove the plate nut located other side.

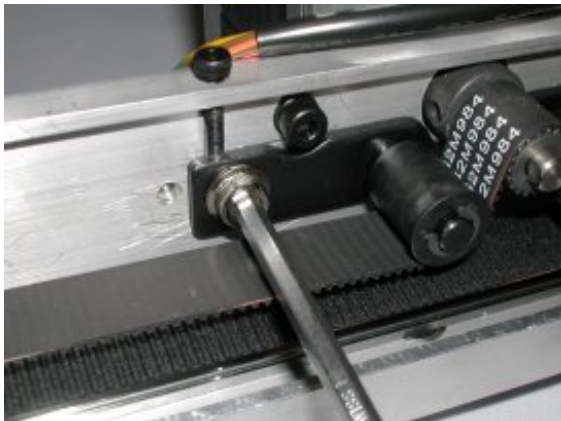

8. Loosen screw (rear) slightly to the extent that tension-bracket moves.

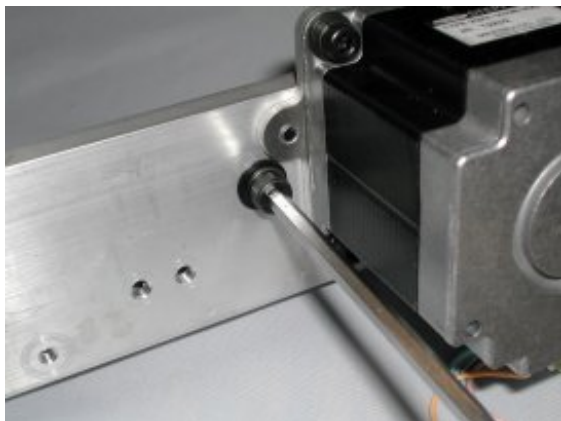

9. Remove belt from motor pulley.

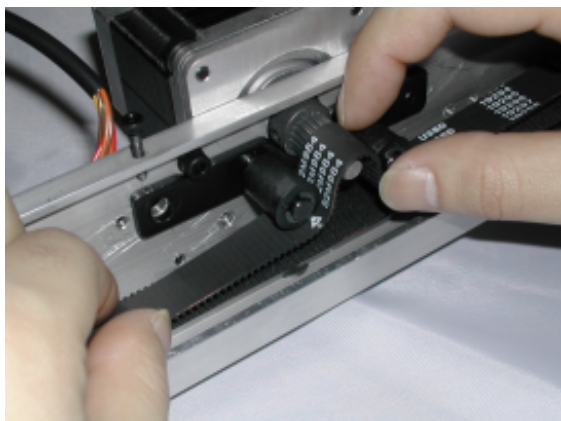

10. Remove connecting plate.

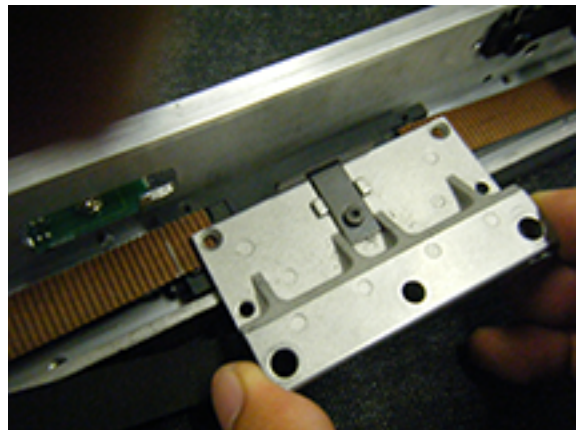
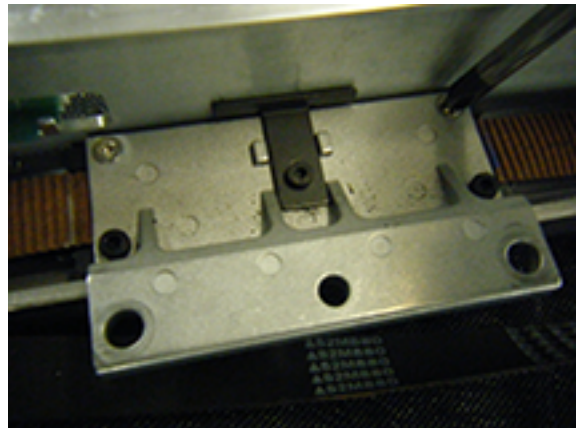

11. Exchange belt to good one.

<Important>

Exchange it so as not to break groove and convex on belt of connecting plate.



12. Adjust the position of belt.

Space between edge of X base and belt is [10mm].

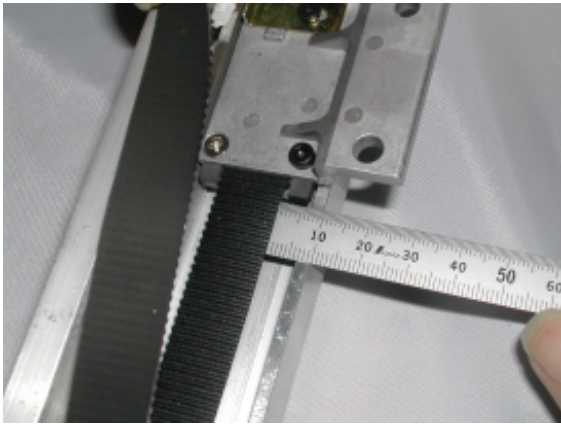

13. Referring to [3-7-1 Adjustment of X carriage belt tension], adjust tension of belt.

14. Put removed screw and nut plate.

15. Return X carriage assembly and frame base to previous places to finish.

Adjustment of Y carriage belt tension

3-7-3

1. Referring to [2-1 Removal of outer covers], remove outer covers.
2. Remove cover (front), referring to [3-6-1 Assemble the arm ass'y], remove arm.
3. Loosen lock nut for tension adjustment screw.
<Spanner> 7mm

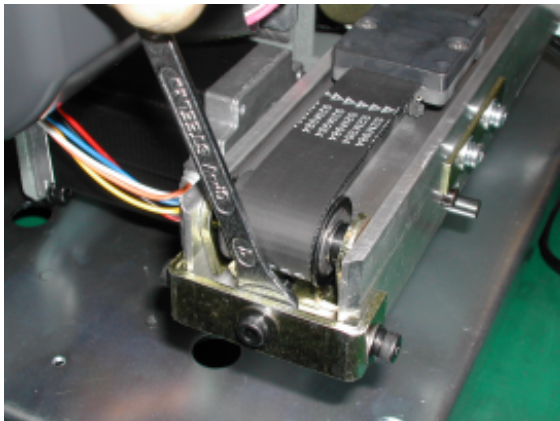

4. Loosen tension screw so as to move tension.

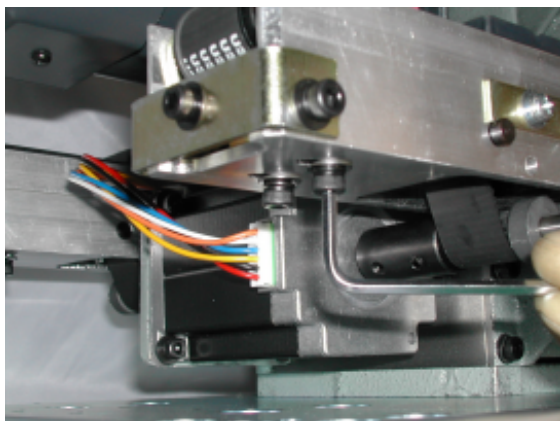

5. Adjust belt tension, to use belt tension gauge.
Use push and pull gauge.

<Adjustment value>

Adjusted to be [500cN] at state that Belt attaches to Rail.

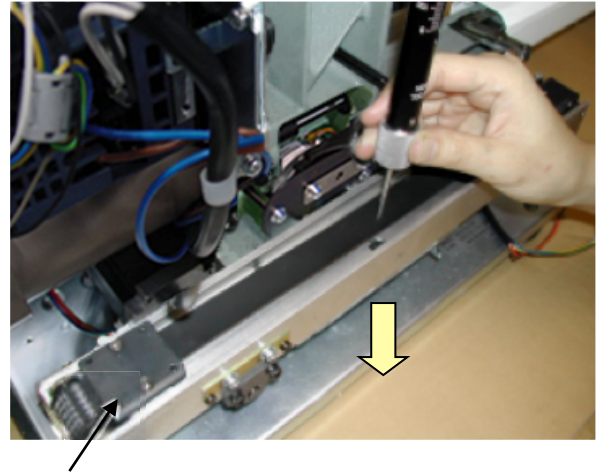

Push belt holding plate backward as full as possible.

Gauge in the middle of idler pulley.

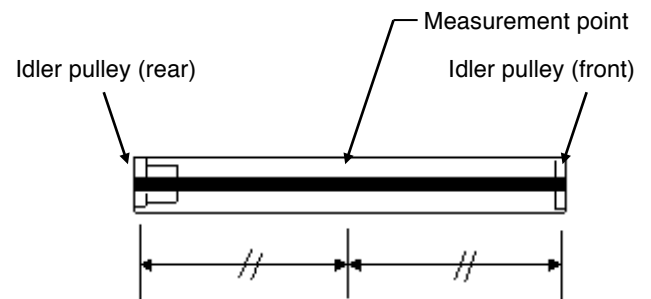

Adjust with screw.

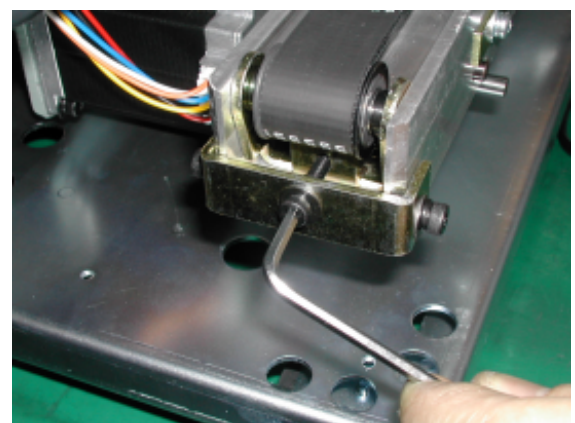

6. Tighten screw on tension.

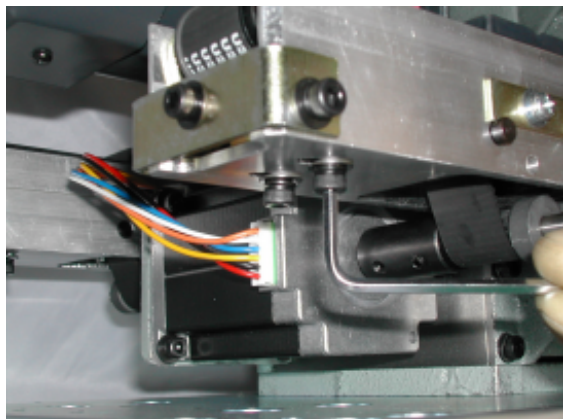

7. Tighten lock nut for tension adjustment screw.

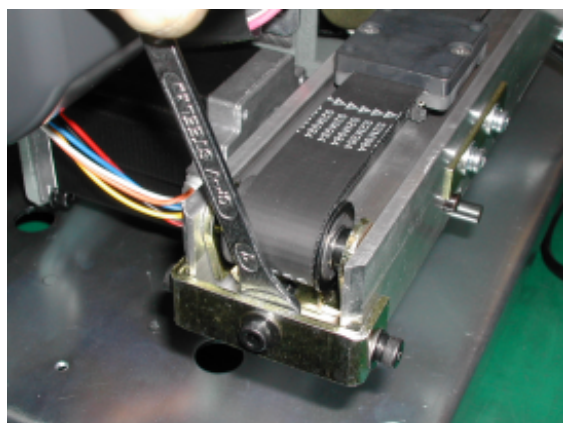

8. Put other removed parts back to finish.

Exchange of Y carriage belt

1. Referring to [2-1 Removal of outer covers], remove outer covers.
2. Remove cover (front), referring to [3-6-1 Assemble the arm ass'y], remove arm.
3. Loosen lock nut for tension adjustment screw.
<Spanner> 7mm

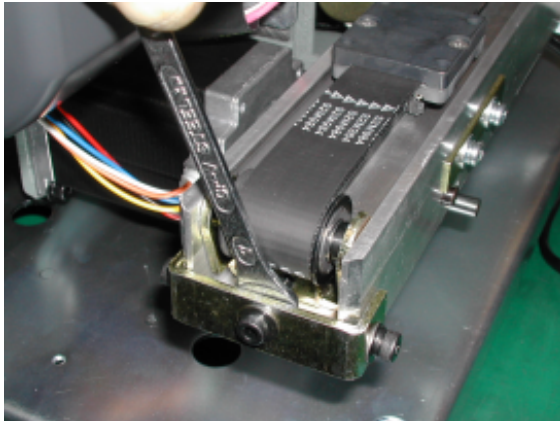

4. Loosen tension screw so as to move tension.

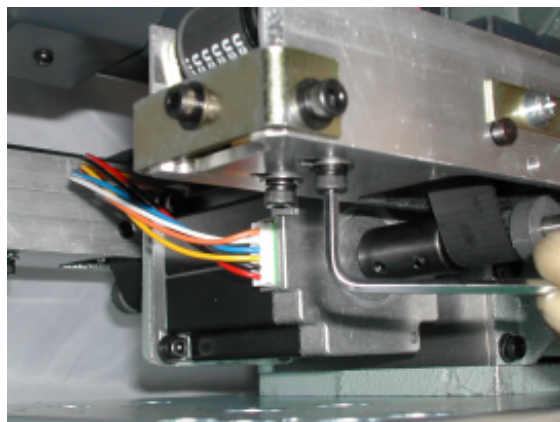

5. Loosen screw for tension.



6. Remove belt holding plate.

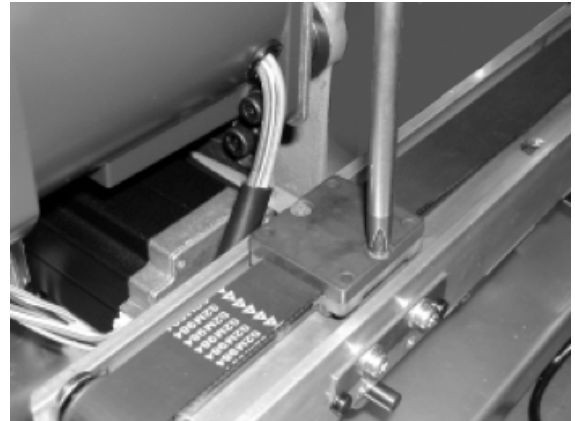

7. Exchange belt.



8. Set belt to belt groove of guide frame base.

<Important>Exchange it so as not to break belt tooth and convex on belt.



Do not put belt tooth on the innermost groove of the connecting plate.

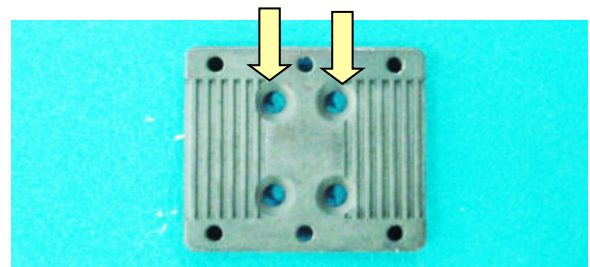

9. Fix belt holding plate.

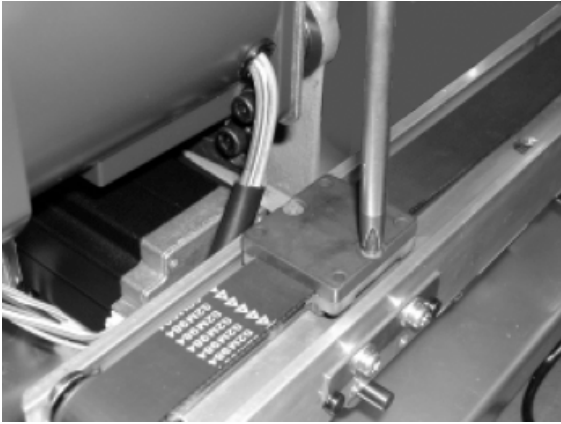

10. Referring to [3-7-3 Adjustment of Y carriage belt tension], adjust tension of Y belt.

11. Put other removed parts back to finish.

Adjustment of timing belt tension

3-8-1

1. Remove bobbin winder.

2. Remove Bobbin winder, power supply.

Screw 4 pcs

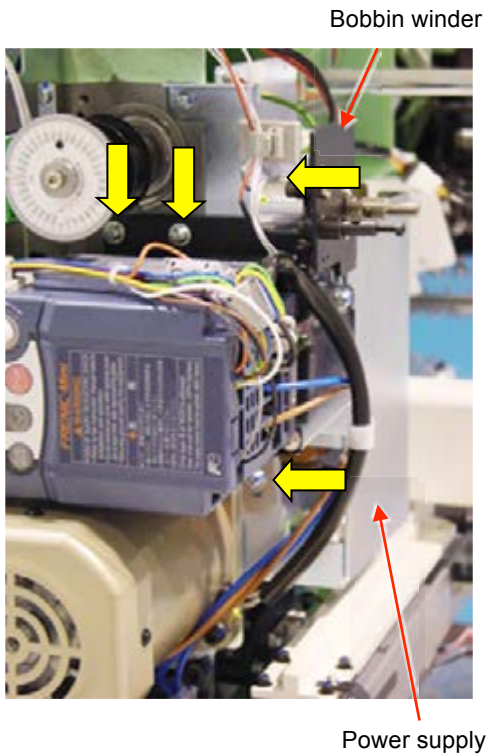

3. Adjust tension of timing belt.

<Important>

Tension shaft ass'y to be set at the center against screw hole of the body.

No need to adjust tension.



Please move tension shaft ass'y upward and downward to adjust.

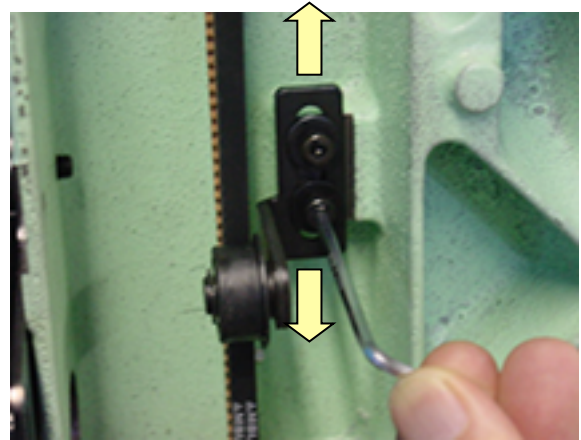

4. Please return power supply to previous places.

5. Please return bobbin winder to previous places then adjustment to finished.

Exchange of timing belt

1. Referring to [3-2-1 Exchange of crank], Remove thread stand, outer covers, thread tension, front panel, moving head and face plate.

2. Remove timing detecting board ass'y.

Cable 1 pcs, Screw 2 pcs

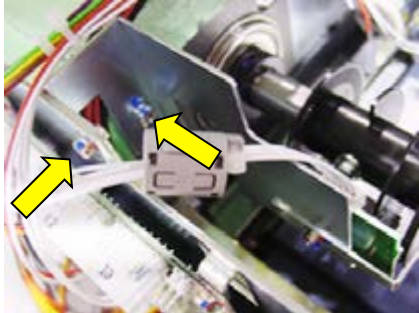

2. Remove winder and power supply.

Screw 4 pcs

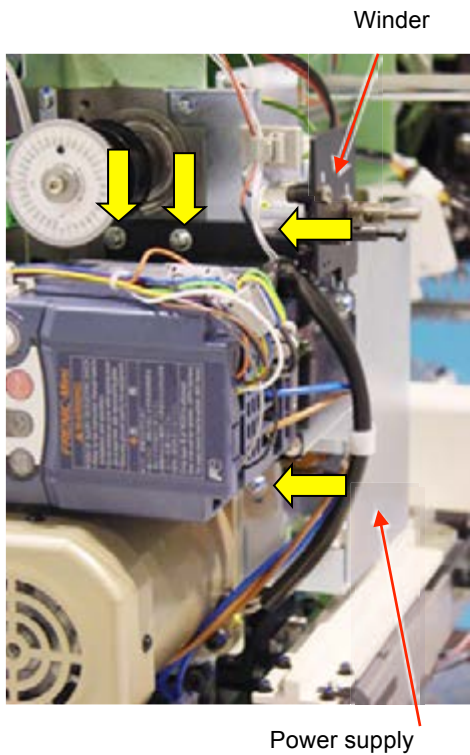

Remove support roller ass'y.



3. Loosen screws on upper shaft collar, upper pulley and drive pulley.

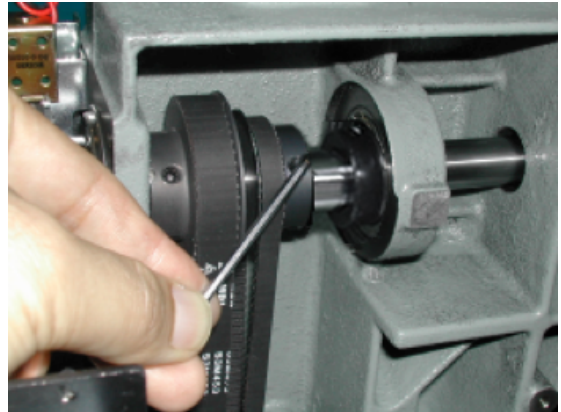

4. Loosen screw on fasten collar for take-up lever cam.

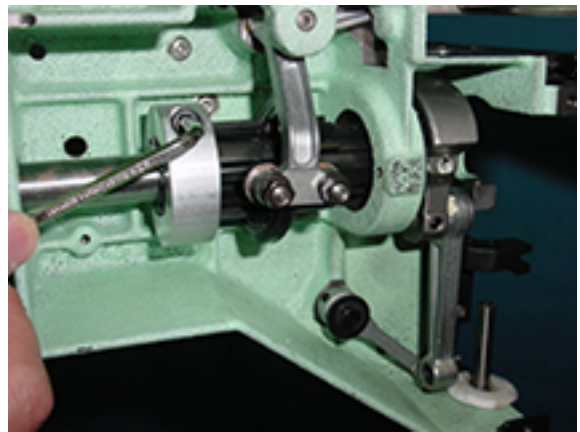

5. Loosen screw on crank.



Exchange of timing belt

6. Pull out upper shaft.

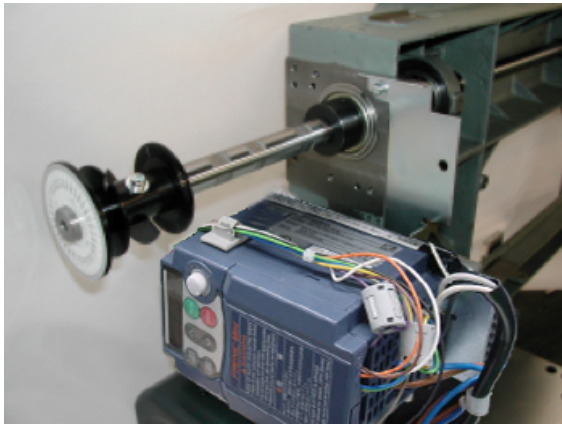

7. Remove upper pulley and timing belt.
Install good timing belt.

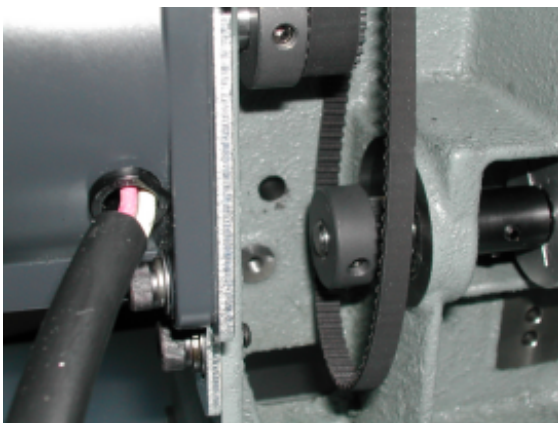
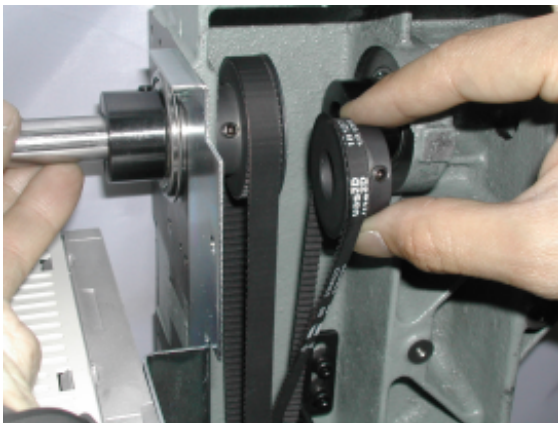

8. Install parts in reverse order.

For installation and adjustment of each unit, please refer to respective manuals.

Referring to [3-8-1 Adjustment of timing belt tension], adjust tensile strength of timing belt.

<Important> Pay attention to following (1) - (4).

(1)When you install upper shaft collar, upper pulley, drive pulley and crank, please fix them on flat surface of upper shaft with screw.

(2)Make sure that pulleys and collars are attached without space from machine body except upper pulley.

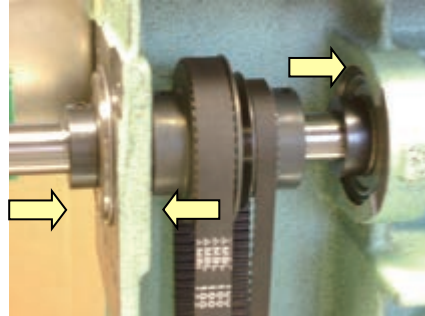

(3)Position of upper pulley is space from upper shaft collar.

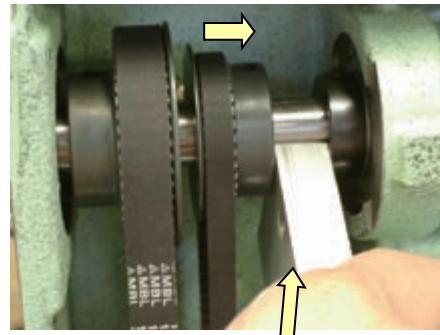

Type of small collar

Thickness gauge [11.5mm]

(4)Confirm that belt is not interfere the pulley flange and not come out from pulley groove.

Adjustment will be done with following pulley.

Timing belt has to be adjusted with [upper pulley position].

Motor belt has to be adjusted with [motor pulley position].

9. Check and adjust following timing to finish.

(1)Lowest needle point

(2)Upper shaft timing(L point, C point)

(3)Take-up lever timing

(4)Rotary hook timing

(5) Needle height

(6) Height of pressure foot

Adjustment of motor belt tension

3-8-3

1. Referring to [3-2-1 Exchange of crank], Remove thread stand and outer covers.

2. Remove winder and power supply.

Screw 4 pcs

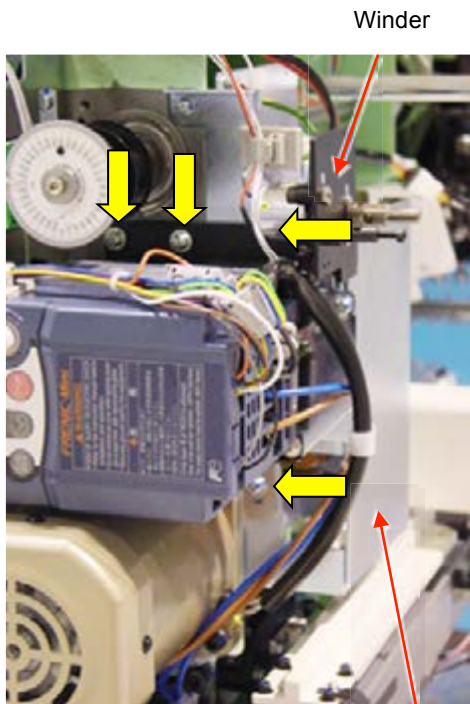

3. Remove two screws shown in the following figure and inverter.

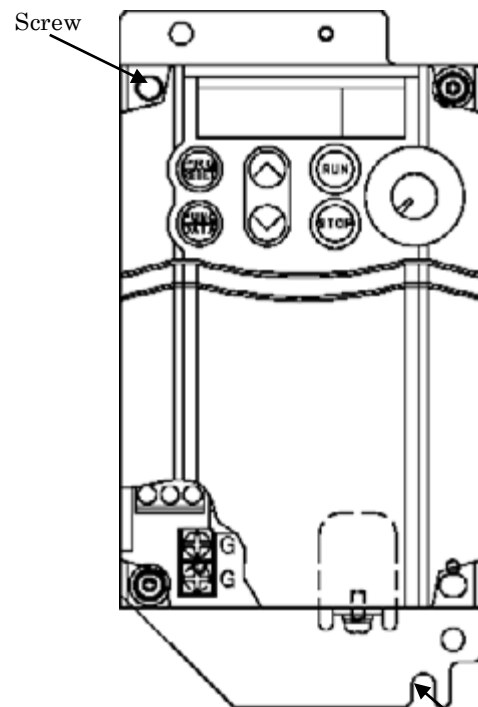
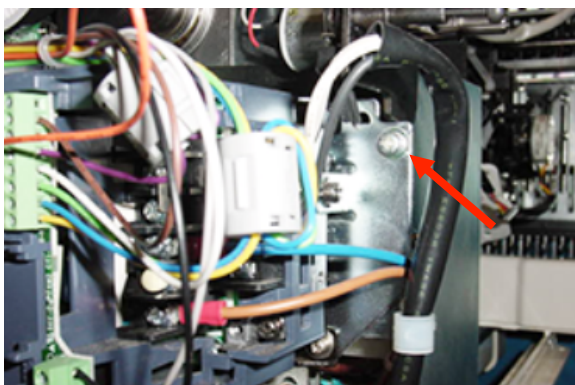

4. Loosen screw on motor bracket.

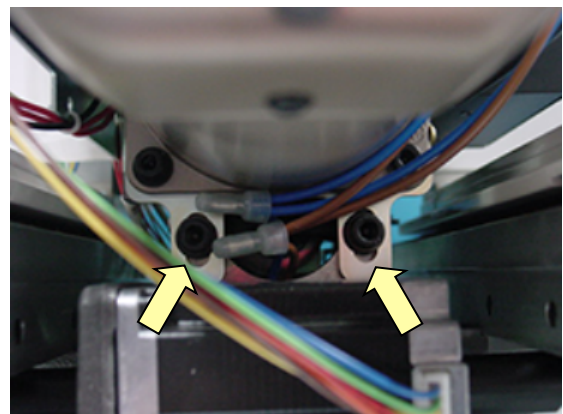

5. Adjust motor belt tension.

Use push and pull gauge.

<Adjustment value> 320 - 330 g / 3mm

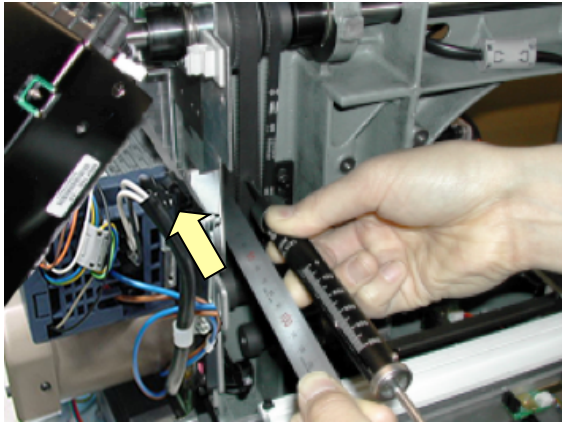

Gauge in the near center between drive pulley and motor pulley.

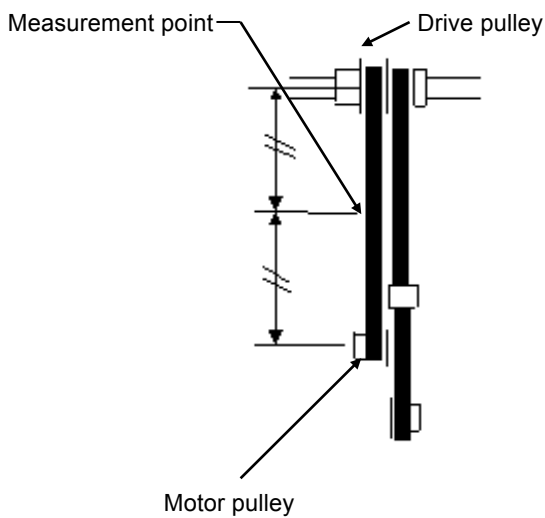

Adjust of tension should be 320 – 330g at belt is pressed 3mm.

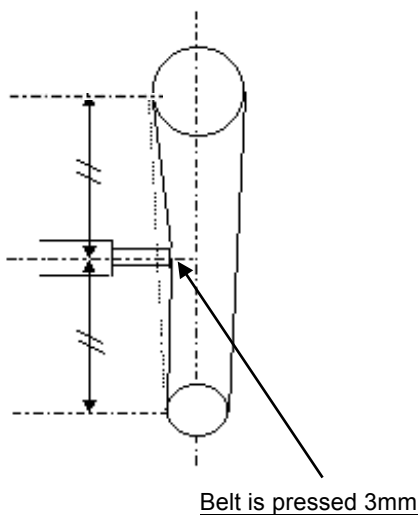

Move main motor upward and downward to adjust.

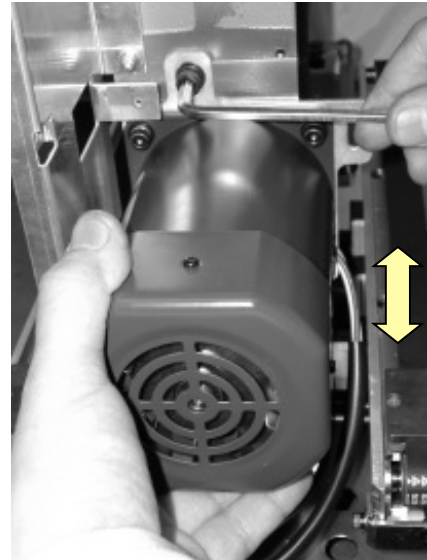

6. Tighten screw on motor bracket.

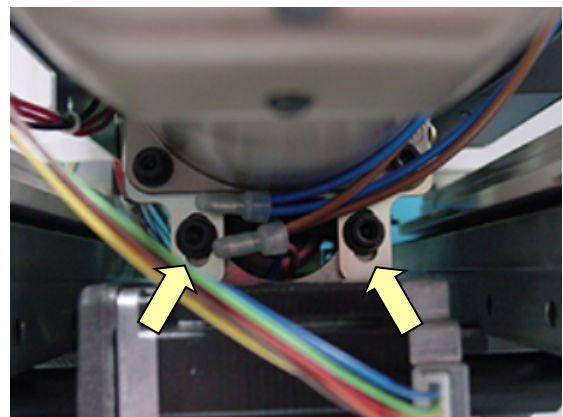

7. Return power supply bracket, power supply, bobbin winder and inverter to previous places to finish.

Exchange of motor and motor belt

1. Referring to [3-2-1 Exchange of crank], Remove thread stand and outer covers.

2. Remove timing detecting board ass'y.

Cable 1 pcs, Screw 2 pcs



3. Remove winder and power supply.

Screw 4 pcs

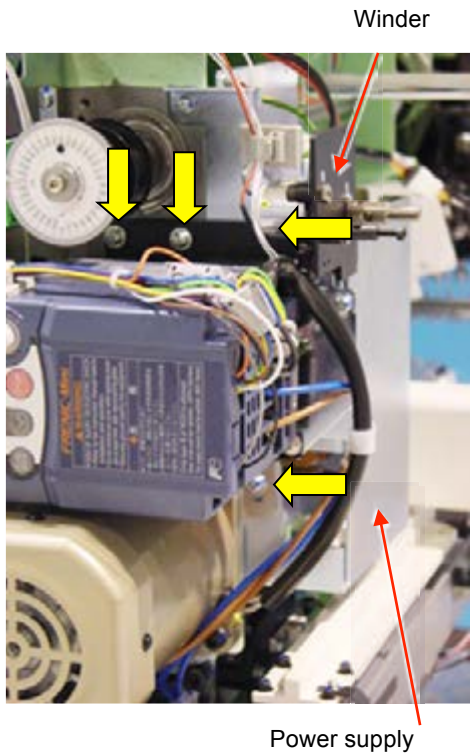

4. Loosen screws on upper shaft collar, upper pulley and drive pulley.

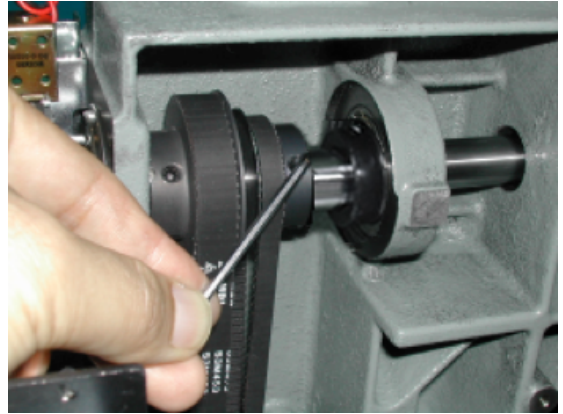

5. Loosen screw on fasten collar for take-up lever cam.



6. Loosen screw on crank.

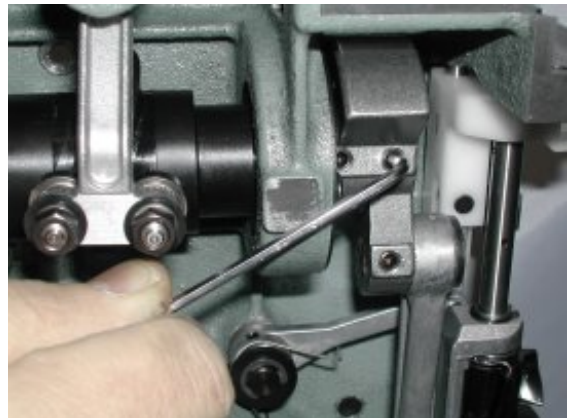

7. Pull out upper shaft.

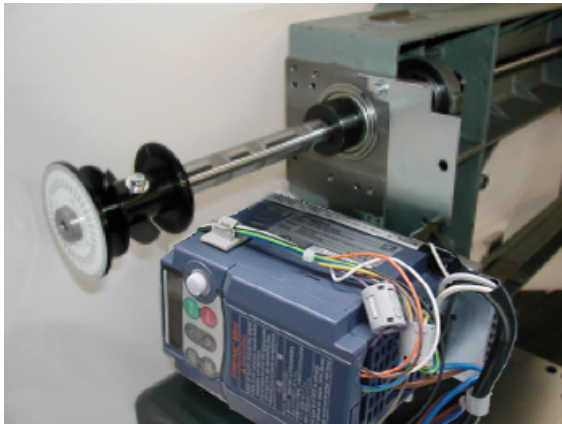

8. Remove drive pulley and motor belt.
Install good motor belt.

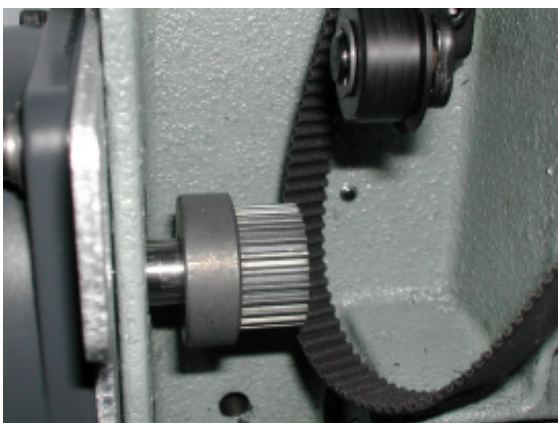
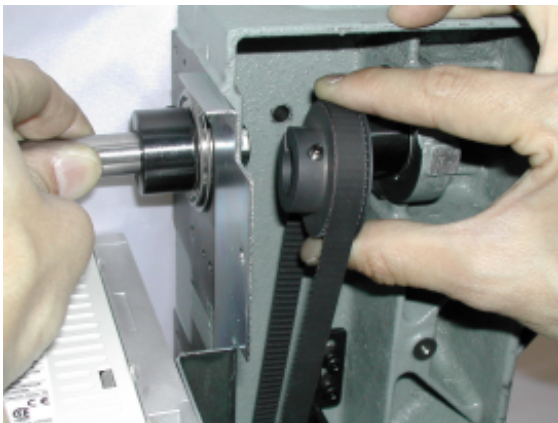

9. Install each parts in reverse order.

For installation and adjustment of each part, please refer to respective manuals.

Referring to [3-8-3 Adjustment of motor belt tension], adjust tensile strength of motor belt.

<Important> Pay attention to following (1) - (4).

(1)When you install upper shaft collar, upper pulley, drive pulley and crank, please fix them on flat surface of upper shaft with screw.

(2)Make sure that pulleys and collars are attached without space from machine body except upper pulley.

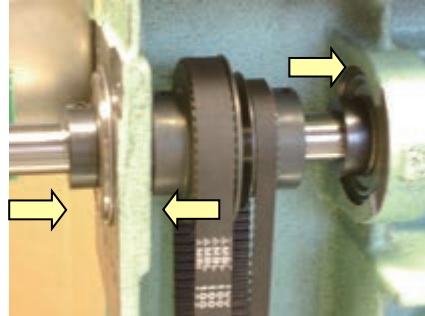

(3)Position of upper pulley is space from upper shaft collar.

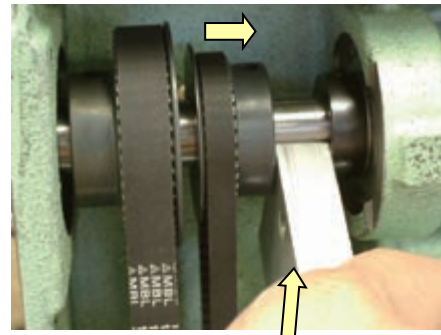

Type of small collar

Thickness gauge [11.5mm]

(4)Confirm that belt is not interfere the pulley flange and not come out from pulley groove.

Adjustment will be done with following pulley.

Timing belt has to be adjusted with [upper pulley position].

Motor belt has to be adjusted with [motor pulley position].

10. Check and adjust following timing to finish.

(1)Upper shaft timing (L point, C point)

(2)Take-up lever timing

(3)Rotary hook timing

(4)Jump device

Remove LCD-T board

1. Remove four setscrews as shown in the figure below and remove rear cover.

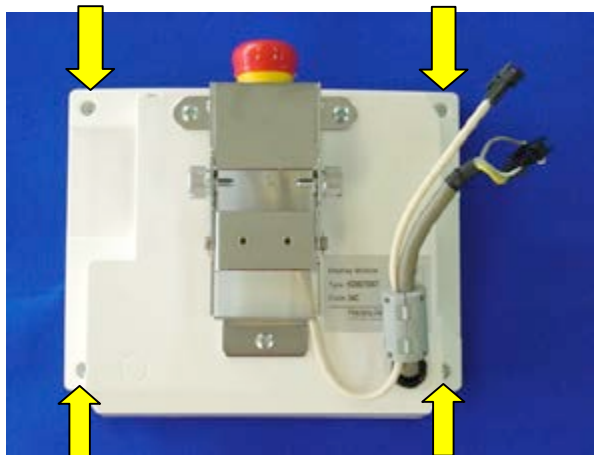

2. Remove connectors for SW cable, Box cable, cable for LCD inverter (red/white).



Box cable
Cable for LCD inverter (red/white)

3. Remove set screw and sealed case A.

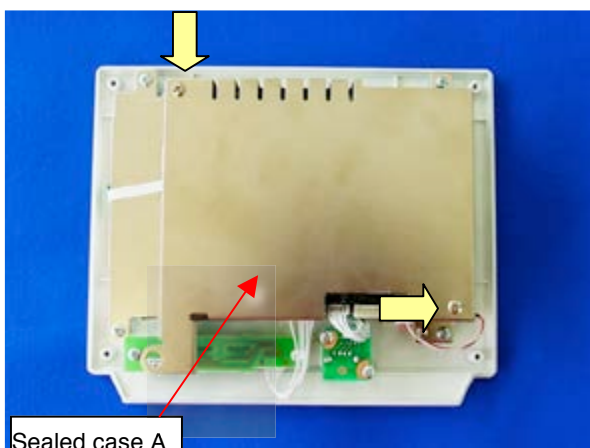

Sealed case A

4. Remove core module.

Spread the latches on the left and right of the arrow outward, and raise the module toward you to remove it.

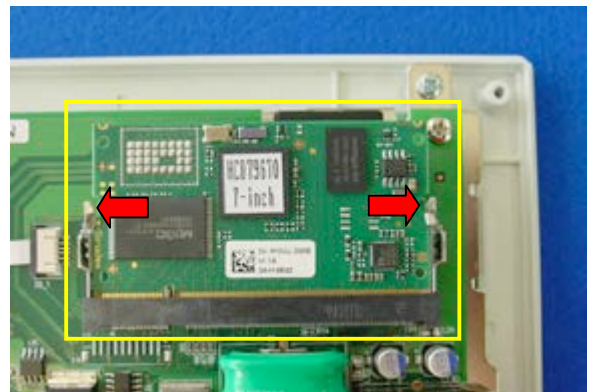

5. Remove narrow flat cable for LCD unit.

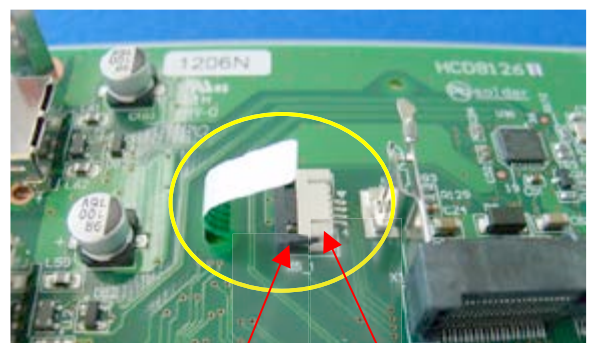

Latch Connector

When you pull the latch to cord side, the cord release.
When you push the latch to connector side, the cord fixed.

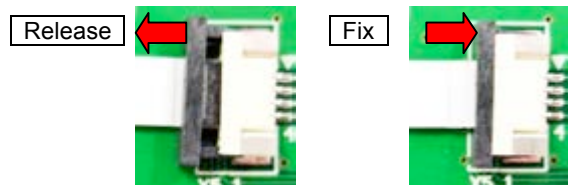

6. Remove two sets screws and two studs.

Release SW cable and USB relay cable.

Setscrew

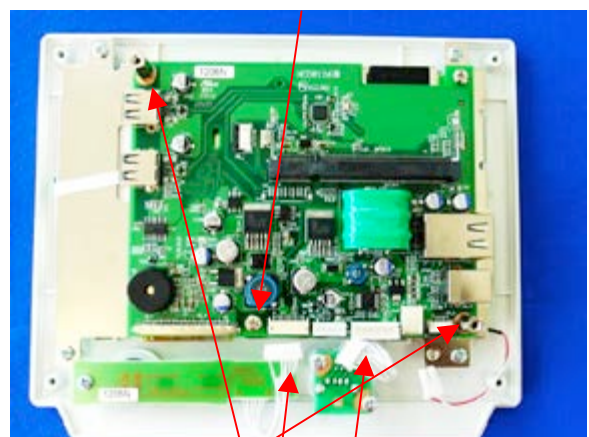

Stud USB relay cable
SW cable

7. Lift LCD-T board as shown in the figure below.

Remove wide flat cable for LCD unit.

(When the tape for fixing is stuck on connector, please peel off.)

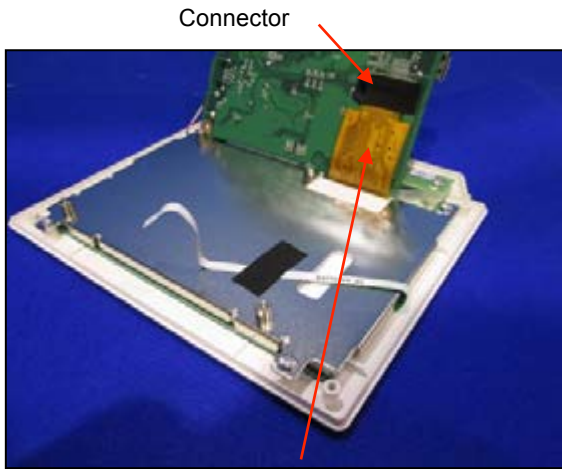

Wide flat cable

When you pull the latch to cord side, the cord release.
When you push the latch to connector side, the cord fixed.

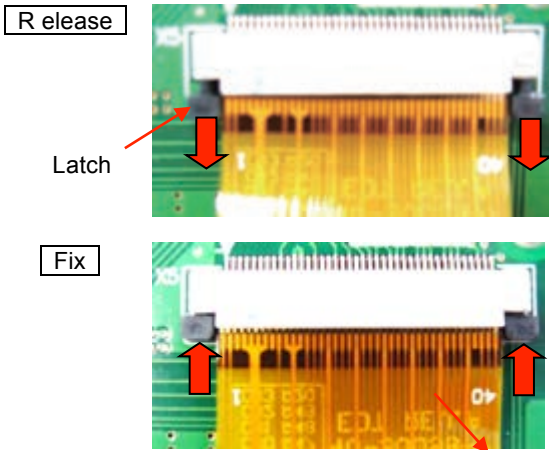

8. Remove four setscrews and LCD unit.

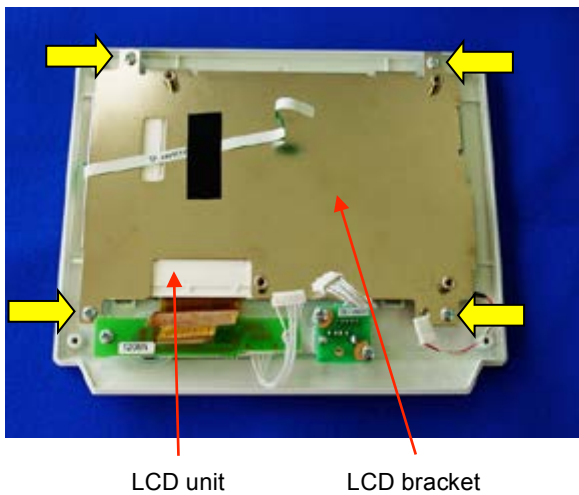

9. Remove touch panel.

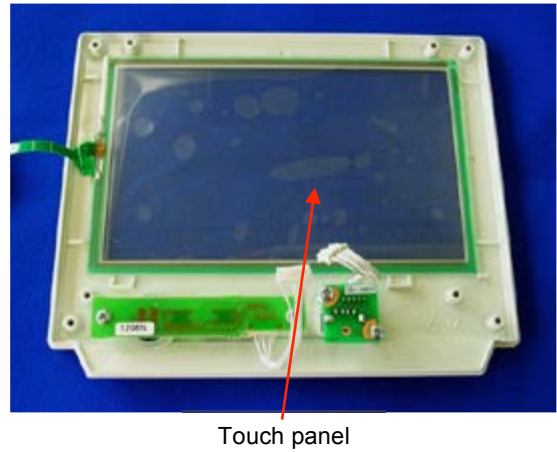

Please reverse procedure when installing LCD-T board.

Memory card

Insert our official memory card (EPZ0122*). Refer to the latest parts list for the parts number.

This memory card contains programs and data for an embroidery machine.

<Notice> Please contact us if you need to use third party's memory card from local market.

The necessary information will be provided.

Make sure to use 4~16GB SD card capacity and please ask us for needed data file.

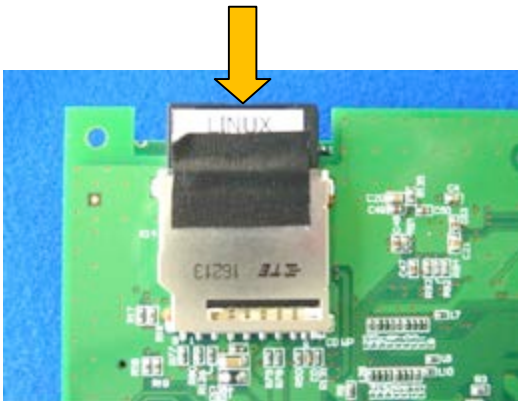

Back-up battery

The battery is used for back-up power source of real-time clock on an embroidery machine.

Replace new LCD-T board if clock dose not indicate the correct time after setting a clock and turning power switch OFF.

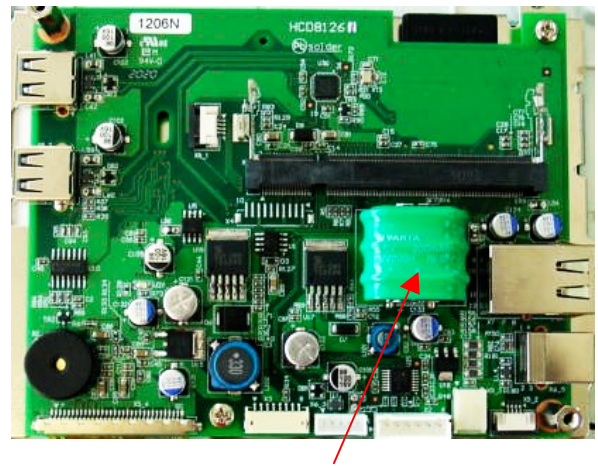

Back-up battery

Disposal of back-up battery of LCD-T board



When disposing of the LCD-T board, remove the back-up battery.

Dispose of the back-up battery by following the method specified by each country or each region.

(Disconnect power plug from electrical outlet before work.)

(Please use digital output tester)

1. Turn the machine on and put tester against terminal plate or connector, then turn V-ADJ to adjust to $[24.6V \pm 0.1V]$.

for 100V

For 200V

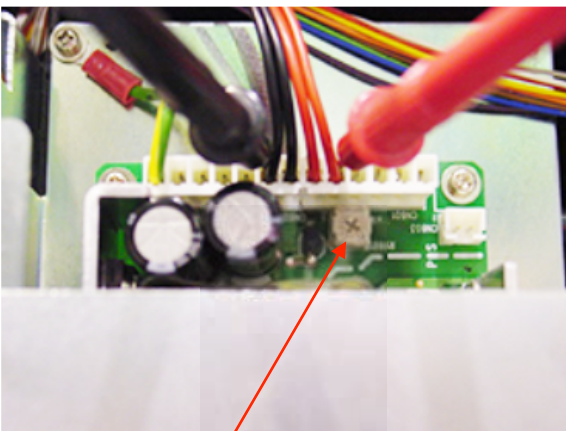
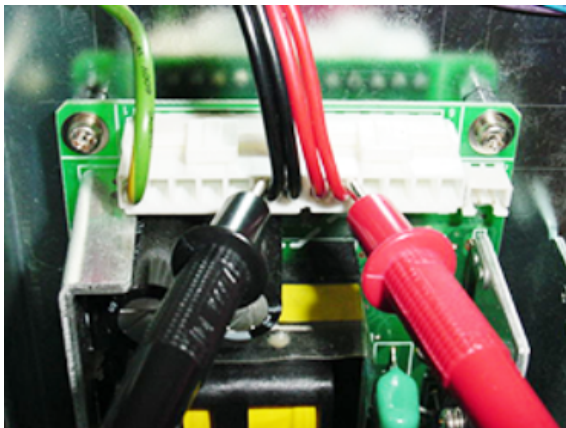

VR

1. Remove bobbin thread winding motor ass'y.

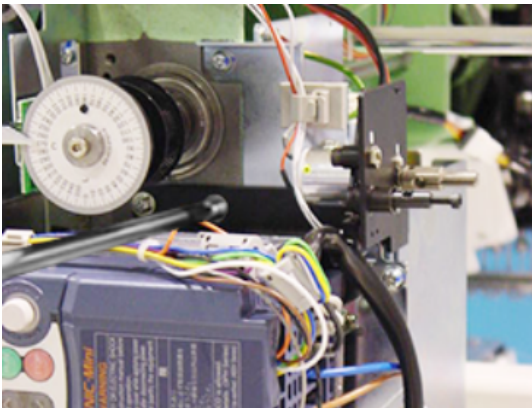

2. Fix 2 screws tentatively timing detecting board.

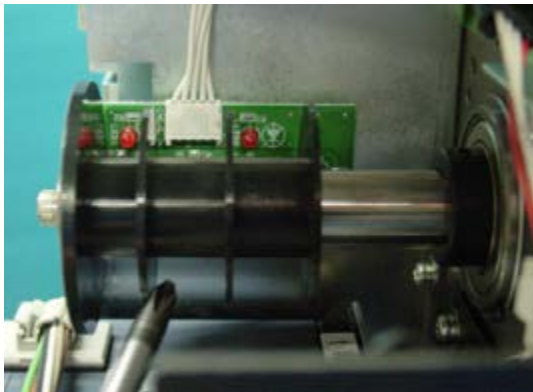

3. Set upper shaft to [0 degree].

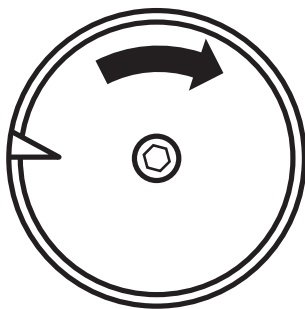

4. Move circuit board up and down and set to position where LED 2 disappears at [0 degree], then fix with screw.

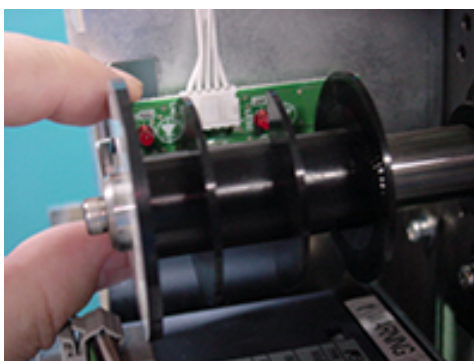

5. With this state, turn to C point and check if LED1 lights between [265 and 282 degrees].

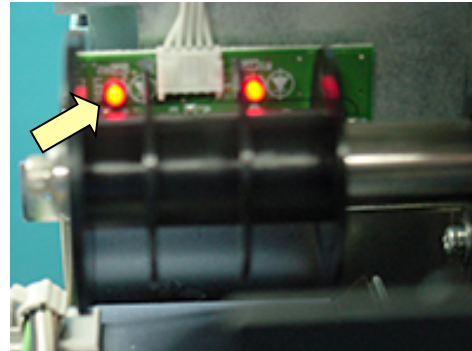

* Check dose not scratch plastic slit to Timing sensor.

6. Put bobbin thread winding motor ass'y back to where it was.

Viewing from side of circuit board, set slit so that it comes to center of sensor, fix it.

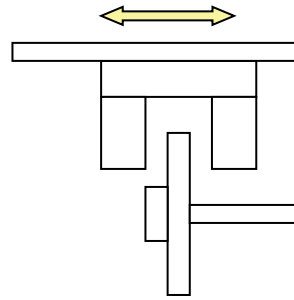
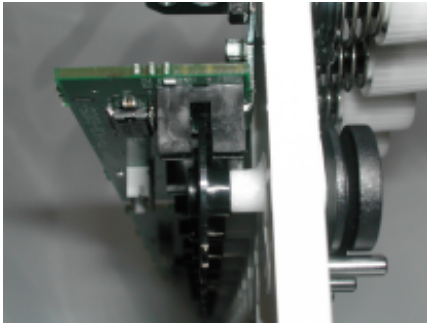

4-2-3 Adjustment of stop position of needle bar change unit

1. Remove potentiometer ass'y.

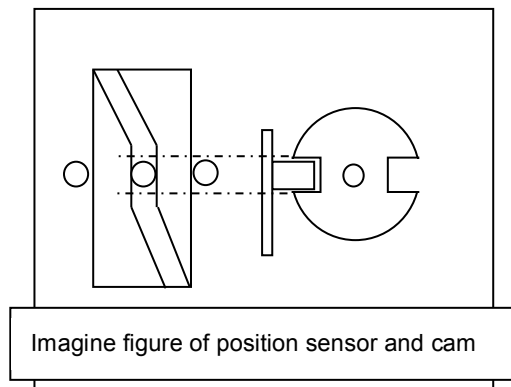
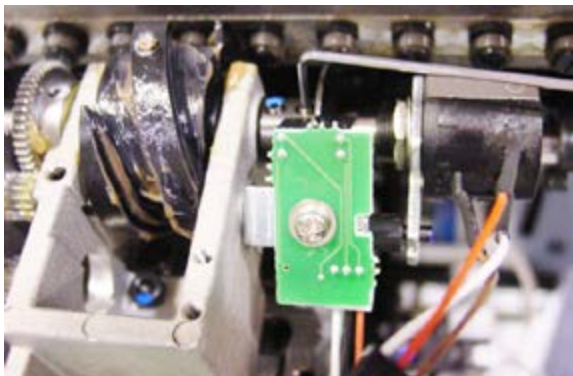

2. Set position where sensor on sensor board and slit don't cross to area where moving head doesn't move when turning groove cam.

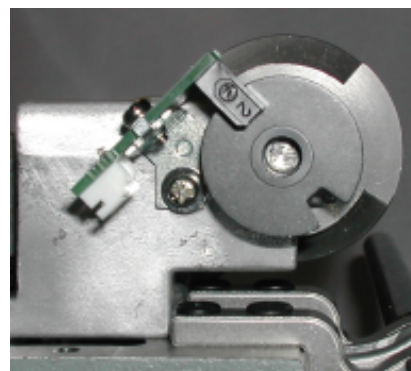
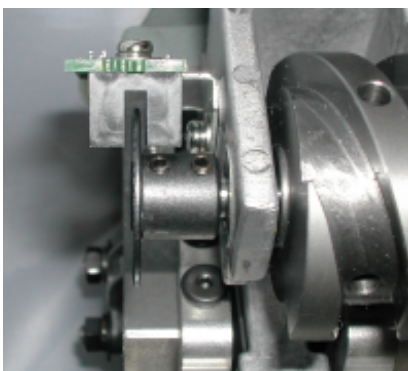

3. After installation, please fix potentiometer referring to [3-4-2 Setting to detect needle position].

Remove of Inverter

<Notice>

Please disconnect machine inlet from the wall.

<Check>

Before you start to work, make sure the display of inverter is off.

1. Remove outer cover. Refer to [2-2 How to remove outer cover].

2. Remove control terminal cover.

Insert fingers in a gap (under the "PULL" indication) on the underside of control terminal cover, and pull the cover toward yourself and remove it.

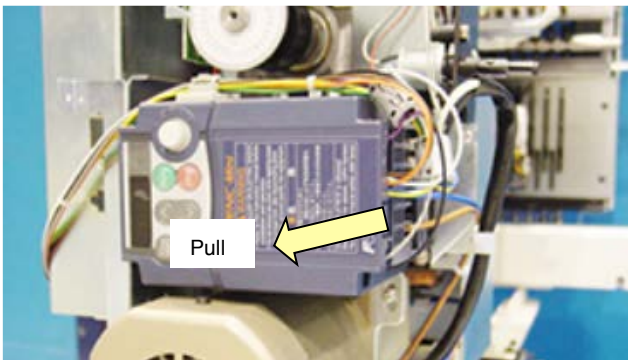

If screw is provided on the cover, remove it.

3. Remove main terminal cover

Hold both left and right ends of main terminal cover with fingers and slide the cover toward yourself and remove it.

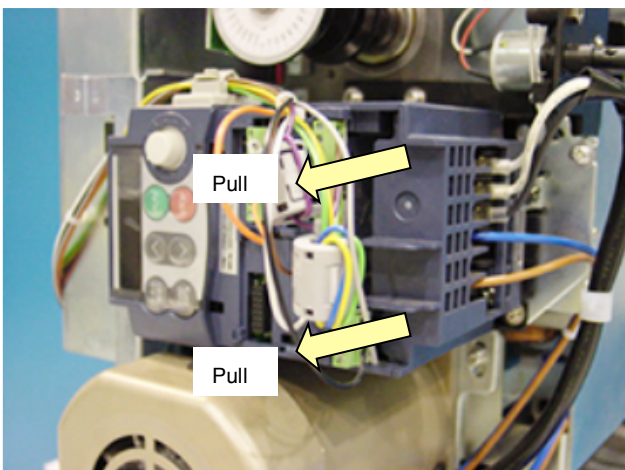

4. Loosen screw with Phillips screwdriver for precision instrument and remove 9 cables. (Cable color: ORANGE, BROWN, PURPLE, WHITE, GREEN, BLUE, YELLOW, BLACK, and GLAY)

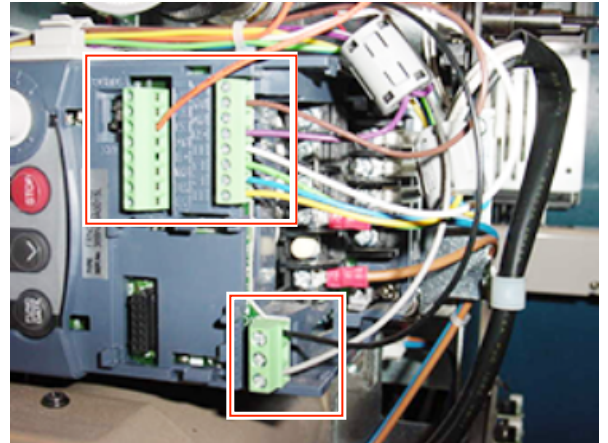

5. Remove screws with Phillips screwdriver and remove power cable and motor cable. (Cable color: GLAY, WHITE BLACK, BLUE, and BROWN)

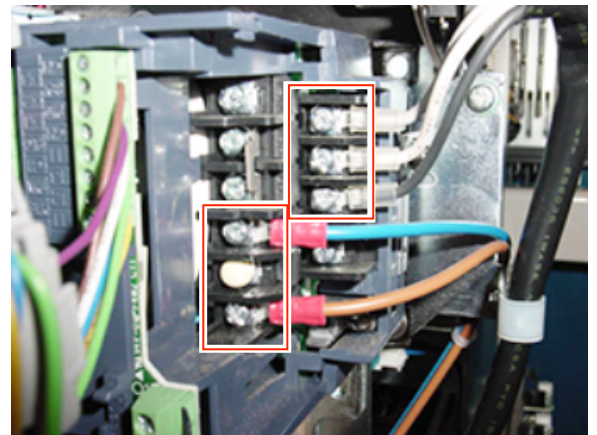

6. Remove cable from clamp.

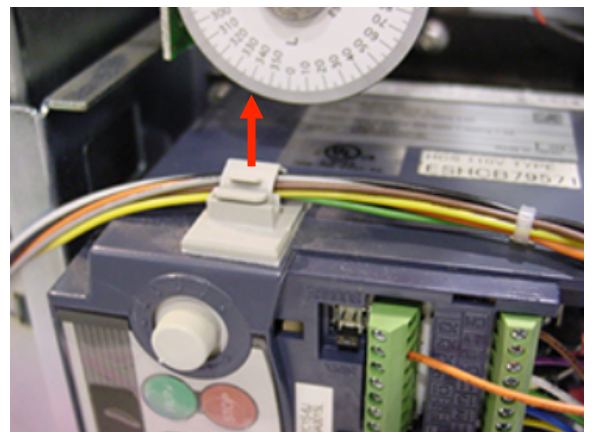

7. Remove two screws shown in the following figure and inverter.

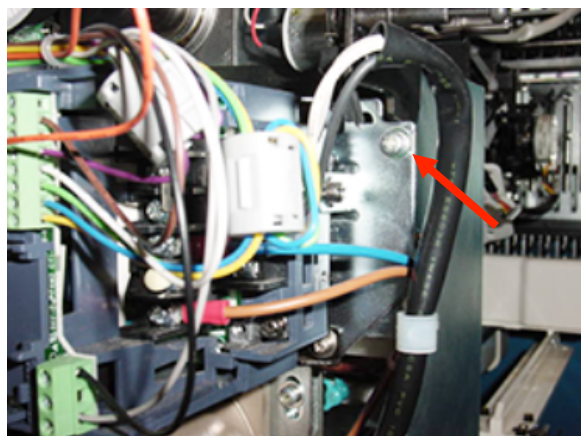

End of process.

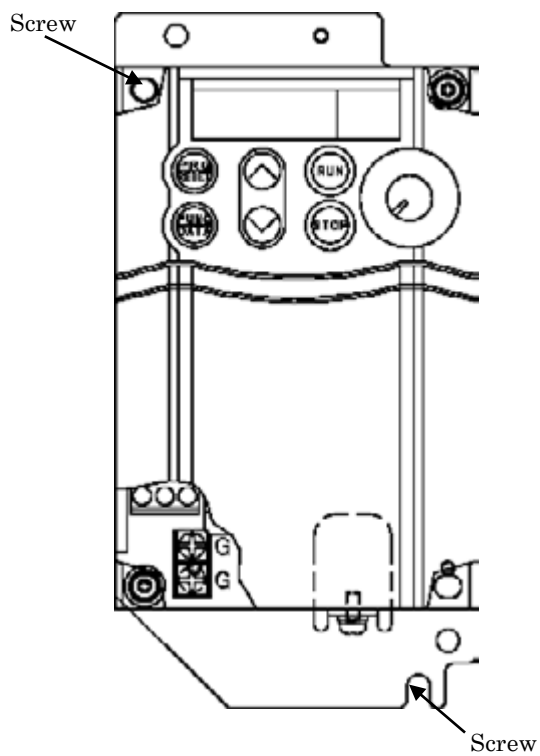

Inverter for 110 - 120V

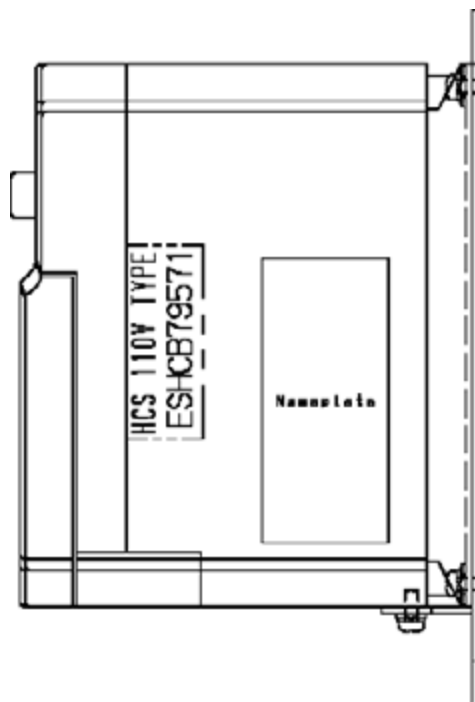

Inverter for 200 - 230V

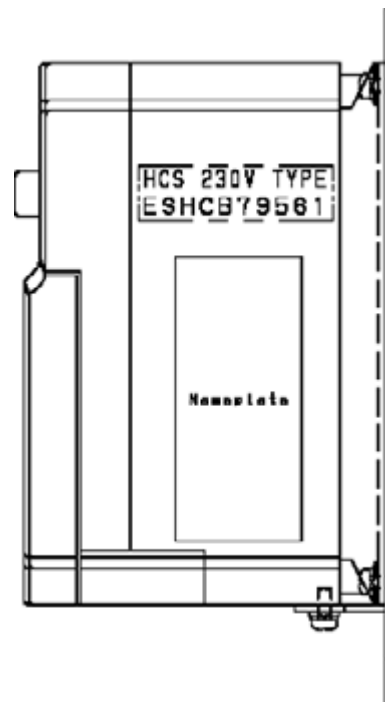

Inverter Installation

<Note>

Please check your replacement inverter type and machine voltage specification before replace inverter.

Sticker on inverter

For 110 - 120V

HCS 110V TYPE
E S H C B 7 9 5 7*

For 200 - 230V

HCS 230V TYPE
E S H C B 7 9 5 6*

Refer to specification sticker for voltage specifications of the machine.

1. Remove control terminal cover.

Insert a finger in a gap (under the "PULL" indication) on the underside of control terminal cover, and pull the cover toward yourself and remove it.

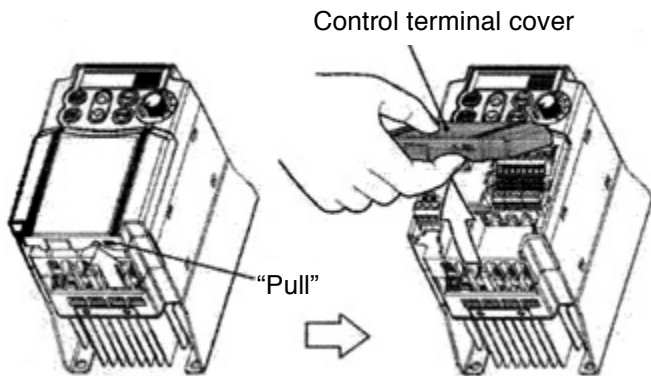

2. Remove main terminal cover

Hold both left and right ends of main terminal cover with fingers and slide the cover toward yourself and remove it.

Main terminal cover

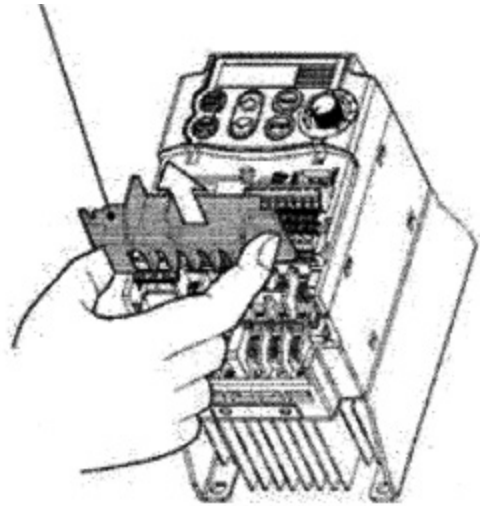

3. Install inverter in the machine with two screws tightened.

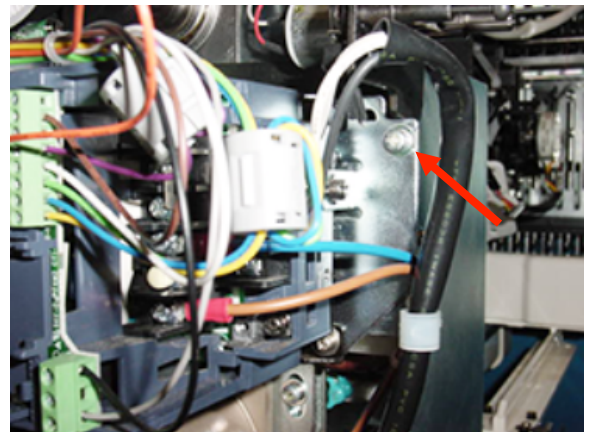

4. Tighten screws with screwdriver to install power cable and motor cable per the following connection diagram.
 (Cable color: GLAY, WHITE, BLACK, BLUE, BROWN)

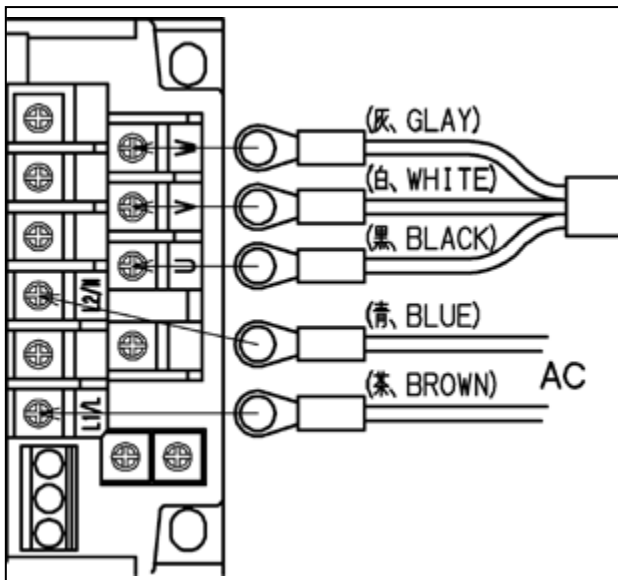
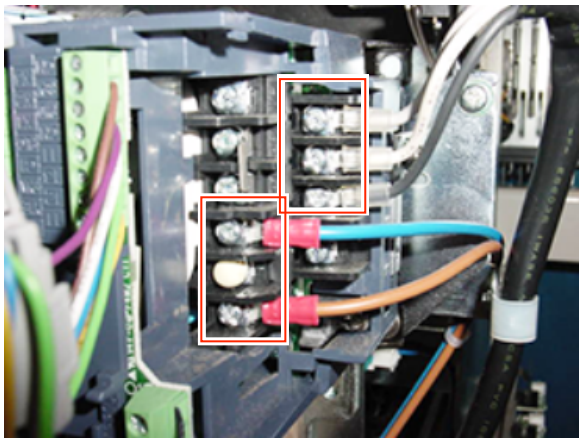

5. Tighten screw and connect 9 cables the following connection diagram. (Cable color: ORANGE, BROWN, PURPLE, WHITE, GREEN, BLUE, YELLOW, BLACK, and GLAY)

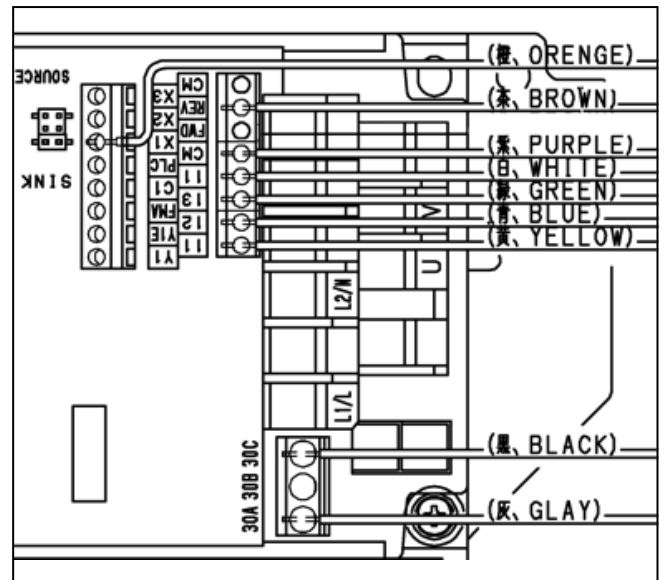
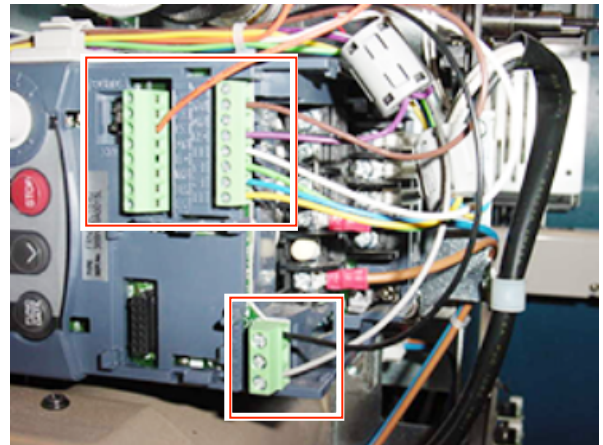

6. Fix cable to the clamp.

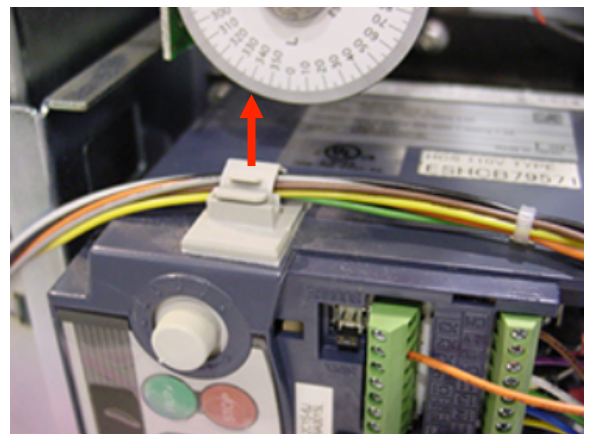

7. Set main terminal cover

Install main terminal cover

Hold both left and right ends of main terminal cover with fingers and install the cover in the inverter

<Note>

Install main terminal cover not to apply stress to the cable. If stress is applied to the cable, load is applied to the screws for the main terminal and the screws might be loosened.

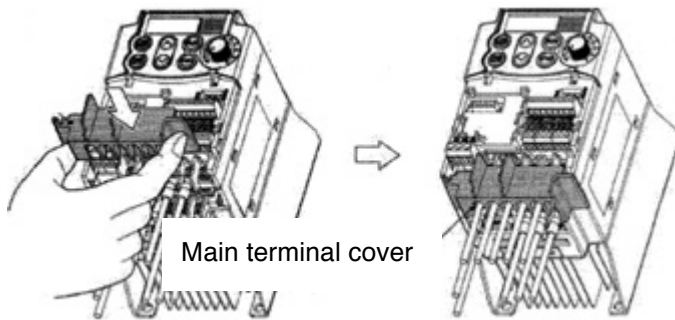

8. Install control terminal cover

Install the cover by inserting the nail on top of the cover to the ditch of the inverter.

Do not pinch any cables with the cover.

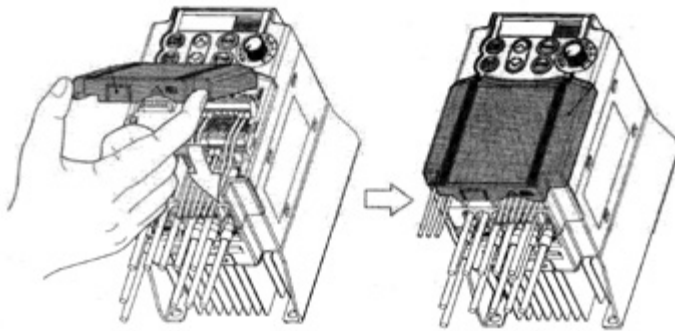

9. Referring to [4-4-4 Setting of revolution],

Perform [Initializing of machine speed].

Inverter Installation is done.

<Note>

Check if voltage specifications of the machine and inverter are matched before installation.

In case of spare parts supply, parameter is preset. Please contact HAPPY, when you need to change it.
 Parameter cannot be set while machine is running .
 Pay attention to electric wires as setting is done with power is on.

How to release the setting change prohibition

Release the prohibition by following the procedures below since parameter is set as setting change prohibition.

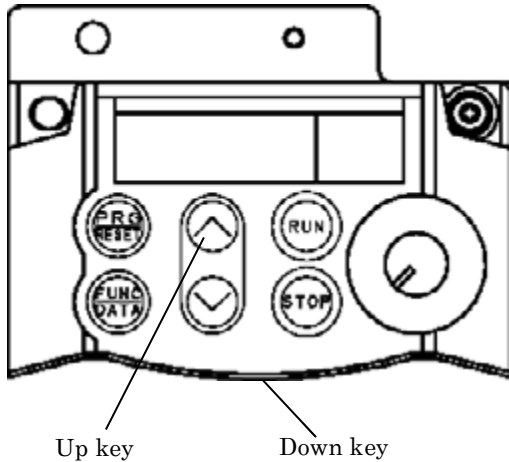

1. Press **PRG/RESET**.
 [I.F _ _] is displayed.
2. Press **FUNC/DATA**.
 [F 0 0] is displayed.
3. Press **FUNC/DATA** again.
 [1] is blinking.
 (This means setting change is prohibited.)
4. Press Up key or Down key while pressing **STOP**.
 [0] is blinking.
 (This means you can change settings.)
5. Press **FUNC/DATA**.
 After [SAVE] is indicated,
 [F 0 1] is displayed.
 By above process, you will be able to set parameters.

Next, change each setting.

6. Press Up key and function code is displayed. Select the function code whose parameter you would like to change.
 (Press Up key and the function code returns to the previous code.)

The following table shows function codes, setting details, and factory default setting. Functions other than described below are initial setting of inverter.

Refer to the next clause for the method of initial setting.

Code	Function	→	Setting
F 0 0	Prohibition of change	→	1 (Protect)
F 0 1	Frequency set mode	→	1
F 0 2	Drive / Operation	→	1
F 0 3	Maxmum frequency	→	85 . 0
F 0 5	Base frequency volteage	→	200
F 0 7	Acceleration time 1	→	2 . 0
F 0 8	Deceleration time1	→	0 . 5
F 1 1	Motor thermal protection	→	0 , 63
F 1 5	Upper limit freq. limiter	→	85 . 0
F 2 0	DC brake. starting freq.	→	1 . 0
F 2 1	DC braking current	→	30
F 2 2	DC braking time	→	0 . 5
F 2 3	Start frequency	→	0 . 5
F 2 6	Carrier frequency	→	6
F 2 7	Tone	→	2
F 3 7	Load selection	→	2
C 0 5	Multi stage frequency 1	→	2 . 3
C 3 3	Analog input filter	→	0 , 05
C 3 4	Analog input adjustment	→	50 . 0
C 5 0	Bias frequency	→	0 . 0
P 0 2	Motor capacity	→	0 . 09
P 0 3	Motor rated current	→	0 , 63

7. Select the code you would like to change and press **FUNC/DATA**.
 Parameter of the function is displayed.
8. Change parameter by pressing Up or Down key.
9. Press **FUNC/DATA**.
 After [SAVE] is displayed, the next function code is displayed.
 This means change of the function code is made.

How to set the prohibition setting

10. After each setting is done, select [F 0 0] by pressing Up or Down key to return to setting change prohibition.

11. Press **FUNC/DATA**.
[0] is blinking.

12. Press Up key while pressing **STOP**.
[1] is blinking.

13. Press **FUNC/DATA**.
After [S A V E] is displayed,
[F 0 1] is displayed.

14. Press **PRG/RESET**.
[I.F _ _] is displayed.

15. **PRG/RESET** again.
Return to normal mode.

Please note that you are unable to make this setting while the machine is running.

When setting is mistakenly made in mid way, the setting will return to parameter in normal standard in one action.

Thereafter please change to parameter you want to set.

1. Enable parameter to be changed by referring 1. to 5. in

[How to set inverter].

2. Press **PRG/RESET**.

[I.F _ _] is displayed.

3. Select [I.H _ _] by pressing Down key 3 times.

4. Press **FUNC/DATA**.

[H 0 3] is displayed.

5. Press **FUNC/DATA** again.

[0] is displayed.

6 Press Up key while pressing **STOP**.

[1] is displayed.

7. Press **FUNC/DATA**.

After [S A V E] is displayed,

[0.06] - [0.07] is displayed.

8. Press **FUNC/DATA**.

[I.F _ _] is displayed.

The settings of inverter become initial settings.

Then, change parameter and return to prohibition setting by referring to the previous clause.

* The sequence of procedures of program update is described below..

If you need more details, please refer to Instruction book for embroidery machine.

-
- | | |
|---|---|
| 1. Insert the updated program downloaded USB memory to the USB port of the machine. | } Maintenance Manual
4-4-3 Each program update
Instruction book
18-3 Version information and software update |
| 2. Press [MENU] button and select [Version] in menu of [OTHER] for update each program. | |
-
- | | |
|---|---|
| 3. Press [MENU] button and select [System] in menu of [OTHER] for initialization of system. | } Instruction book
25-1 Initialize machine |
|---|---|
-
- | | |
|---|--|
| 4. [Replacement of LCD-T board]
Calendar setting | } Instruction book
3-7 Calendar setting |
|---|--|
-
5. end of process

* If there is a problem with the machine after updating the program, press [MENU] button and select [Speed] in menu of [OTHER] for automatic speed setting. (Instruction book 25-2 Initialize speed)

* Download updated program file.



Program

for HCS3 " UPDATE_*.**.IMG "

<NOTE 1>

- Copy the program to the root folder of USB memory.

1. Insert USB memory that contains data for version up into insertion slot on the control box.

2. Press  (MENU) and press  (OTHER).



3. Press Version.

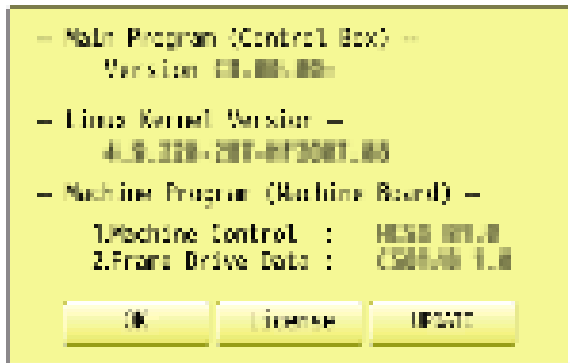

4. Press UPDATE.

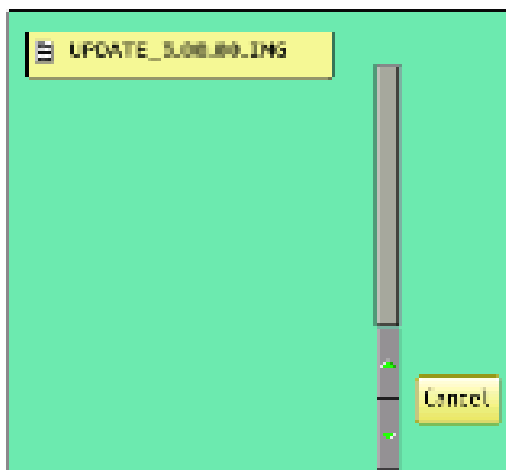

5. Select the file "UPDATE***.IMG".

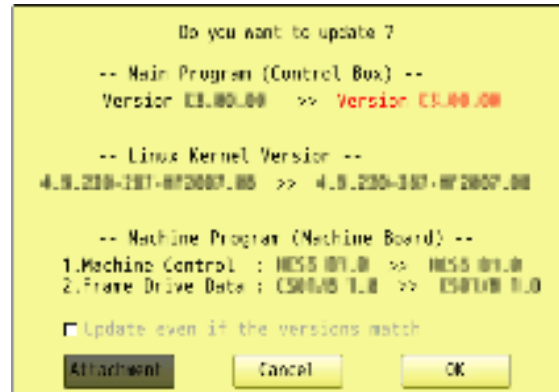

When the version of each program and the version in the update file are different, the version number is displayed in red.

Update even if the version match

(OFF) : Only different versions of the program will be updated.

(On) : All programs will be rewritten even if the version number is the same.(Up to 16 minutes)

<NOTE>

- * Please do not take out USB memory during installation.
- * Please do not turn off the power during installation (it will take for a while for completion of installation).

Retry updating when the screen shows "Error" due to writing error.

4. Press OK.

Installation of program begins.

Once update is complete, the machine will be rebooted automatically.



5. Press NEXT button.

6. Referring to [4-4-4 Setting of revolution], Perform [Re-Initialization of machine system] And [Initializing of machine speed].

* End of process.

Initialization the system

Perform this function only to fix problems with the machine.

When performed, all settings in the "OPTION" menu are lost.

Be sure to reset the "OPTION" menu after performing this function.



Initialize the PMS

Please activate this function when the embroidery machine has malfunction after the operation with Happy PMS (Production management system). Please refer to instruction book of "Happy PMS" for more precise information.

Initialize the Network

When performed, all settings in the "Network" menu are lost.

1. Turn on the power. After the program start up,

press  (MENU) and press  (OTHER).

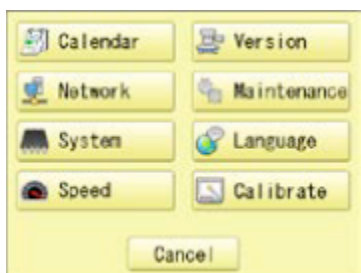

2. Press **System**.



3. Press **Initialize the system**.

Go on to step 5.

Press **Initialize the PMS**.

Press **Initialize the Network**.

4. Press **OK**.

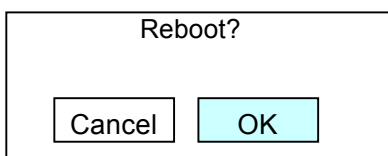

5. Press **OK**.

Formatting of the machines systems are carried out. Indicate HAPPY logo in screen.

End of process.

Initializing of machine speed

Setting of revolution of main shaft, which is suitable to the machine is required.

If setting is not done, the revolution may not speed up.

1. Turn on the power. After the program start up, press

 (MENU) and press  (OTHER).

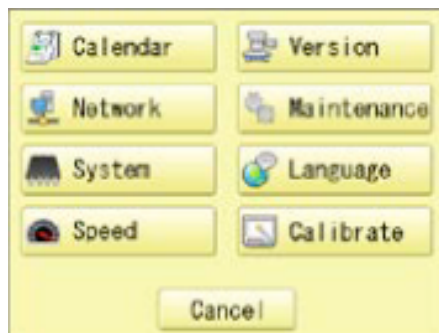

2. Press **Speed**.

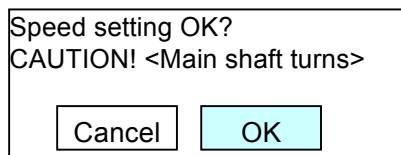

3. Press **OK**.

Main shaft adjusts its revolution speed automatically.

Message complete will be displayed when setting is finished and it goes back to drive mode.

Maintenance mode consists of 9 items as shown below.

- Machine Test—————Movement test, maintenance, and adjustment
- Machine Setting—————Machine control setting
- Memory All Clear—————Initialization of design memory.
- Main Program Update—————Update of operation program and language data
- Machine Program Update—————Update of control program and frame move data
- Frame Position Entry—Registration of coordinates for positioning sensor
- Record—————Total number of stitches, Error occurrence record, Occurrence record by error type.
- Maintenance Register—————Registration of machine maintenance date(Normally not used at maintenance)
- Other—————Other (This item is neither configured nor used.)
- License Registration—————Limited usable period
- Replaced CONT Board—————Machine Setting Navigation after exchanging CONT board (Main program Ver.*1.34~)

How to enter maintenance mode

1. Turn on machine.



1. Press **NEXT** while pressing **START/STOP** button at the screen of the control box after booting the machine.

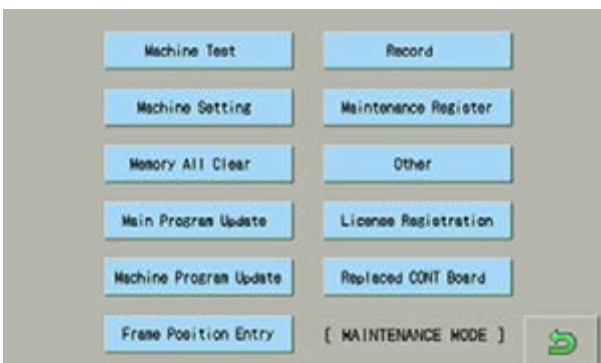

3. Change to Drive screen when you press .



You can enter maintenance mode again by long key press of  (Menu) at the Drive screen after maintenance mode is finished.

However, you cannot use the reentry method above once the machine is turned off and rebooted.

Below operation will be moved solely. In some operations, actuator of motor will be moved, Keep hands and face away during movement for your own safety.

- #1 Needle Adjust : Input of Needle bar detect Potentiometer (Not used in HCH Plus)
- #2 Cutter Adjust : Action test of moving knife Open-Close
Use this function to adjust stop position of Moving knife.
- #3 Catcher Adjust : Action test of Thread catch hook
This test is used to adjust stop position of Thread catch hook.
- #4 Keeper Test : Action test of Keeper solenoid ON-OFF
This test is used to check action of Keeper.
- #5 Jump Solenoid Test : Movement test of jump device ON-OFF
This test is used to check movement of Jump device.
- #6 Catcher Test : Movement test of thread catch hook IN-OUT
Use this test to check movement of Thread catch hook.
- #7 Cutter Test : Action test of moving knife Open-Close
Use this function to check opening-closing action of Moving knife.
- #8 Clip Solenoid : Action test of clip type thread holder (Not used in HCH Plus)
This test is used to check movement of clip type thread holder.
- #9 Pointer Test : Action test of laser pointer
This test is used to check action of Laser pointer.
- #10 Fan Drive Test : Action test of cooling fan ON-OFF (Not used in HCH Plus)
Use this function to check movement of cooling fan.
- #11 Encoder Check : Input test of L point / C point timing
With turning main shaft, you can use this function to check if L point signal, C point signal, and timing signal are correct or not.
- #12 Position Data Entry : Position Data Entry Confirm frame moving sensor
This test is used to check action of Frame moving sensor.

The Pulse motor will be un-locked when you activate the test, then you can move the embroidery frame to your desire position.

- #13 Position Data Entry : Confirm registration of frame position data (Not used in HCH Plus)
You can use this function to check if Frame position data are entered correctly.
- #14 Shaft Drive Test : Main shaft control test
You can turn main shaft with pushing “Start” or “Jump” key of Needle bar section.
This function can be used for test run after maintenance work.

#15 Sequin test (Not used in HCH Plus)
This test is used to check or adjust of Sequin device.

#16 Rotary Hook Adjust
This function can be used for [Adjustment of needle height] or [Adjustment of rotary hook timing].

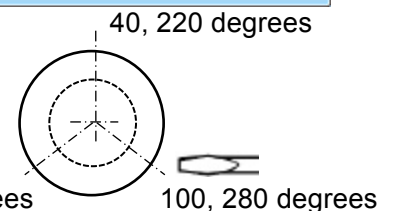
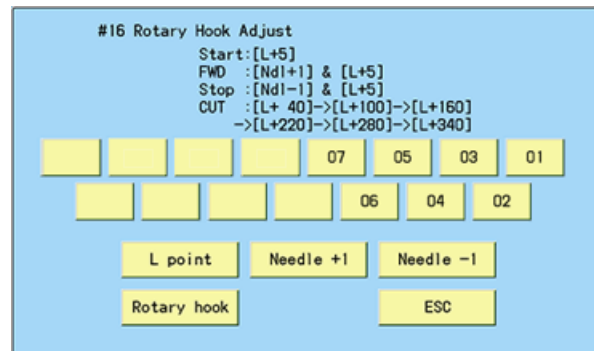

- [01]–[15]: Needle change
- [L point]: Main shaft will turn and set Needle bar position for [Adjustment of needle height] (L+5 degree).
- [Rotary hook]: Rotary hook will turn and stop every 120 degrees to access 3 fixing screws easier.
- [Ndl +1],[Ndl -1]: Needle bar moves to the left or right, then sets Needle bar position for [Adjustment of needle height] (L+5 degree).



#17 Needle Posi. Adjust (Not used in HCH Plus)

1. Enter maintenance mode in reference to [9-1 How to enter maintenance mode]

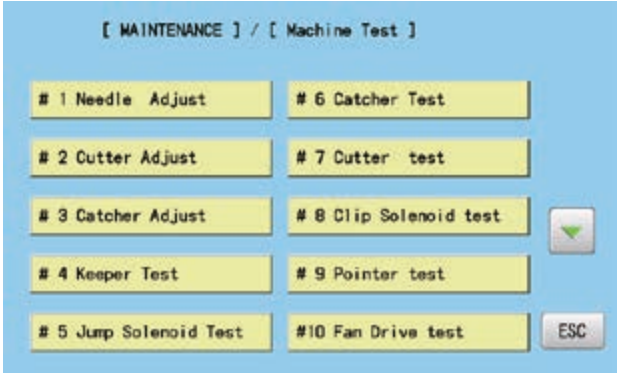
2. Press **Machine Test** .



3. Select desired number to be confirmed.

Page is switched by pressing   .

Selected item will be executed.

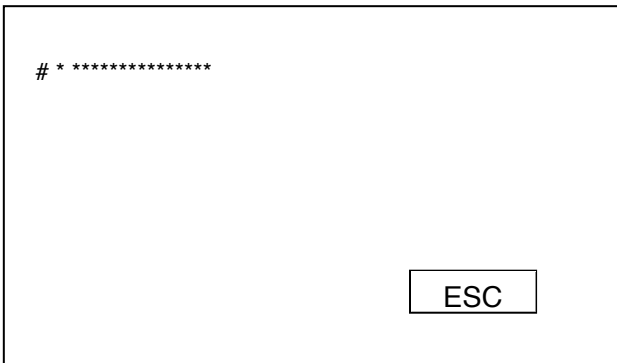

4. The screen returns to the [MACHINE TEST] screen by pressing **ESC** .

(Unnecessary to press **ESC** if the item completes automatically.)

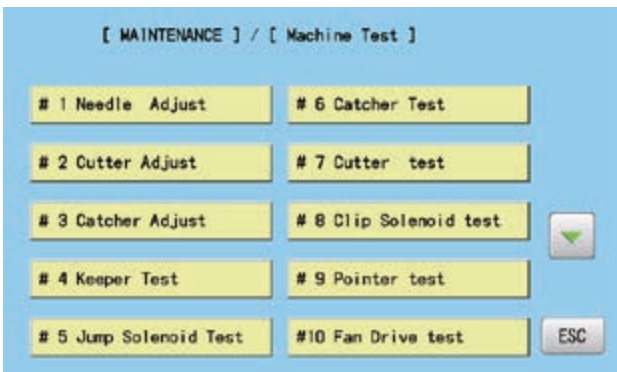

5. Return to drive mode by pressing **ESC** and  .

Delete all the design memory.

Execute this function when occurring design breakage or impossibility of design input.

If abnormality is found after deleting all the data, replace LCD-T board (or Core module) since the board might be broken.

<NOTE>

All the internal design memory will be deleted by initialization of design memory.

You have to be careful when initializing design memory.

1. Enter maintenance mode in reference to [9-1 How to enter maintenance mode]

2. Press **Memory All Clear** .

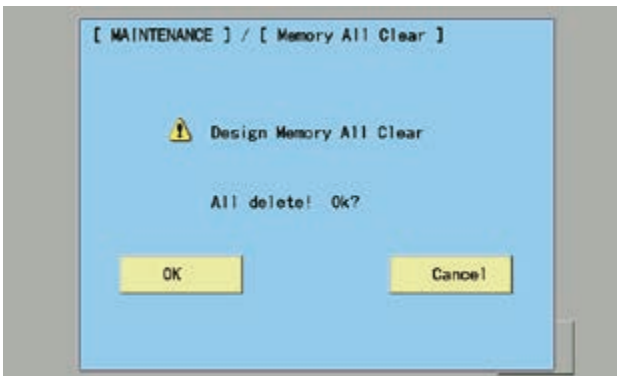

3. Confirmation of free area and all delete will be started after pressing **OK** .

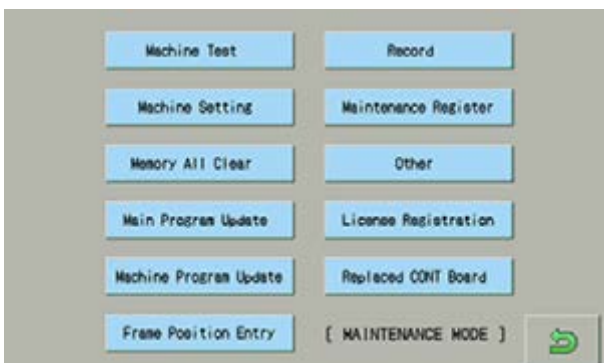

4. Return to drive mode by pressing **ESC** and .

You can confirm history of operation.

- Total number of stitch : Total number of stitch used for embroidery so far
- Error occurrence record : Type of errors and its occurrence date for the last 32 errors
- Occurrence record by error type : Accumulated number of each error occurrence
- Thread break history : The number of thread break by needle bar

Total number of stitch

1. Enter maintenance mode in reference to [9-1 How to enter maintenance mode]

2. Press **Record**.

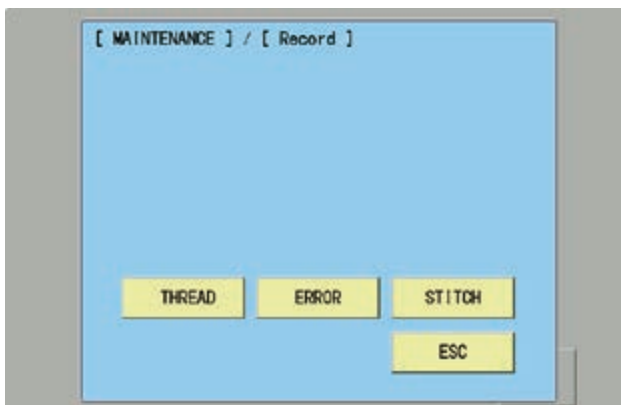

3. Press **STITCH**.

The screen shows total number stitches used for embroidery so far.



4. Selection menu of Clear Total Stitch will be opened when pressing **CLEAR** at Procedure 3.

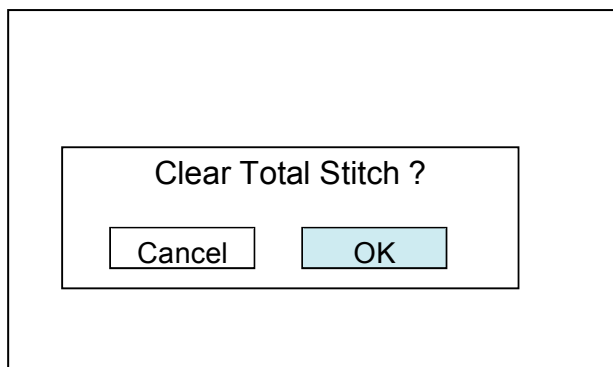

* Total number of stitch is cleared after pressing **OK** and the screen shows one in the procedure 3. Total number of stitch is 0.

* If you do not prefer to clear it, press **Cancel** and the screen shows of the procedure 3 is shown

5. Return to drive mode by pressing **ESC** and .

Record of Error occurrence

4-5-4-2

1. Enter maintenance mode in reference to [9-1 How to enter maintenance mode]

2. Press **Record** .

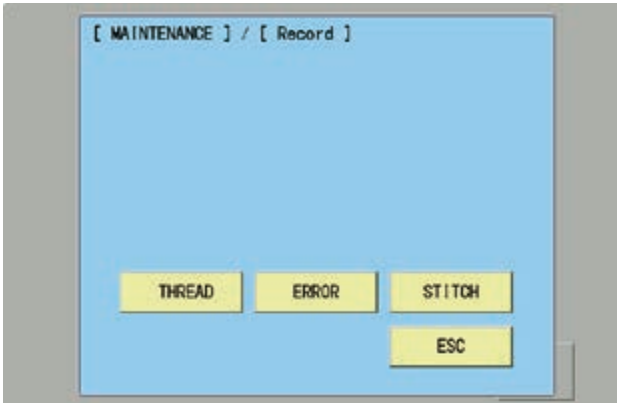

3. Press **ERROR**.

Enable to confirm Record of error occurrence

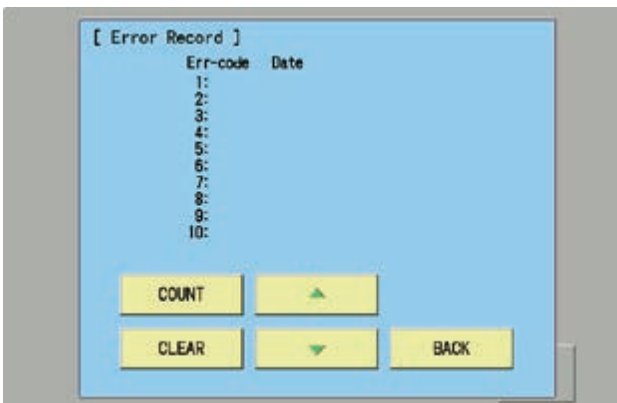

* Enable to confirm Occurrence date and error number of last

32 cases with  button.

Selection menu of Clear Error Record will be opened when pressing **CLEAR**.

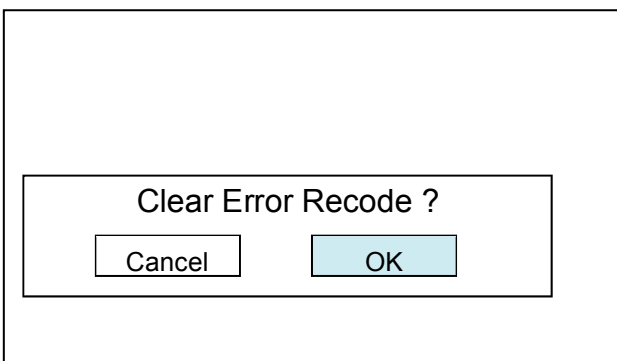

* Error record is cleared by pressing **OK** and the screen of the procedure 3 is displayed.

* If you do not prefer to clear it, press **Cancel** and the screen of the procedure 3 is displayed..

1. Enter maintenance mode in reference to [9-1 How to enter maintenance mode]

2. Press **Record**.

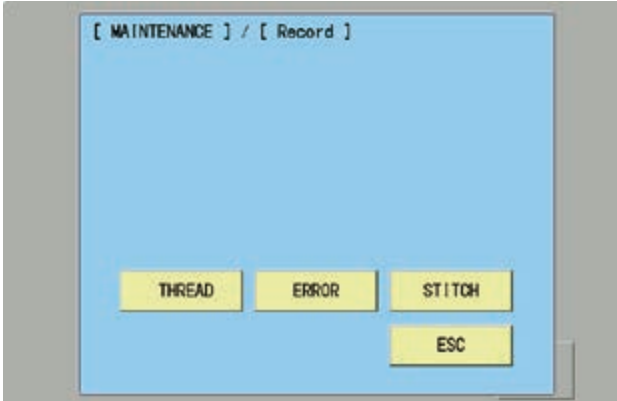

3. Press **ERROR**.

You can confirm record of error occurrence.



4. Press **COUNT**.

You can confirm total number of occurrence in each error.
(E-000 to E-255 will be displayed)

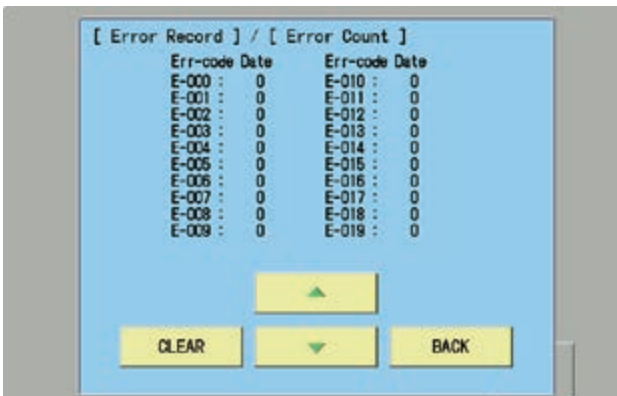

* You can confirm accumulated number for E-000 to E-255



* The screen returns to the previous screen by pressing

BACK.

5. Selection menu of Clear Error Total Count will be opened when pressing **CLEAR** and the screen of procedure 4 is displayed.

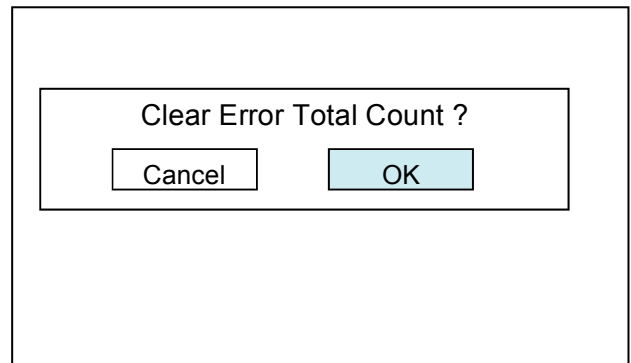

* Error record is cleared by pressing **OK** and the screen of the procedure 4 is displayed.

* If you do not prefer to clear it, press **Cancel** and the screen of the procedure 4 is displayed.

1. Enter maintenance mode in reference to [9-1 How to enter maintenance mode]

2. Press **Record** .

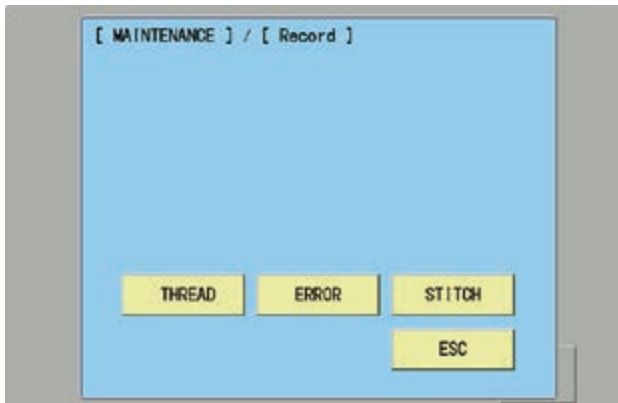

3. Press **THREAD**.

You can confirm thread break history by needle bar.



• *The screen returns to the previous screen by pressing **BACK**.

5. Selection menu of Clear Thread Break Count will be opened when pressing **CLEAR** at the screen of procedure 3.

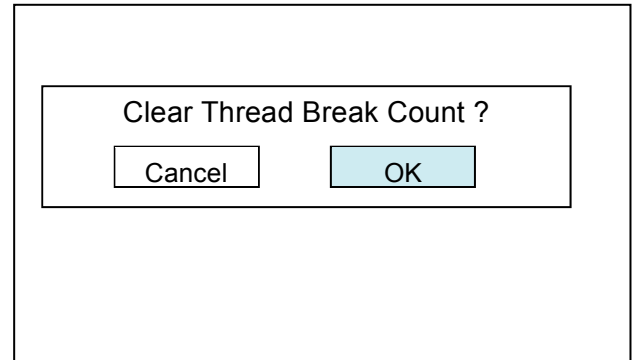

* Thread break history is cleared by pressing **OK** and the screen of the procedure 3 is displayed.

* If you do not prefer to clear it, press **Cancel** and the screen of the procedure 3 is displayed.

1. Enter maintenance mode in reference to [4-4-1 How to enter maintenance mode].

2. Press **Machine Setting**.





3. Select desired number and modify setting.

• Setting values become default by pressing  .

• Page is switched by pressing  .

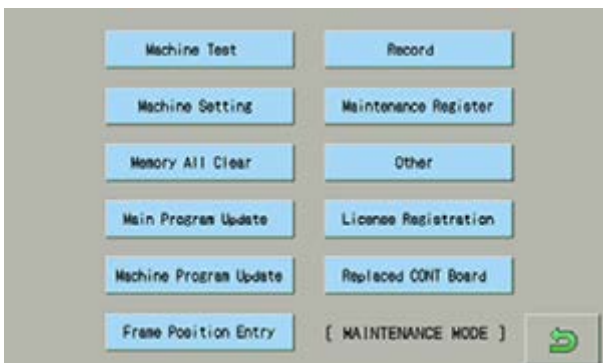
4. Press **ESC** button after modifying of setting number.



5. The screen returns to drive mode by pressing  .

6. Turn off power and on again before use a machine.

Registration of machine maintenance date

When last maintenance date is registered, next regular maintenance date will be set automatically.

1. Enter maintenance mode in reference to [4-4-1 How to enter maintenance mode].
2. Press **Maintenance Register**.



3. Press **Register**.

The current date will be registered as last maintenance date.

When the machine runs more than 2000 hours (default setting) or 365 days are passed after last maintenance, the machine will display the message to have regular maintenance.

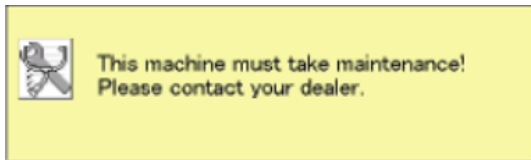

Registered date

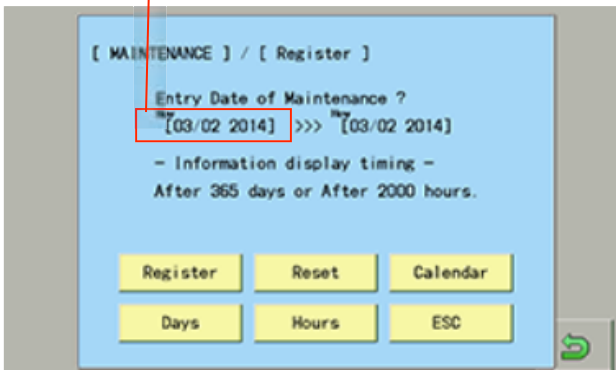

- Pressing the **RESET** button delete the registered date.
- When the **Calendar** button is pressed, you can set calendar of the machine.

- By pressing **Days** button, you can change the number of days for regular maintenance. (1 ~ 3,650 dsys)
- By pressing **Hours** button, you can change the number of running time for regular maintenance. (1 ~ 50,000 hours)

4. Press **ESC**.

Return to maintenance mode.



- End of process.

After exchange CONT board, please activate [Machine Setting Navigation after exchanging CONT board] function. Then you can set necessary machine setting with one process.

4-4-3 Program update

4-4-4 Initializing of machine speed

- Refer to [4-3-2 Preparation for program update] and prepare latest update programs.

1. Insert USB memory that contains data for version up into insertion slot on the control box.
2. Refer to [4-4-1 How to enter Maintenance mode] and enter maintenance mode. The screen shows below:

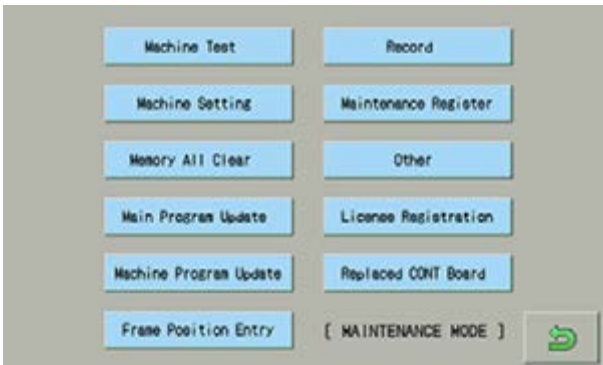

3. Press **Replaced CONT Board**.

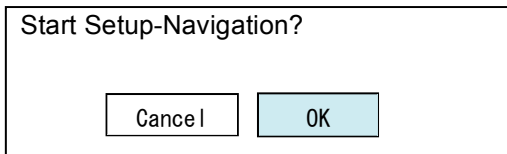

4. Press **OK**.

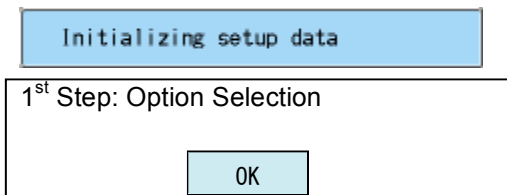

5. Press **Skip**.

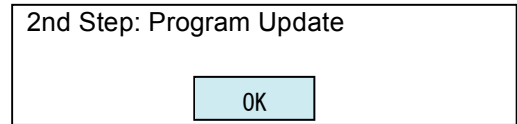

6. Press **OK**.

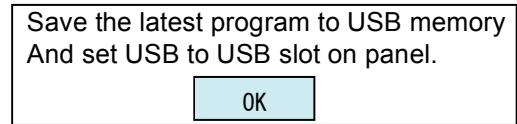

7. Press **OK**.

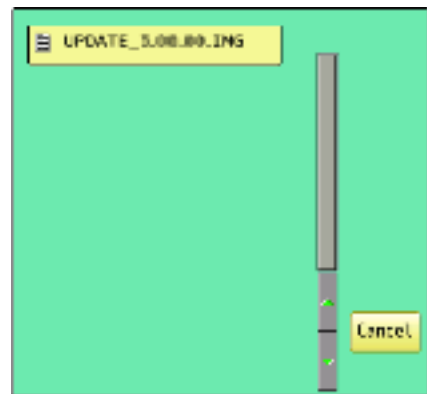

8. Select the file "UPDATE***.IMG"

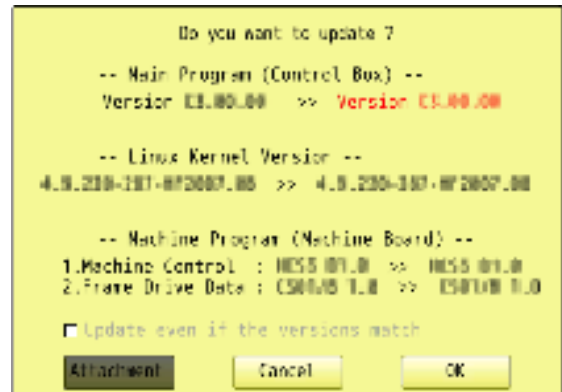

When the version of each program and the version in the update file are different, the version number is displayed in red.

9. When the current machine program is older than latest version, press **OK**.

The installation will be started.

If the current machine program is same or newer version, press **Cancel**.

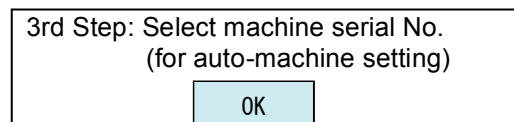

10. Press **OK**.

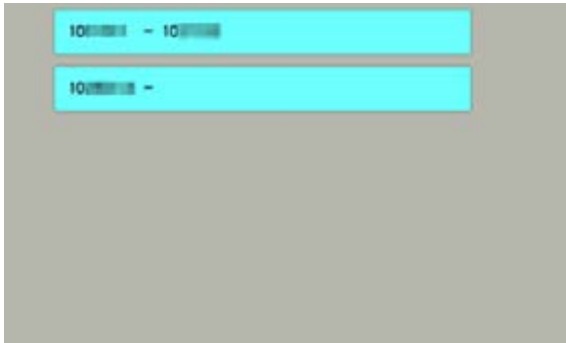

11. Enter the corresponding machine number.

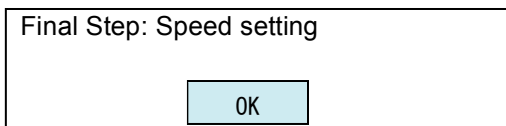

12. Press **OK**.



13. Press **OK**.

[Initializing of machine speed] will be started.
Refer to [Initializing of machine speed] of [4-3-5 Setting of revolution] for more details.

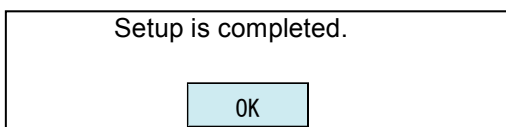

14. Press **OK**.

The screen returns to the maintenance mode.



• End of process.

Electrical connection diagram

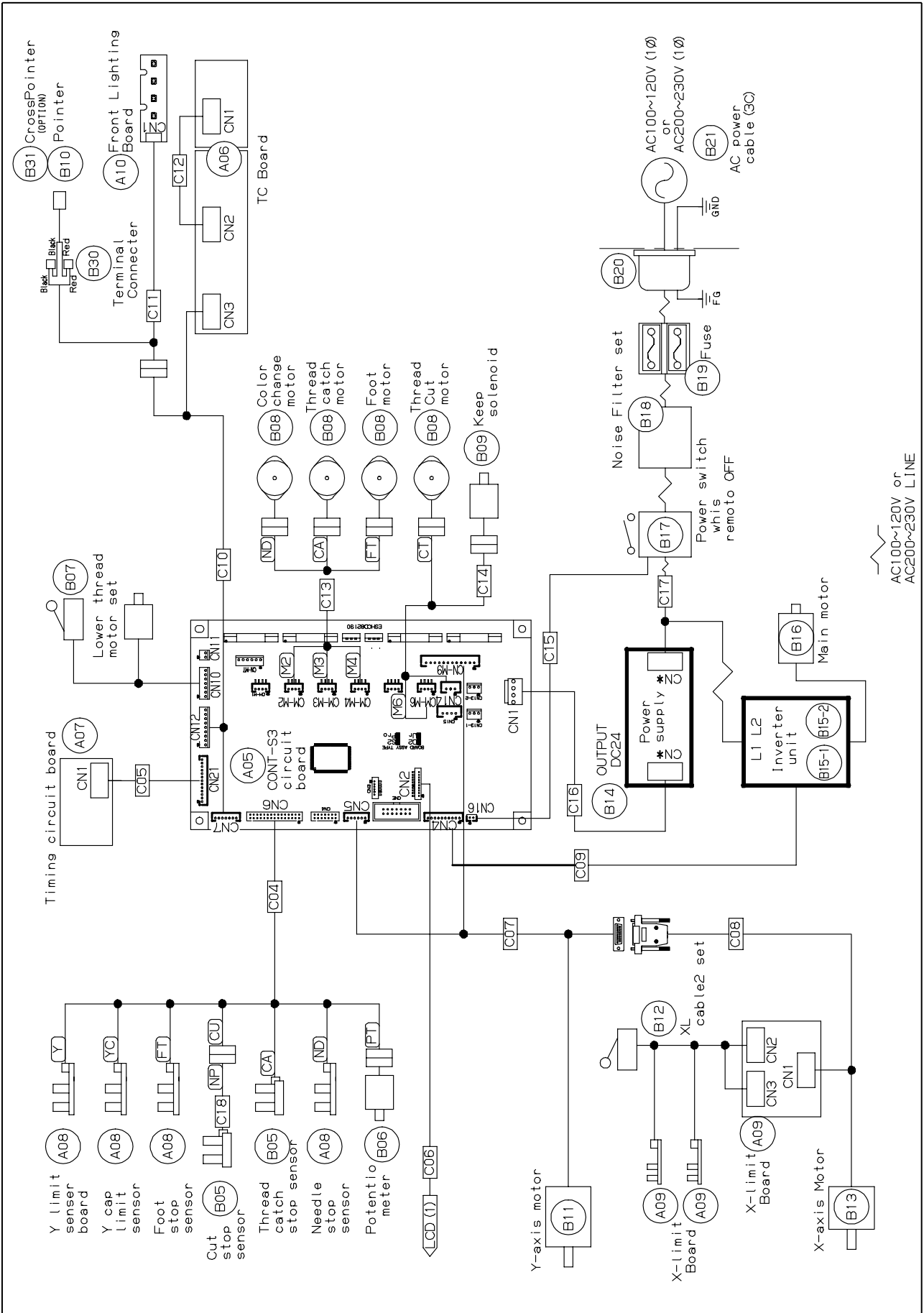

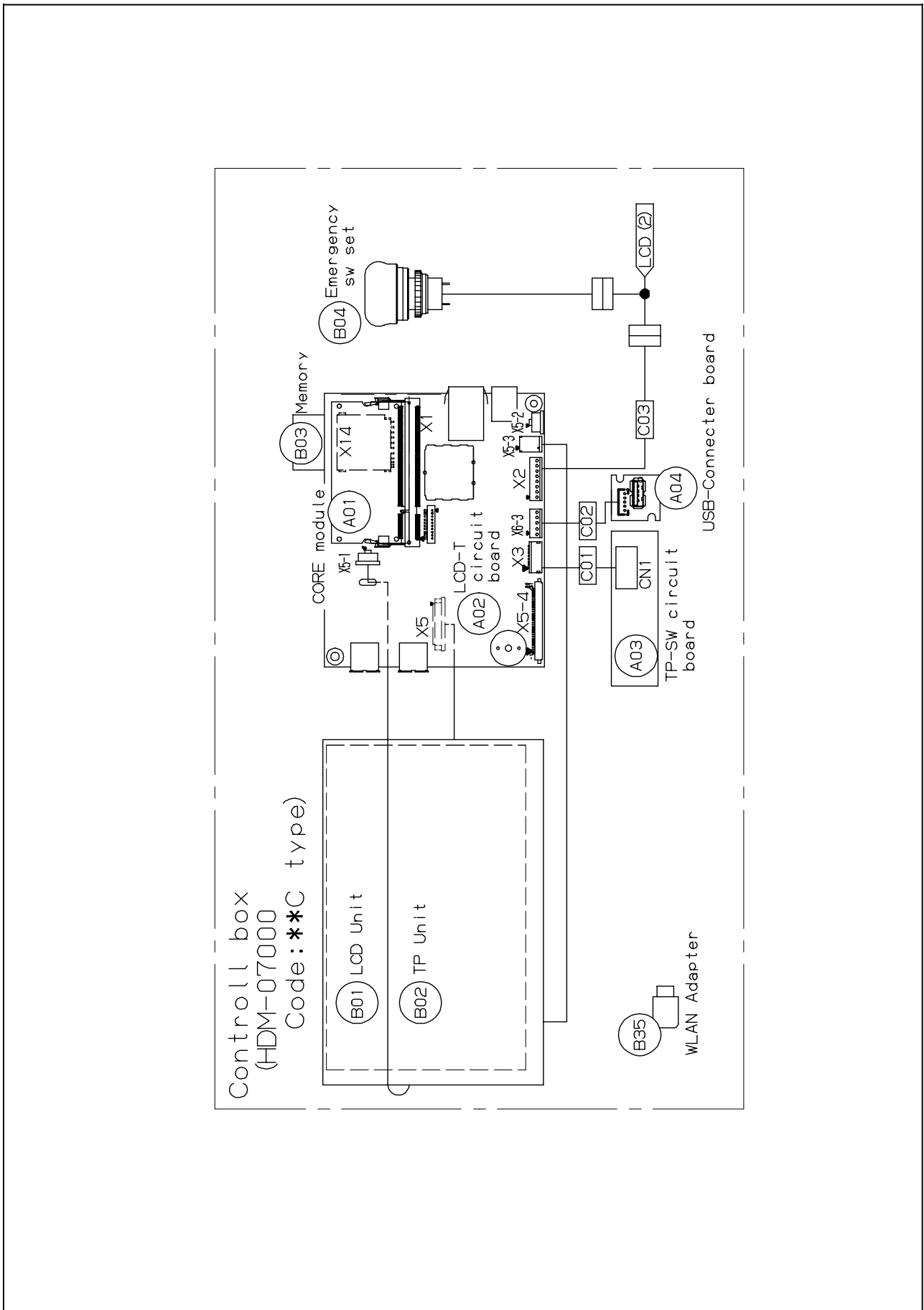

Parts Names	Parts No.	(B11) Y-axis Motor	HCB7921*	(C01) SW harness	HCD7252*	(OPTION)	HCBI2A060
(A01) Cone module	EPZ0187*	(B12) XL cable2 set	HCD7966*	(C02) USB lelay harness	HCD7254*	(B31) Cross pointer	EPZ01880
(A02) LCD-T circuit board	HCD8126*	(B13) X-axis Motor	HCB7920*	(C03) C-BOX harness	HCD7255*	(B35) WLAN Adapter	
(A03) TP-SW circuit board	HCD8116*	(B14) DC Power supply	EPK0146*	(C04) Senser harness	HCB7221*		
(A04) USB connector circuit board	HCB8118*	(B15-1) Input110V type Inverter unit or Inverter unit	HCB7957*	(C05) Timing harness	HCB7209*		
(A05) CONT-S3 circuit board	HCB8120*	(B15-2) Input230V type Inverter unit	HCB7956*	(C06) CONT harness	HCD7272*		
(A06) TC circuit board	HCB8105*	(B16) Main motor 90W	HCB7931*	(C07) XY motor harness	HCB7211*		
(A07) Timing circuit board	HCB8109*	(B17) Power switch remote off	EPS0089*	(C08) X motor lelay harness	HCB7216*		
(A08) sensor circuit board	HCB8111*	(B18) Noise Filter & Fuse Holder	HCB7964*	(C09) INV-S harness	HCB7214*		
(A09) X-limit circuit board	HCB8110*	(B19) Fuse (250V 6A)	EPF0036*	(C10) Front harness	HCB7224*		
(A10) Front lighting circuit board	HCB8116*	(B20) Inlet set	HCB7963*	(C11) Front LED harness	HCB7225*		
(B01) LCD unit	EPZ0149*	(B21) AC power cable (110V) or AC power cable (220V)	EPE0015* (ULTtype) EPE0013* +EPE0003* (PSEtype) EPE0016* (CEEtype) EPE0017* (BFTtype) EPE0018* (T1Stype) HCB7030*	(C12) TC relay harness	HCB7215*		
(B02) TP unit	EPZ0148*	(B21) AC power cable (220V)		(C13) Motor harness	HCB7210*		
(B03) Memory card	EPZ0122*	(B30) Terminal Connector	EPF00710	(C14) KEEPER-J harness	HCU7010*		
(B04) Emergency sw set	HCD7945*			(C15) PD harness	HCB7204*		
(B05) Photo sensor	EPF0052*			(C16) DC harness	HCB7202*		
(B06) Potentiometer	HCB7960*			(C17) Power relay harness	HCB7202*		
(B07) Lower Thread motor set	HCB7962*			(C18) Senser relay harness	HCU7012*		
(B08) PM-motor	HCD7951*						
(B09) Keep solenoid	HCD7939*						
(B10) Laser pointer	HCB7969*						
Attention •Inverter •AC power cable Product varies in a power supply to use							

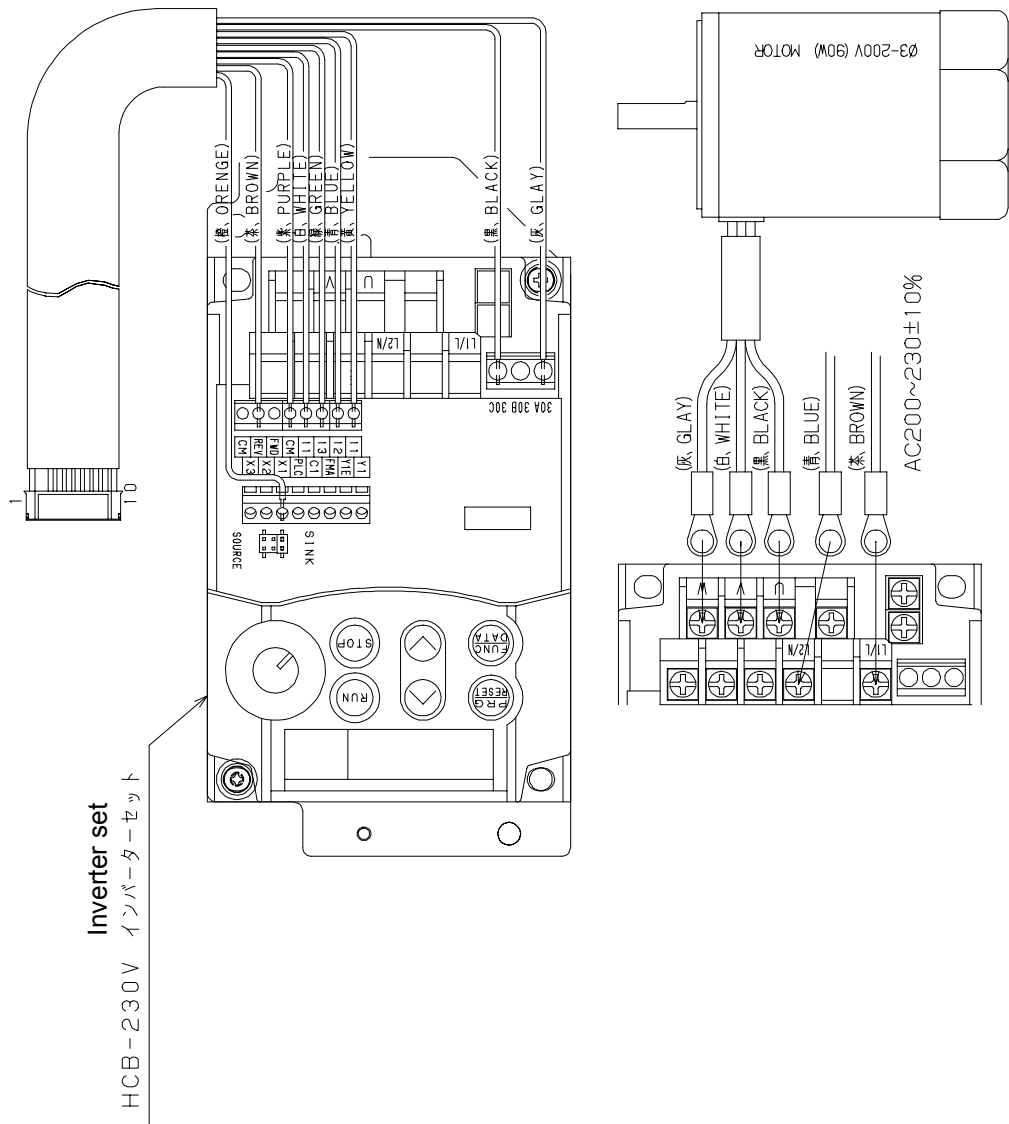

Explanation of function of circuit board

HCD8126*

LCD-T board Ass'y

Parts side

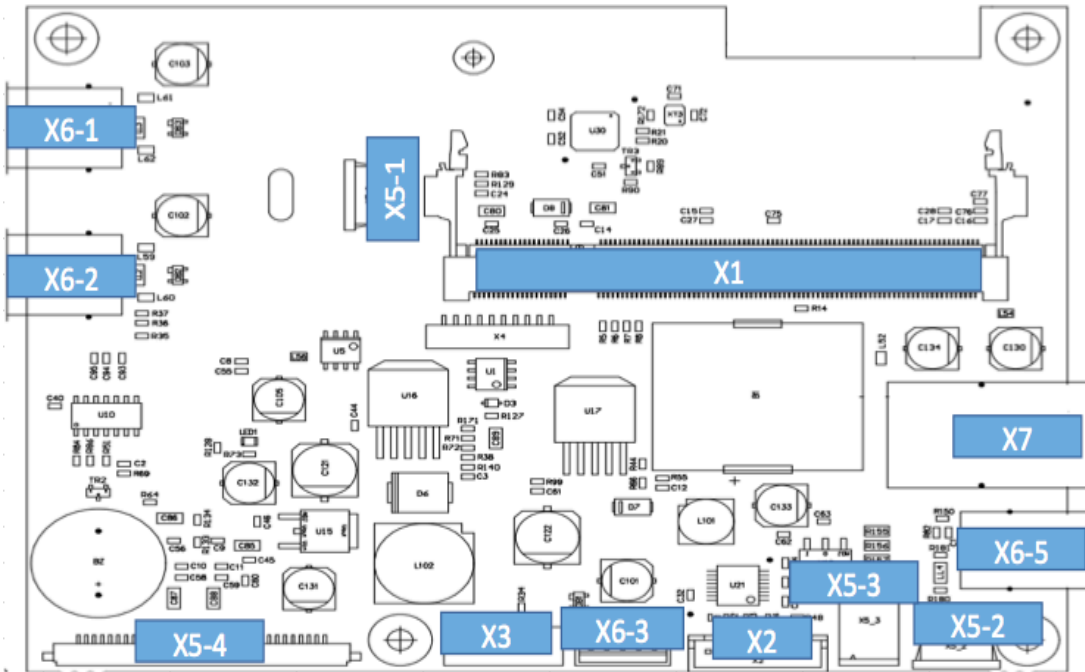

Back side

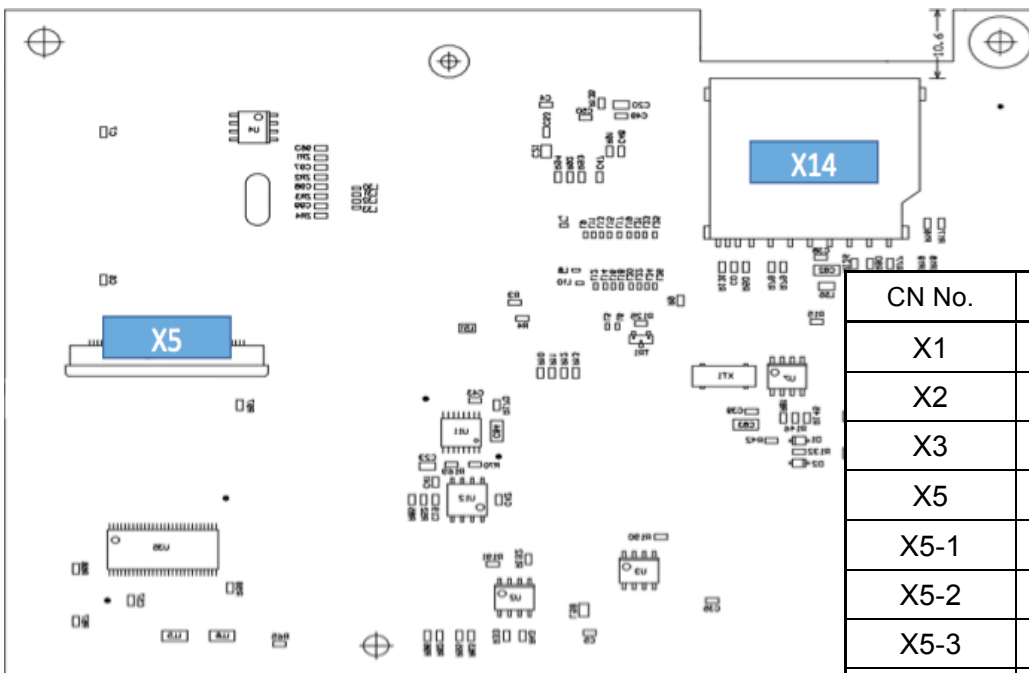

CN No.	Function
X1	Core module I/F
X2	Machine CPU I/F
X3	TP-SW board I/F
X5	7in LCD I/F
X5-1	7in touch panel input
X5-2	10.4in touch panel input
X5-3	USB-A connector 3
X5-4	10.4in LCD I/F
X6-1	USB-A connector 1
X6-2	USB-A connector 2
X6-3	7in LCD backlight output
X6-5	USB-B connector
X7	LAN
X14	SD card

HCB8118*

USB connector board ass'y

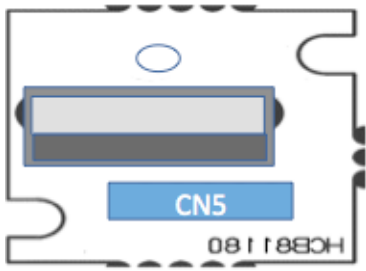

CN No.	Function
CN5	USB input

HCD8116*

TP-switch board ass'y

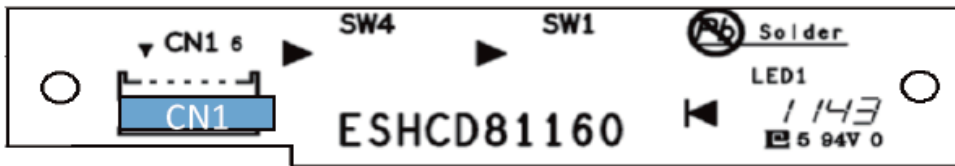

CN No.	Function
CN1	Switch output, LED input

HCB8120*

CONT-S3 Circuit Board Ass'y

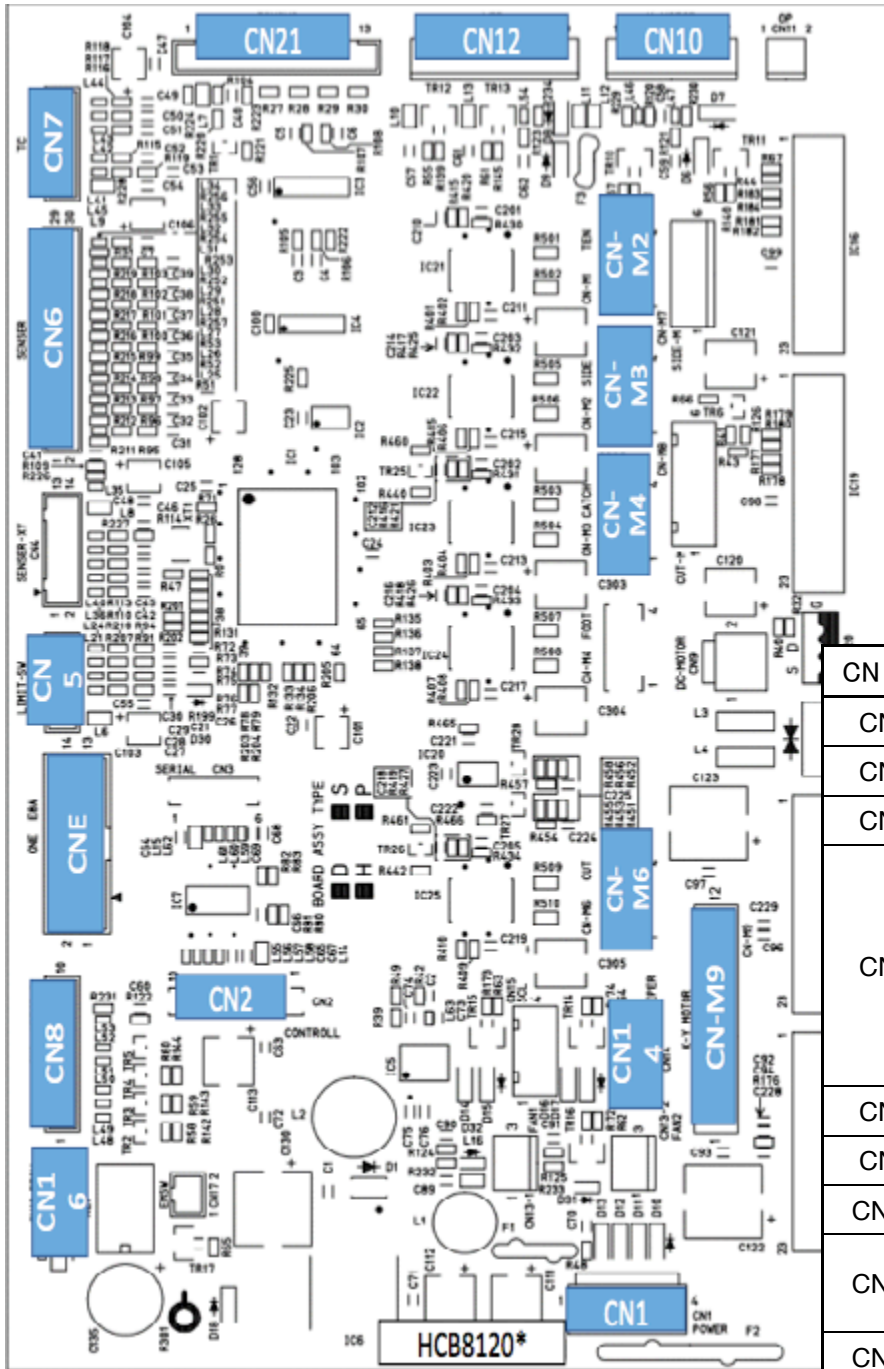

CN No.	Function
CN1	Input of 24V power source
CN2	Control box I/F
CN5	X-Y position sensor I/F
CN6	Input of Thread catcher, Needle bar change, Thread cutting orig sensor Needle bar change potensionmeter
CN7	T/C sensor I/F
CN8	Inverter I/F
CN10	Bobbin winder motor output
CN12	Laser pointer output, Front LED output
CN14	Keeper solenoid output
CN16	Main switch remote output
CN21	Input of C point, L point, Main shaft angle
CN-M2	Needle bar change motor output
CN-M3	Output of Thread catch motor
CN-M4	Pressure foot motor output
CN-M6	Thread cutting motor output
CN-M9	X-Y motor output
CNE	AUX

HCJ8106*

SENSOR Circuit Board Ass'y

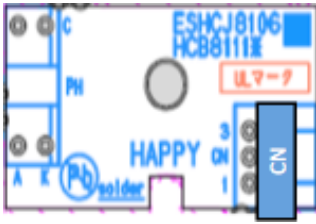

CN No.	Function
CN	Sensor output

HCR8129*

FRONT LED Circuit Board Ass'y

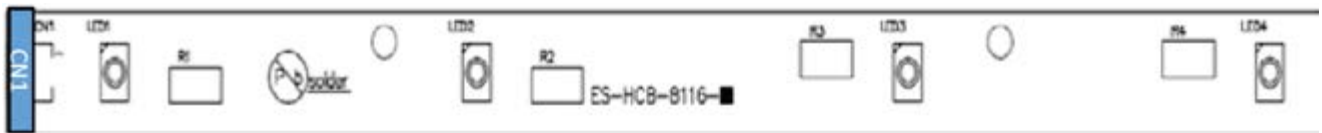

CN No.	Function
CN1	24V power source input

HCB8110*

X limit sensor board ass'y

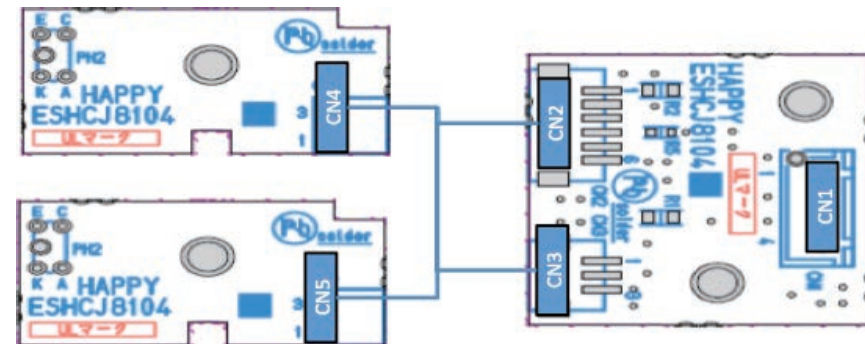

CN No.	Function
CN1	Sensor value output
CN2	Sensor input
CN3	Sensor input
CN4	Sensor output
CN5	Sensor output

How to respond for some question (As example step)

*When you receive some question from customer, please use this step for sold problem as sample.

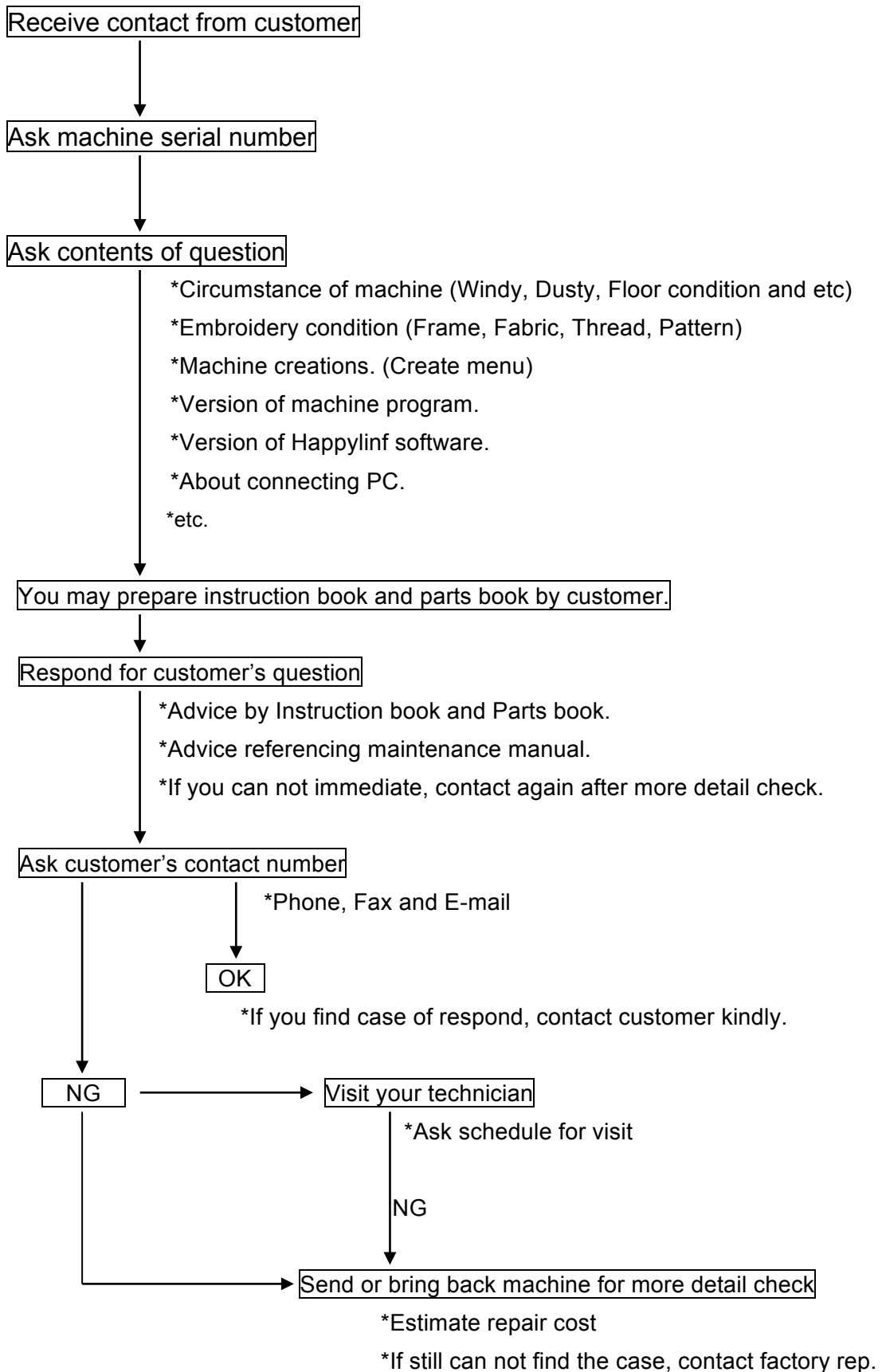

Trouble shooting(Electricity doesn't turn on)

7-2-1

Trouble	Factor	Cause of trouble and measure	Page
Electricity doesn't turn on	Mechanical	1. Did fuse blow? 1-1 If it did, replace it.	
		2. Check of defect on board. 2-1 Replace of CONT-** board ass'y. 2-2 Replace of LCD- ** board ass'y.	
		3. No problem in power supply? 3-1 Check and adjust the correct voltage. 3-2 Try to replace power supply.	4-1-3
		4. Check of Cable catching causes short-circuit. 4-1 Please insulate the cable after removing outer cover. 4-2 Replace of cable.	
		5. Confirm not getting power supply from same outlet with other embroidery machine or other machines which contains motor. 5-1 Preferably only 1 embroidery machine should be connected with 1 outlet. (Maximum 2-3machines)	
	Operator	1. Didn't press emergency switch? 1-1 Release lock.	(3-8)
Environment	1. Is electricity in receptacle? 1-1 Supply power.		

() ---Reference instruction book

Trouble shooting(Thread break)

7-2-2

Trouble	Factor	Cause of trouble and measure	Page
Thread break	Mechanical	1. Is needle drop unstable by vibration? 1-1 Reconsider where to install the machine. 1-2 Move the machine to floor fully reinforced. 1-3 Use strong table to be able to endure vibration.	(2-5)
		2. No burr or scratch in thread guide hole? 2-1 Remove burr and scratch. 2-2 Replace of thread guide.	3-1-1
		3. No problem in thread adjusting spring? 3-1 Replace spring if it doesn't spring. 3-2 If weak or broken, replace it.	3-1-1
		4. Does detecting roller make smooth turn? 4-1 Clean inside hole of bearing. 4-2 Correct so as for slit disc not to touch sensor. 4-3 Correct so as for cable not to touch slit disc. 4-4 Check cable of TC 7 Board is unconnected	4-2-2
		5. No problem in thread guide unit and thread tension ass'y? 5-1 Remove burr and scratch if appeared. 5-2 Remove lints and clean.	3-1-1
		6. Does disc on thread tension ass'y. turn smoothly? 6-1 Remove lints and clean. 6-2 Replace	3-1-1
		7. Is backlash between take-up lever and take-up crank roller not bigger? 7-1 Replace of take-up lever.	3-3-9
		8. No problem in needle holder? 8-1 Remove burr and scratch. 8-2 Make proper fixing. (direction)	3-1-2
		9. No burr and scratch on needle plate? 9-1 Remove burr and scratch in needle hole. 9-2 Remove burr and scratch around needle hole on back of needle plate. 9-3 Replace it if not furbished. 9-4 If furbishing made needle hole wider, replace it.	3-1-1
		10. No problem in pressure foot? 10-1 Remove burr and scratch. 10-2 Correct bent. 10-3 Adjust height. 10-4 Replace of pressure foot. 10-5 Replace of pressure foot drive cam.	3-1-1 3-1-1 3-2-10 3-2-11 3-2-9

Trouble	Factor	Cause of trouble and measure	Page
Thread break	Mechanical	11. No problem in rotary hook? 11-1 Clean it to remove lints. 11-2 Furbish scratch. 11-3 If backlash of bobbin case holder and outer hook grows bigger, replace them. 11-4 Replace.	3-1-1 (23-2) 3-5-1
		12. No problem in rotary hook retainer? 12-1 Remove burr and scratch. 12-2 Adjust position.	 3-5-2
		13. No problem in needle? 13-1 Fix it properly . 13-2 Select proper size of needle to match thread thickness. 13-3 If tip of needle is warped or bent, replace. 13-4 Replace.	 3-1-2 3-1-4 3-1-1
		14. No problem in bobbin case? 14-1 Remove rust and scratch. 14-2 If thread guide spring is off, replace it.	
		15. No problem in bobbin? 15-1 Remove scratch (iron bobbin). 15-2 If distorted. replace it.	
		16. Is needle bar spring not broken? 16-1 Replace it.	 3-3-7
		17. Does needle bar make smooth movement? 17-1 If bent, replace it.	 3-3-7
		18. No backlash in moving head? 18-1 Adjust positioning roller shaft.	 3-3-2
		19. Needle doesn't drop in the center of needle hole. 19-1 Adjust positioning plate and adjust needle drop back and forth. 19-2 Adjust position of needle selection unit, then adjust needle drop right and left.	3-3-4 3-4-1
		20. Is the lowest needle position proper? 20-1 Adjust mechanical lowest needle position. 20-2 Adjust electric lowest needle position.	3-2-3 4-2-1
		21. Is needle height proper? 21-1 Adjust as specified.	 3-3-6
		22. Is rotary hook timing proper? 22-1 Adjust as specified.	 3-5-1
		23. Is clearance between needle and rotary hook proper? 23-1 Adjust as specified.	 3-5-1

Trouble shooting(Thread break)

7-2-2

Trouble	Factor	Cause of trouble and measure	Page
Thread break	Mechanical	24. Check tip of keeper hit the bobbin case. 24-1 Adjust it regularly.	3-6-12
		25. Is take-up lever timing proper ? 25-1 Adjust as specified.	3-2-8
		26. No problem in timing belt? 26-1 Adjust tension. 26-2 If scratched or damaged, replace it.	3-8-1 3-8-2
		27. No problem in motor belt? 27-1 Adjust tension. 27-2 If scratched or damaged, replace it.	3-8-3 3-8-4
		28. Is revolution setting proper? 28-1 Make automatic speed setting.	(25-2) 4-4-4
		Operator	1. Operation is wrong (no proper [create] setting for sewing?) 1-1 Tell how to operate.
		2. Is pattern dwindled too much by pattern adjustment? 2-1 Adjust size so as to produce less thread break. 2-2 Use pattern edited again (density_ change).	
		3. Is thread tension properly set? 3-1 <Upper thread> Considering sewing finish, set tension. 3-2 <Bobbin thread> Considering upper thread tension, set tension.	(8-1) (4-5)
		5. Is bobbin put in bobbin case properly? 5-1 Viewing from front of bobbin case, set so that bobbin turns left-wise.	(4-5)
		6. Does thread cone stand properly? 6-1 Keep thread from hitting felt. 6-2 Stand vertically.	(4-6)
		7. Is passing of thread proper? 7-1 Pass thread properly.	(4-7)
		8. Is cloth properly stretched? 8-1 No loosening and no too much tightening. Even tension in depth and width. 8-2 Texture should be even in direction of X and Y.	(6-2) (7-5)
		9. Is frame properly set? 9-1 Frame should be put in positioning hole on tubular-frame. 9-2 No loosening of screw.	(6-3) (7-6)

() ---Reference instruction book

Trouble shooting(Thread break)

7-2-2

Trouble	Factor	Cause of trouble and measure	Page
Thread break	Operator	10. Is frame used to suit pattern size? 10-1 Use frame to suit pattern size.	
		11. When you dispose of thread (thread remains around rotary hook), didn't you damage rotary hook, needle plate with scissors? 11-1 Tell to dispose of thread carefully. 11-2 Open needle plate to dispose of thread.	
		12. Didn't you neglect cleaning and oiling? 12-1 Tell to always clean and use cleanly. 12-2 Tell to oil regularly.	(23-2) (23-1)
	Thread & cloth	1. Is thread used to suit needle size? 1-1 Use thread to suit needle size.	3-1-4 (4-2)
		2. Is thread used to suit embroidery? (thread twist, tender thread). 2-1 Don't use too strongly twisted thread. 2-2 Twist of thread is to be left-wise. 2-3 Use tender thread. 2-4 Don't use thread with knot or uneven size.	3-1-3 (4-2)
		3. Is thread properly wound against cone? 3-1 Use thread to be wound smoothly.	
		4. Isn't tip of cone warped or isn't thread caught in scratch? 4-1 Remove warp and scratch.	
		5. Don't use thread left for a long period? (inferior thread). 5-1 Don't buy thread more than you use. 5-2 Tell not to store thread for a long period. 5-3 Tell how to store. (direct sunshine. humidity dust etc.)	
		6. Isn't poor unwoven cloth used? Is number of sheets used proper?	
	Environment	1. Is strength of table and floor enough? 1-1 Reconsider place to install the machine. 1-2 Move the machine to place where floor is strong enough. 1-3 Use table with strength endurable against vibration.	(2-5)
		2. Are room temperature and humidity proper against thread? 2-1 It is desirable to install air conditioner to keep temperature and humidity in a certain level.	(23-1)
		3. Doesn't embroidery machine receive direct sunlight? (cause of inferior thread) 3-1 See not to expose to sunlight (spread curtain)	(2-6)

() ---Reference instruction book

Trouble shooting(Thread break)

7-2-2

Trouble	Factor	Cause of trouble and measure	Page
Thread break	Environment	4. Is there something that produce steam, wasted cotton, dust around. the embroidery machine? 5-1 Keep the embroidery machine off those things.	(2-6)
		5. Does thread go out of control by taking wind from outside or heater etc.? 6-1 Keep the embroidery machine off such wind. 6-2 Move the embroidery machine to proper place.	(2-6)
	Pattern	1. Does thread break occur repeatedly at same place in design? 1-1 Check pattern to modify punching.	
		2. Is it too narrow between stitches? 2-1 Check pattern to modify punching. 2-2 Setting of [create] menu. (Stitch sweep)	(10-3)
		3. Too many empty stitches? 3-1 Make [create] setting. (this setting doesn't read empty stitches)	(10-3)
	Others	1. Using spray paste (adhesive material) 1-1 Clean around rotary hook.	3-1-2
		1-2 Replace or clean needle.	(23-2)
		1-3 Use this paste at a given place and never use in front or back of the embroidery machine.	(4-1)

() ---Reference instruction book

Trouble	Factor	Cause of trouble and measure	Page
Erroneous thread cut (E-190) (E-193)	Mechanical	2. Isn't rubbing of fixed knife and moving knife weak? 2-1 Adjust to be able to rub properly.	3-6-8
		3. Does moving knife make smooth move? 3-1 Check if rubbing of moving knife and fixed knife is not too strong.	(23-3) 3-6-8
		4. Check Displace of moving knife. 4-1 Adjust of moving knife position.	3-6-9
		5. Check defacement of moving knife or fixed knife. 5-1 If possible, furnish with file. 5-2 Replace	3-6-6 3-6-7
		6. No backlash in up and down direction of knife drive shaft? 6-1 Check no loosening of screw on moving knife. 6-2 Check no loosening of screw on knife drive shaft.	3-6-8
		7. No backlash in fixed knife? 7-1 Check no loosening of screw on fixed knife.	3-6-8
		8. Does thread cut pulse motor work properly? 8-1 Check cable. 8-2 If trouble found in CONT-** board ass'y, replace. 8-3 If trouble found in thread cut pulse motor, replace.	
		9. Is number of revolution proper at time of thread cut? 9-1 Make automatic speed setting. 9-2 If trouble in CONT-** board, LCD- ** board ass'y, replace.	(25-2) 4-4-4
		10. Is there no skipped stitch? 10-1 Adjust needle depth. 10-2 Adjust clearance between needle and rotary hook. 10-3 Is height of pressure foot proper? 10-4 Is rotary hook timing proper? 10-5 Is relation between needle and thread proper?	3-3-6 3-5-1 3-2-10 3-5-1

() ---Reference instruction book

Trouble shooting(Erroneous thread cut)

7-2-3

Trouble	Factor	Cause of trouble and measure	Page
Erroneous thread cut (E-190) (E-193)	Mechanical	11. Check the needle bar moves up and down during thread cut. 11-1 Adjust position of jump device. 11-2 Replace needle bar cushion. 11-3 Replace needle bar driver.	3-2-5 3-3-7 3-2-4
		12. Is position of keeper proper? 12-1 Adjust the fixed position regularly.	3-6-12
		13. Check the movement of keeper goes smoothly. 13-1 Readjust if it is not smooth.	3-6-12
	Operator	1. No negligence in cleaning thread cut device? 1-1 Tell to clean regularly. # It's desirable to prepare brush with soft hair and air gun.	(23-2)
		2. Is timing of thread tension proper? 2-1 <Upper thread> Considering sewing finish, set tension. 2-2 <Bobbin thread> Considering upper thread tension, set tension.	(8-1) (4-5)
	Environment	1. Are power and voltage rated and stable? 1-1 Supply rated voltage.	
	Thread & cloth	1. Is twist of thread too strong? 1-1 Use thread with proper twist.	
		2. No skipping by use of lots of paste? 2-1 Use small amount of paste. 2-2 Remove paste stuck to needle.	

() ---Reference instruction book

Trouble shooting(Off-registration of pattern)

7-2-4

Trouble	Factor	Cause of trouble and measure	Page
Off-registration of pattern	Mechanical	1. Does frame move smoothly? 1-1 Avoid curling of thread and cloth. 1-2 Reinstall of outer cover in case of touch with outer cover. 1-3 Adjust with no clearance between Arm and Connecting plate B.	2-1
		2. Is bound of frame base too big? 2-1 Fix frame base between bearing and base without gap.	(6-1b)
		3. Is carriage belt tension proper? 3-1 Adjust all belts as specified.	3-7-1 3-7-3
		4. No loosening of screws on carriage drive? 4-1 Check screw. If loosened, tighten firmly.	
		5. No lints or dust around idler pulley on carriage? 5-1 Clean	
		6. No damage in carriage belt? 6-1 If damaged, replace.	3-7-2 3-7-4
		7. No backlash of back and forth in moving head? 7-1 Adjust positioning roller shaft to remove backlash back and forth.	3-3-2
		8. Is height of pressure foot proper? 8-1 Adjust as specified.	3-2-10
		9. No problem in motion of pulse motor for X/Y carriage ? 9-1 Check wiring. If screw got loosened, tighten more. 9-2 After 9-1, still problem, then replace.	
		10. No problem in motion of CONT-** board ass'y ? 10-1 Check wiring. If screw got loosened, tighten more. 10-2 After 10-1, still problem, then replace.	
		11. Doesn't other frame than genuine one used? 11-1 If frame is too heavy, don't use it. 11-2 If setting is not proper, set it so as not to move.	
		12. No problem in LCD-** board ass'y ? 12-1 Try to initialize. 12-2 Replace of LCD- ** board ass'y.	4-1-1
		13. Is number of revolution proper? 13-1 Make automatic speed setting.	(25-2) 4-4-4
		14. Not affected by noise? 14-1 Don't use the machine near where noise is generated.	
	Operator	1. Is setting of frame correct? 1-1 Frame should be put in positioning hole on tubular frame. 1-2 Set so as for screw not to loosen.	(6-3) (7-6)

() ---Reference instruction book

Trouble shooting(Off-registration of pattern)

7-2-4

Trouble	Factor	Cause of trouble and measure	Page
Off-registration of pattern	Operator	2. Is cloth properly stretched. 2-1 Stretch properly.	(6-2) (7-5)
		3. Is thread tension proper? 3-1 Observing sewing rhythm, set thread tension properly.	(4-5) (8-1)
		4. Was the machine left for a long time in middle of sewing? 4-1 Try to finish sewing as soon as possible.	
	Environment	1. Is strength of table and floor enough? 1-1 Check where to place the machine again. 1-2 Move to where floor is strong enough. 1-3 Use strong table to be able to endure vibration.	(2-5)
		2. No problem in CONT-** board ass'y by low power and voltage (variation)? 2-1 Supply rated voltage. 2-2 Use transformer. 2-3 Use stabilizer.	
		3. Is there no place where noise is generated near the machine? 3-1 Don't use the machine near where noise is generated.	
		4. Doesn't drive frame hit obstacle? 4-1 Remove obstacle. 4-2 When using cap frame, see not to hit table.	(2-5) (2-6)
	Thread & cloth	1. Not using shrinkable cloth? 1-1 Use backing paper (consider number of sheets to use).	(4-3)
		2. Isn't breakable cloth is used by thread tightening? 2-1 Use backing paper (consider number of sheets to use).	(4-3)
		3. Is proper backing paper used? 3-1 Use backing paper to match cloth.	(4-3)
		4. Isn't cloth (embroidery) too heavy? 4-1 Don't use extremely heavy cloth.	
	Pattern	1. Pattern data may be destroyed. 1-1 Read again. 1-2 Let new pattern read.	(5-4) (5-5)
		2. Memory pattern was destroyed. 2-1 Let new pattern read.	(5-4) (5-6)
		3. No problem in USB memory ? 3-1 Initialize and read again. 3-2 Prepare new USB memory.	

() ---Reference instruction book

Trouble shooting(Upper thread comes off from needle hole)

7-2-5

Trouble	Factor	Cause of trouble and measure	Page
Upper thread comes off from needle hole	Mechanical	1. Is keeper in motion? 1-1 Check if cable was cut or there is something unusual. 1-2 In case solenoid is in trouble, replace. 1-3 In case CONT-** board ass'y is in trouble, replace.	3-6-11
		2. Is keeper put in right place? 2-1 Put it as specified. 2-2 Modify bent of keeper. 2-3 Adjust it again if movement is not smooth.	3-6-12
		3. Is magic-tape on thread catch holder not worn? 3-1 Replace magic-tape.	3-3-14
		4. Does bobbin thread holder hold bobbin thread? 4-1 Adjust pressure when contacting moving knife. 4-2 In case bobbin thread holder is in trouble, replace. 4-3 Clean bobbin thread holder.	3-6-10
		5. No error in thread cut (2 threads cut)? 5-2 Position moving knife as specified. 5-3 Check and polish burr or scratch on moving knife. 5-4 In case moving knife is in trouble, replace.	3-6-9 3-6-6
		6. Are clearance between needle and rotary point and needle height are proper? 6-1 Adjust clearance between needle and rotary hook as specified. 6-2 Adjust needle depth.	3-5-1 3-3-6
		7. Doesn't thread catch hook cut upper thread? 7-1 Polish burr on hook. 7-2 In case hook is in trouble, replace.	
		8. Does thread catch hook hold upper thread? 8-1 Check if cable was cut or there is something unusual. 8-2 In case pulse motor is in trouble, replace. 8-3 Adjust fixing position. 8-4 If hook is bent, modify. 8-5 In case hook is in trouble, replace. 8-6 In case CONT-** board ass'y is in trouble, replace.	3-2-18
		9. Check tension of thread adjusting spring is too weak. 9-1 Adjust of tension.	3-3-11

Trouble shooting(Upper thread comes off from needle hole)

7-2-5

Trouble	Factor	Cause of trouble and measure	Page
Upper thread comes off from needle hole	Mechanical	10. Check the needle bar moves when start sewing. 10-1 Adjust position to fix jump device. 10-2 Replace needle bar driver.	3-2-5 3-2-4
		11. Is number of revolution proper when sewing started? 11-1 Make automatic speed setting.	(25-2) 4-3-5
		12. Is height of pressure foot proper? 12-1 Adjust as specified.	3-2-10
		Operator	1. Isn't thread tension too strong? 1-1 Weaken tension not to cause trouble in sewing rhythm.
	2. Keen in cleaning thread cut device? 2-1 Clean bobbin thread holder regularly.		(23-3)
	3. Is setting of bobbin thread proper? 3-1 Pass thread on bobbin thread guide surely.		(4-5)
	4. Is bobbin thread properly wound? 4-2 Pull out bobbin thread to check if it comes out smoothly.		(4-4) (4-5)
	5. Is upper thread properly passed? 5-1 Pass properly again.		(4-6) (4-7)
	6. Does thread cone stand properly? 6-1 Keep thread from hitting felt. 6-2 Stand vertically.		(4-6)
	7. Is [create] properly set? 7-1 Select longer setting of upper thread length. 7-3 Select start lock stitch [effective].		(15-1)
	Thread & Cloth	1. Is thread used to suit embroidery? (thread twist, tender thread). 1-1 Don't use too strongly twisted thread. 1-2 Twist of thread is to be left-wise. 1-3 Use tender thread. 1-4 Don't use thread with knot or uneven size.	3-1-3
		Environment	1. Does wind let thread go beyond control? (outside wind, heater, and fan etc.) 1-1 Keep the embroidery machine off from wind.
	2. Is voltage of power as rated and stable? 2-1 Supply rated voltage.		
	Pattern	1. Is there stop sewing stitch for start sewing? 1-1 Modify pattern. 1-2 Set lock stitch function.	(15-5)

Trouble shooting(Upper thread remains)

7-2-6

Trouble	Factor	Cause of trouble and measure	Page
Upper thread remains	Mechanical	1. Upper thread is difficult to come out of keeper at time of thread cut (bent or warp etc.). 1-1 Modify bent or warp. 1-2 Replace keeper.	
		2. Keeper doesn't return properly at time of thread cut. 2-1 Modify bent of keeper. 2-2 Adjust position to fix. 2-3 Adjust it again if movement is not smooth.	3-6-12
		3. Upper thread does not come off from magic tape of thread holder. 3-1 Insert something(Thickness 0.1-0.2mm) into holder then move it right and left to put magic tape in order. 3-2 Replacement of magic tape.	3-3-14
		4. Doesn't thread catch hook cut upper thread? 4-1 Polish burr on hook. 4-2 In case hook is in trouble, replace.	
	Operator	1. Setting of thread tension is weak. 1-1 Strengthen so as not to cause trouble in sewing rhythm.	(4-5) (8-1)
		2. Is [create] properly set? 2-1 Select length of upper thread [standard].	(15-1)
	Thread & cloth	1. Using hard cloth make thread difficult to go through. 1-1 Select needle and thread.	3-1-4
		2. Using thick cloth make thread difficult to go through. 2-1 Select needle and thread.	3-1-4
		3. Is thread used to suit embroidery? (thread twist, tender thread). 3-1 Don't use too strongly twisted thread. 3-2 Twist of thread is to be left-wise. 3-3 Use tender thread. 3-4 Don't use thread with knot or uneven size.	3-1-3 (4-2)

() ---Reference instruction book

Trouble shooting(Malfunction of thread break detection)

7-2-7

Trouble	Factor	Cause of trouble and measure	Page
Malfunction of thread break detection (empty detection)	Mechanical	1. Trouble in turning detection roller. 1-1 Clean roller shaft holder. 1-2 Check if slit disc doesn't contacts sensor. 1-3 Clean sensor if dust gets stuck. 1-4 Check if cord doesn't contacts slit disc. 1-5 Check Disconnection of cable.	4-2-2
		2. Check circuit board. 2-1 Replace of LCD- ** board ass'y. 2-2 Replace of TCÆboard.	4-1-1
		3. Sometimes needle bar doesn't work when start sewing. 3-1 Replace if cushion has been decrepit. 3-2 Replace of needle bar driver. 3-3 Adjust of jump device position. 3-5 Replace of Jump device. 3-6 Adjust position of Photo interrupter on Thread catcher.	3-2-4 3-2-5
	Operator	1. No thread is passed through detecting roller. 1-1 Pass thread properly.	(4-7)
		2. Is thread tension proper? 2-1 Observing sewing rhythm, adjust thread tension properly.	(4-5) (8-1)
		3. Is proper detection sensitivity of thread cut selected? 3-1 Select detection sensitivity according to sewing condition of thread and cloth etc.	(5-1)
	Environment	1. Is there any device to yield lints etc. around the embroidery. 1-1 Keep it off the embroidery machine. 1-2 Move the embroidery machine to other place.	
		2. Doesn't thread go beyond control by wind? (thread comes off from needle hole by loosing) 2-1 Keep thread off wind. 2-2 Move the embroidery machine to other place.	(2-6)
	Thread & Cloth	1. Isn't silicone agent used on thread? (Thread slips at detecting roller part due to adhere of silicone.) 1-1 Clean silicone agent attached to detecting roller groove.	

() ---Reference instruction book

Trouble shooting(Malfunction of thread break detection)

7-2-7

Trouble	Factor	Cause of trouble and measure	Page
Malfunction of thread break detection (not detected) (slow detected)	Mechanical	1. Check circuit board. 1-1 Replace of CONT-** board ass'y. 1-2 Replace of TCÆboard.	
	Operator	1. Is thread tension proper? 1-1 Observing sewing rhythm, adjust to proper thread tension. (Adjust it little bits stronger.)	(4-5) (8-1)
		2. Is proper detecting sensitivity of thread cut selected? 2-1 In case of being not detected, make [thread cut detection] setting to [yes]. 2-2 Select detection sensitivity of thread cut according to sewing condition of thread and cloth etc.	(15-1)

() ---Reference instruction book

Trouble shooting(Suspension of upper shaft)

7-2-8

Trouble	Factor	Cause of trouble and measure	Page
Suspension of main shaft (E-18) (E-51) (E-52)	Mechanical	1. Upper thread twine round rotary hook or rotary hook retainer. 1-1 Get rid of it.	
		2. Check return of keeper goes smooth. (when start sewing.) 2-1 Adjust it regularly.	3-6-12
		3. Check upper thread is sticking at thread guide part of bobbin case. 3-1 Get rid of it. 3-2 Do not use of bobbin case in which thread guide is coiled type. (use standard type)	
		4. Out of Needle bar block B from pressure foot block. 4-1 Insert needle bar block B into pressure foot block by doing needle bar change manually.	
		5. Defect on drive part of pressure foot. 5-1 Modify Pin B and hit part of link A and B by sand paper. 5-2 Replace of pressure foot block ass'y and link ass'y.	3-2-13
		6. Effect by breakage of parts. 6-1 Repair broken place.	
		7. No damage in electric parts? 7-1 Replace of CONT-** board ass'y. 7-2 Replace of Timing Board.	
		8. Trouble of software in LCD -** board ass'y. 8-1 Initialize, then make automatic speed setting.	(25-1) (25-2) 4-4-4
		9. Trouble in control of number of revolution. 9-1 Make automatic speed setting.	(25-2) 4-4-4
	Operator	1. Isn't foreign stuff such as thread or cloth caught in where revolution is driven. 1-1 Get rid of foreign stuff. 1-2 Stretch properly.	(6-2) (7-5)
		2. Isn't thread tension too strong (stop at time of action of thread cut)? 2-1 Weaken tension so as not to cause trouble in sewing rhythm.	(4-5) (8-1)
		3. Check condition of lubrication. 3-1 Lubricate (refer to message)	(23-1)
	Environment	1. Check adequate level of voltage. 1-1 Supply rated voltage. 100V – 115V -10V / +15V 200V – 230V -10V / +10V	

() ---Reference instruction book

Trouble shooting(Malfunction of needle bar change)

7-2-9

Trouble	Factor	Cause of trouble and measure	Page
Head does not move (E-021) (E-022)	Mechanical	1. Check lint or cloth is seized between Lower Moving rail and Bearing. 1-1 Remove seized lint or cloth.	
		2. Check lint or waste is seized in gap of Moving Cam. 2-1 Remove seized lint or waste.	
		3. Effect by breakage of parts. 3-1 Repair broken place.	
	Operator	1. Check Stopper of Moving Head is removed. 1-1 Remove Stopper.	
Uncontrollable Move (E-024) (E-025)	Mechanical	1. No problem in sensor circuit board ? 1-1 Clean dust attached to sensor. 1-2 Replace sensor circuit board.	4-2-1
		2. Needle number is not exactly recognized. 3-1 Check position of Photo interrupter on Needle bar change unit.	4-2-3
		3. Breakage of Pulse Motor . 4-1 Replace Pulse Motor.	

() ---Reference instruction book

Trouble shooting(Defect on Thread catcher)

7-2-10

Trouble	Factor	Cause of trouble and measure	Page
does not catch thread	Mechanical	1. Thead catcher does not extend hook sufficiently. 1-1 Adjust position of Thread catcher . 1-2 Adjust position of Thread holder.	3-2-18 3-3-13
		2. Excessive distance between Hook and tip of Needle. 2-1 Adjust position of Thread catcher. 2-2 Adjust position of Thread holder.	3-2-18 3-3-13
		3. Check Hook of Thread catcher bent or not. 1-1 Repair bent Hook. 1-2 Replace Hook.	
		2. Check position of Thread catcher is proper. 2-1 Adjust	3-2-18
Hook of Thread catcher does not extend	Mechanical	3. Check position of Thread holder is proper. 3-1 Adjust	3-3-13
		4. Check Thread catcher. 4-1 Check cable is securely connected. 4-2 Replace Pulse Motor with trouble.	
		5. Check CONT-** board ass'y. 5-1 Replace CONT-** board ass'y.	
		1. Check Hook is bent or not. 1-1 Repair bent Hook. 1-2 Replace Hook.	
		2. Check position of Thread catcher is proper. 2-1 Adjust	3-2-18
Hook hits or catches Needle (E-193)	Mechanical	3. Check position of Thread holder is proper. 3-1 Adjust	3-3-13
		1. Check if Needle is securely set. 1-1 Set Needle properly.	(4-1) 3-1-2
		Operator	
	Constant display of E-193	Mechanical	1. Trouble of Photo interrupter for Thread catcher. 1-1 Replace Photo interrupter.

() ---Reference instruction book

Trouble	Factor	Cause of trouble and measure	Page
Needle Breakage	Mechanical	1. Check Needle is not bent. 1-1 Replace bent Needle.	3-1-2
		2. Check Moving Head set securely. 2-1 Adjust Positioning Roller Shaft.	3-3-2
		3. Secure adequate distance between Needle and Rotary Hook. 3-1 Adjust distance properly.	3-5-1
	Operator	1. Is thread method in proper way? 1-1 Threading again in a proper way.	(4-6) (4-7)
		2. Check upper thread comes in a smooth way. (Thread stand, Thread tension point, double back etc) 2-1 Adjust place be caught in.	
		3. Check whether fabric is fixed firmly or not. 3-1 Hooping fabric firmly again.	(6-2) (7-5)
Defect of pressure foot movement	Mechanical	1. Check whether pressure foot and thread catcher holder touch each other or not. 1-1 Adjust installment position of thread catch holder. 1-2 In case pressure foot is fixed at an angle, fix it vertically again.	3-3-13
		2. Defect of censor circuit board for Pressure foot. 2-1 Replace of censor circuit board.	
Abnormal noise	Mechanical	1. By defect of cover installation. (Pressure foot drive, Carriage etc) 2-1 Take care of insert condition, clearance etc and fix again.	
		2. By lack of oil inside rotary hook. 2-1 Refuel 2-2 Replace of rotary hook	(23-1) 3-5-1
		3. Touching of cap switch bracket on X carriage to cover. 3-1 Adjust bend of bracket.	
Big noise	Mechanical	1. Gap between pressure foot block and needle bar boss B. 1-1 Replace of pressure foot block.	3-2-13
		2. Bearing gap of take up crank ass'y. 2-1 Adjust bearing. 2-2 Replace of bearing.	3-2-7
		3. Gap between take up lever ass'y and take up clank ass'y. 3-1 Replace of take up lever ass'y. 3-2 Replace of take up lever crank ass'y	3-3-9

() ---Reference instruction book

Trouble	Factor	Cause of trouble and measure	Page
Frame overrun	Mechanical	1. Interference between censor circuit board and douser. 1-1 Position adjustment of douser. 1-2 Replace of censor circuit board.	
		2. Check whether cable has problem or not. 2-1 Replace in case damage exists. 2-2 Insert connector again.	
		3. Check CONT-** board ass'y. 3-1 Replace of CONT-** board ass'y.	
Key on control box can not be pressed down and returned	Mechanical	1. When removing panel in replacing circuit board , due to poor cable bundling, circuit board being pushed from inside. 1-1 Bundle cable again	
Defect of LCD	Mechanical	1. Check LCD . 1-1 Replace of LCD	4-1-1
		2. Inadequate condition of cable insertion 2-1 Insert to the back firmly.	
		3. Check whether LCD-** board ass'y is out of order or not. 3-1 Replace of LCD-** board ass'y.	4-1-1
Defect of data communication (E-90) (E-91)	Mechanical	1. Check whether cable (USB or LAN) is insert firmly between PC and Machine. 1-1 Insert again	
		2. Check whether PC has problem or not. 2-1 Affirm whether there is problem or not.	
		3. Check whether LCD-** board ass'y is out of order or not. 3-1 Replace of LCD-** board ass'y .	4-1-1
Pattern disappears / Watch doesn't indicate time	Mechanical	1. Trouble in back-up battery on LCD-** board ass'y 1-1 Replace of LCD-** board ass'y .	4-1-2
		2. No trouble in memory tip on LCD-** board ass'y ? 2-1 Conduct [memory all clear] in maintenance mode. 2-2 If above measure doesn't solve the trouble, replace LCD-** board ass'y.	4-5-3

() ---Reference instruction book

Startup error and measure

Error message will be displayed if error occurs during machine startup.

After confirming contents, press button [OK] on control box to release error, then restore in accordance with measure in this list.

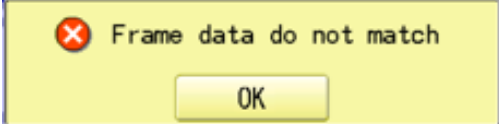
Message	Error	Measure
	<p>Exchanged control box or CONT board does not match for the installed data of [Machine setting].</p>	<p>When only control box has been exchanged, open the menu of [4-5-4-5 Setup — Machine setting] and just close without any amendment.</p> <p>When CONT board has been exchanged, follow the procedure of [4-5-4-7 Machine Setting Navigation after exchanging CONT board].</p>
	<p>Installed frame drive data in the machine does not match.</p>	<p>Check setting contents of [Machine setting] by referring [4-5-4-5 Setup—Machine setting], then follow the procedure [4-4-3Machine program update].</p>

Error and measure

7-3-2

When trouble occurred while the machine is running, error number and error item will be displayed. After confirming contents, press key [ENT.] on control box to release error, then restore in accordance with measure in this list.

No.	Message	Error	Measure	Page
001	Circuit board	Trouble detected in control circuit board.	(1)Turn power off once and turn on again. (2)If recurred, replace LCD-** board ass'y.	
004	System memory	Trouble in system memory.	Replace LCD-** board ass'y.	
018	Main shaft	Suspension of main shaft in mid way.	(1)Check if trouble found between main shaft and drive. If trouble found, restore. (2)If recurred, find cause and fix. (3)Make automatic speed setting again. Initializing	(25-1) (25-2)
020	Needle detect	Needle position not detected. Trouble in stop position of needle selection unit.	(1)Turn needle selection cam by hand to set to regular position. (2)Fix needle selection related mechanical trouble. (3)Replace sensor circuit board.	4-2-3
021 022	Needle move	Suspension of needle selection motor in mid way. Trouble in take-up lever hinders. Trouble in sensor circuit board	(1)Turn needle selection cam by hand to set to regular position. (2)Fix needle selection related and take up lever related troubles. (3)Replace sensor circuit board.	4-2-3
024	Needle center	Stop position of needle bar is off center	(1)Turn needle selection cam by hand to set to regular position. (2)If trouble occurs repeatedly, fix mechanical trouble in needle selection & its vicinity.	
025	Needle over	Specified needle number went beyond needle number of the machine.	Adjust position of needle selection cam and Photo interrupter on Needle bar change unit.	5-5-1
026	Needle differ	As needle number differed from memory when power turned on, it was renewed.	(1)Turn power off once and turn on again. (2)Let the machine recognize needle number.	5-5-1

() ---Reference instruction book

No.	message	Error	measure	page
030	Slow mismatch	Inadequate adjustment of number of low speed revolution. Low speed revolution doesn't come below 100rpm.	(1)Make automatic speed setting. Initializing (2)If not solved even after speed adjustment, replace CONT-** board ass'y..	(25-1) (25-2)
050	C point	Main shaft stops off its position.	Turn main shaft to plus direction to set to C point.	(24-4)
051	L sensor	Poor lowest needle position sensor on timing detecting circuit board. Damage in timing detecting circuit board, stained photo sensor, poor adjustment of slit disc.	(1)If photo sensor is stained, clean. (2)Adjust timing. (3)Replace main shaft timing circuit board. (4) Initializing, Initializing of machine speed	4-2-1 (25-1) (25-2)
052	C sensor	Damage in color change point sensor on timing circuit board. Damage in timing detecting circuit board, stained photo sensor, poor adjustment of slit disc.		
060	X limit	Drive frame went beyond limits in X direction.	(1)Move drive frame back to limits with move key.	
061	Y limit	Drive frame went beyond limits in Y direction.	(2)Correct pattern size and setting contents.	
090	Miss reception	Error occurred when transmitting data.	Let the machine read pattern data from first.	(5-4)(5-6)
091	No send	Data is not put in for over 10 seconds.	Let the machine read data from first.	(5-4)(5-6)
103	Data format	The machine can't judge format of pattern data.	(1)Check format of pattern data. (2)By setting reading of pattern data, set format properly.	(5-6) (10-3)
104	Miss function	Timing to read pattern data doesn't conform.	Read pattern data again from the first.	(5-4) (5-6)
105	Dual function	One stitch data has more than 2 functions.	(1)Read pattern data again from the first. (2)Check and modify the design data if there is wrong.	(5-6) (10-3)
108	Improper read	While reading pattern data, there accrued error in internal processing.	Read pattern data again from the first.	(5-4) (5-6)
110	Memory full	While reading pattern data, memory exceeded its capacity.	Delete unnecessary patterns and read from the outset.	(5-5)(5-B) (23-1)

() ---Reference instruction book

No.	message	Error	measure	page
111	Change over	While reading pattern data, the frequency of color change (color No.) exceeded 250 times.	(1)Modify pattern data and reduce frequency of color change of one pattern to less than 250 times. (2)Divide pattern data and reduce frequency of color change of one pattern to less than 250 times.	
112	Data error	Pattern data of pattern to be embroidered is damaged.	(1)Read pattern data again from the first. (2)Read pattern data again if you have a backup data.	(5-4)(5-6)
114	Id over	The number of pattern in memory has reached maximum of 3000.	Delete unnecessary patterns and read.	(5-5) (5-B)
118	Trace data over	The stitch number counts over 1024 stitches during preparing Trace data.	Set Embroidery area of pattern data within 2m(X) x 2m(Y).	
120	Memory error	It became impossible to retain contents of memory.	(1)Turn power off once and turn on again. (2)If problem recurs frequently, replace SD memory or LCD-** board.	4-1-2 4-1-1
130	Card error	Incapable of disposing of USB memory continuously.	(1)Turn off power source once and turn it on again. (2)USB Memory reading processor may defective. Replace the circuit board.	
131	Card no ready	USB Memory is not set.	Check if USB memory is properly set.	(5-5)
133	Bad card	USB Memory is not proper or broken.	(1)USB Memory might be not readable with the machine. Prepare readable USB memory for the machine. (2)USB Memory card might be defective. Prepare another memory card which is not defective. (3)Initialize the USB memory if it is not initialized.	(5-5)
141	Not found name	Designated pattern is not found.	USB Memory might be not readable with the machine. Prepare readable USB memory for the machine.	(5-5)
190	Cut blade	Thread cut knife is not at stop position.	(1)Restore the moving knife to stop position. (2)Modify the adjustment if the problem repeats.	(24-5)
193	Catcher	Thread catch hook is not in its stop position.	(1)Check if mistake is found in thread cut. If found, cut thread and move thread catch hook to proper position. (2)Adjust and correct trouble that hinders motion of thread catch hook.	(24-6)

() ---Reference instruction book

		Tables for Timing/Adjustment value
Take-up lever timing		10 degrees
Rotary hook timing		25 degrees
Needle height		5 degrees
Main shaft timing	L	LED2 light out at 0 degrees
	C	LED1 light on at 265-282 degrees
Carriage	X	500cN
	Y	500cN
Timing belt		-
Motor belt		320 – 330 g

You can use TAJIMA made tubular frame which has the same installation width (space between left and right positioning pin) as HAPPY's frame by changing the position of both left and right hold springs and left and right hold spring bases. Follow the procedure below after removing tubular frame.

1. Loosen screws (2 each at both left and right).
2. Move both left and right hold spring bases deep into screws.
3. Move both left and right hold springs forward until the spring touches screws and stops moving.
4. Tighten screws (2 each at both left and right).
5. Install tubular frame and check if the tip of both left and right hold springs enters receiving hole on tubular frame.

If the tip dose not enter receiving hole, loosen screw, rotate hold springs left or right so that the tip can enter the hole, and tighten screw.
Please reverse the procedure above when returning to the position of something before change has been made.

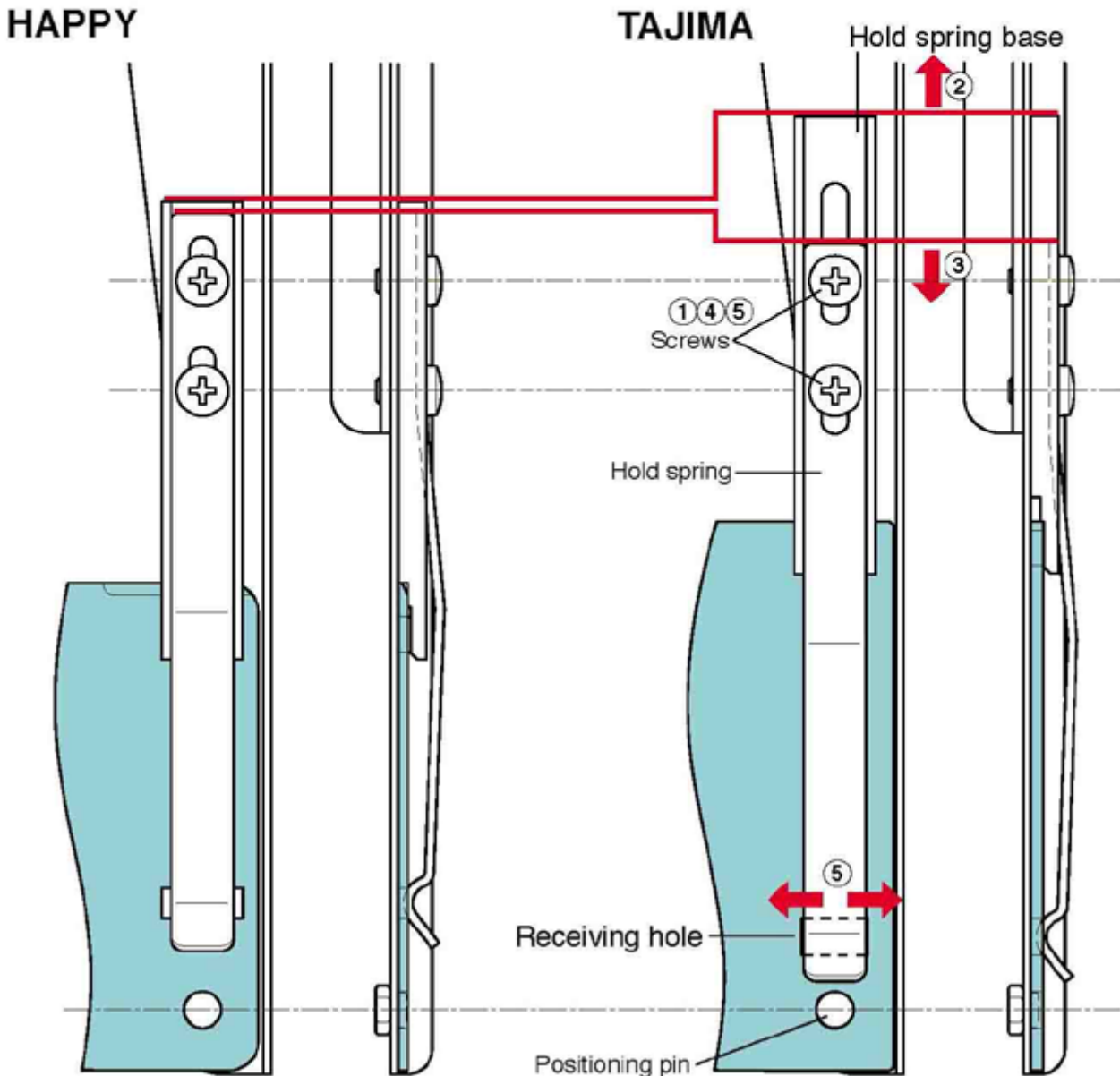



HappyJapan Inc.

9-5. TAITO 2-CHOME, TAITO-KU, TOKYO, JAPAN

TEL +81-3-3834-0711

FAX +81-3-3835-8917